



InnovaMass 240i / 241i

InnovaMass[®] iSeries

Models 240i & 241i

Vortex Volumetric Flow &
Multivariable Mass Vortex Flow Meters

Instruction Manual



Part Number: 24i-IM
Version B, December 2015



SIERRA[®]

GLOBAL SUPPORT LOCATIONS: WE ARE HERE TO HELP!

For Global Service Centers, go to
<http://www.sierrainstruments.com/facilities.html>

CORPORATE HEADQUARTERS

5 Harris Court, Building L Monterey, CA 93940
Phone (831) 373-0200 (800) 866-0200 Fax (831) 373-4402
info@sierrainstruments.com
www.sierrainstruments.com

EUROPE HEADQUARTERS

Bijlmansweid 2 1934RE Egmond aan den Hoef
The Netherlands
Phone +31 72 5071400 Fax +31 72 5071401
sales@sierrainstruments.nl

ASIA HEADQUARTERS

Second Floor Building 5, Senpu Industrial Park
25 Hangdu Road Hangtou Town
Pu Dong New District, Shanghai, P.R. China
Postal Code 201316
Phone: + 8621 5879 8521 Fax: +8621 5879 8586

IMPORTANT CUSTOMER NOTICE- OXYGEN SERVICE

Unless you have specifically ordered Sierra's optional O₂ cleaning, this flow meter may not be fit for oxygen service. Sierra Instruments, Inc., is not liable for any damage or personal injury, whatsoever, resulting from the use of Sierra Instruments standard mass flow meters for oxygen gas. You are responsible for cleaning the mass flow meter to the degree required for your oxygen flow application. **However, some models can only be properly cleaned during the manufacturing process.**

© COPYRIGHT SIERRA INSTRUMENTS 2015

No part of this publication may be copied or distributed, transmitted, transcribed, stored in a retrieval system, or translated into any human or computer language, in any form or by any means, electronic, mechanical, manual, or otherwise, or disclosed to third parties without the express written permission of Sierra Instruments. The information contained in this manual is subject to change without notice.

TRADEMARKS

InnovaMass[®], qTherm[®], Dial-a-Gas[™], Dial-a-Pipe[™], MassBalance[™] and Raptor II[™] are trademarks of Sierra Instruments, Inc. Other product and company names listed in this manual are trademarks or trade names of their respective manufacturers.

Table of Contents

Chapter 1: Introduction	7
Chapter 2: Installation <i>Installation Overview</i>	13
Chapter 3: Operation & Programming.....	34
Chapter 4: Troubleshooting & Repair.....	82
Appendix A: Product Specifications	85
Appendix B: Flow Meter Calculations	97
Appendix: C Glossary	99
Appendix D: ATEX and IECEx Certified EX Units.....	102
Appendix E: Warranty Policy	115



Get detailed instructions on the **Smart Interface Portal (SIP) software** in the [Smart Interface Portal instruction manual](#).



Warnings and Cautions

Note and Safety Information

We use caution and warning statements throughout this book to draw your attention to important information.

General Safety Information

We use caution and warning statements throughout this book to draw your attention to important information.

Symbol Key		
Symbol	Symbol Meaning	Description
	Warning	This statement appears with information that is important to protect people and equipment from damage. Pay very close attention to all warnings that apply to your application.
	Caution	This statement appears with information that is important for protecting your equipment's performance. Read and follow all cautions that apply to your application.



Warning!

- Consult the flow meter nameplate for specific flow meter approvals before any hazardous location installation.
- Hot tapping must be performed by a trained professional. U.S. regulations often require a hot tap permit. The manufacturer of the hot tap equipment and/or the contractor performing the hot tap is responsible for providing proof of such a permit.
- All flow meter connections, isolation valves and fittings for cold/hot tapping must have the same or higher pressure rating as the main pipeline.
- For insertion flow meter installations, an insertion tool must be used for any installation where a flow meter is inserted under pressure greater than 50 psig.
- To avoid serious injury, DO NOT loosen a compression fitting under pressure.
- To avoid potential electric shock, follow National Electric Code or your local code when wiring this unit to a power source. Failure to do so could result in injury or death. All AC

power connections must be in accordance with published CE directives. All wiring procedures must be performed with the power off.

- Before attempting any flow meter repair, verify that the line is not pressurized. Always remove main power before disassembling any part of the mass flow meter.
- When using toxic or corrosive gases, purge the line with inert gas for a minimum of four hours at full gas flow before installing the flow meter.



Caution!

- Calibration must be performed by qualified personnel. Sierra strongly recommends that you return your flow meter to the factory for calibration.
- In order to achieve accurate and repeatable performance, the flow meter must be installed with the specified minimum length of straight pipe upstream and downstream of the flow meter's sensor head.
- For insertion flow meter installations, the sensor alignment pointer must point downstream in the direction of flow.
- The AC wire insulation temperature rating must meet or exceed 85°C (185°F)

Receipt of System Components

When receiving a Sierra mass flow meter, carefully check the outside packing carton for damage incurred in shipment. If the carton is damaged, notify the local carrier and submit a report to the factory or distributor. Remove the packing slip and check that all ordered components are present. Make sure any spare parts or accessories are not discarded with the packing material. Do not return any equipment to the factory without first contacting Sierra Customer Service.

Technical Assistance

If you encounter a problem with your flow meter, review the configuration information for each step of the installation, operation, and setup procedures. Verify that your settings and adjustments are consistent with factory recommendations. Installation and troubleshooting information can be found in the Chapter 2 (Installation) and Chapter 4 (Troubleshooting) of this manual.

If the problem persists after following the troubleshooting procedures outlined in Chapter 4 of this manual, contact Sierra Instruments by fax or by e-mail (see inside front cover). For urgent phone support you may call (800) 866-0200 or (831) 373-0200 between 8:00 a.m. and 5:00 p.m. PST. In Europe, contact Sierra Instruments Europe at +31 72 5071400. In the Asia-Pacific region, contact Sierra Instruments Asia at +8621 5879 8521. When contacting Technical Support, make sure to include this information:

- The flow range, serial number, and Sierra order number (all marked on the meter nameplate)
- The software version (visible at start up)
- The problem you are encountering and any corrective action taken
- Application information (gas, pressure, temperature and piping configuration)

Using This Manual

This manual provides information needed to install and operate both the 240i Inline and 241i Insertion InnovaMass vortex flow meters.

- Chapter 1 includes the introduction and product description
- Chapter 2 provides information needed for installation
- Chapter 3 describes system operation and programming
- Chapter 4 covers troubleshooting and repair
- Appendix A - Product Specifications
- Appendix B - Flow Meter Calculations
- Appendix C – Glossary
- Appendix D - ATEX and IECEx Certified EX Units
- Appendix E – Warranty Policy

Register Your Product Today

Warranty Statement

All Sierra products are warranted to be free from defects in material and workmanship and will be repaired or replaced at no charge to Buyer, provided return or rejection of product is made within a reasonable period but no longer than one (1) year for calibration and non-calibration defects, from date of delivery. To assure warranty service, customers must register their products online on Sierra's website. Online registration of all of your Sierra products is required for our warranty process.

Read complete warranty policy at www.sierrainstruments.com/warranty

Register Warranty Online

Register now at www.sierrainstruments.com/register. Learn more about Sierra's warranty policy at www.sierrainstruments.com/warranty

Chapter 1: Introduction

InnovaMass. Reinvented.

In the 1990s, Sierra designed and introduced InnovaMass, the first multivariable mass vortex flow meter in the world. Through a single process connection, InnovaMass now empowered customers with mass flow rate, volumetric flow rate, density, temperature and pressure. Five instruments in one.

InnovaMass' innovative new features introduced a welcome force-multiplier. With five high accuracy measurements available from a single device, total cost-of-ownership plummeted. Lower initial cost, less complex installation, and reduced maintenance costs contributed to significant customer savings.

Today, with the latest hyper-fast microprocessors, robust software applications, and our new automated state-of-the-art flow calibration facility, the completely re-designed InnovaMass 240i/241i "iSeries" delivers precision, performance, and application flexibility never before possible.

The Vortex "i" Series Introduces Comprehensive Flow Energy Management

To meet process control demands, flow energy in the form of steam, compressed air, natural gas and water must be measured and managed with greater precision than ever before. Increased control over resulting flow energy costs drives increased productivity and competitiveness.

The reinvented InnovaMass 240i and 241i delivers a revolution in flow energy management with these new iSeries features:

- Raptor II microprocessor is 10x faster to run robust software applications
- Field diagnostics, validation, and adjustment through onboard Smart Interface Portal
- Rapid update of latest features with field firmware upgrade capability
- FloPro™ software application improves point-velocity accuracy for insertion version
- Complete suite of digital communications for turnkey networking & automation
- Patented MassBalance™ sensor in tandem with Raptor II for mechanical and digital signal processing breakthroughs

240i Inline/241i Insertion

- Mass or volumetric flow monitoring of gases, liquids and steam
- Measures five process variables with one process connection: mass flow, volumetric flow, density, pressure, temperature
- Insertion version for 2 inch (50.8 mm) or greater; inline to 8 inches (DN 200)
- Accuracy of up to 0.7% of reading; temperature to 392 °F (200 °C); pressure to 750 psig (50 barg)
- Raptor II OS flow engine builds and measures complex liquid and gas mixtures
- Raptor II OS and MassBalance technology extends range down to Reynold's numbers below 5000
- Smart Interface Portal assures field validation and allows for easy configuration
- Datalogging capability
- Dial-A-Pipe™: Change pipe size in the field
- Dial-A-Fluid™: Change fluid in the field
- Three configurable 4-20 outputs

- Multiple languages
- HART, Modbus, Profibus DP, Foundation Fieldbus, USB, RS-232
- AGA-8 density equations
- Approvals: CE, cFMus, ATEX, PED, IECEx

Raptor II OS Flow Engine Powers Advanced Field Flexibility

Originally developed as the operating system for our QuadraTherm thermal mass flow meter, Raptor II OS is the “flow-engine” inside every InnovaMass iSeries vortex meter. Raptor II uses advanced digital signal processing and proprietary mathematical algorithms to enhance the flow signal, while also calculating the thermodynamic properties of the gas, liquid or steam being measured in real-time.

Raptor II accomplishes the following:

- Easily manages all five process variables in real time
- It has Apps: Robust field flexibility with applications like FloPro, Dial-A-Pipe, Dial-A-Fluid, and ValidCal Diagnostics
- Allows for field firmware upgrades of latest features and improvements
- Real-time adjustments for temperature, pressure, density, or compressibility variations improves application flexibility
- Improves the overall accuracy and flow range with improved external noise cancellation
- Enhances velocity signal for greater sensitivity at low flows
- Interfaces with the Smart Interface Portal software to read and adjust the meter in the field
- Includes a fluid database with nearly all liquids, gases, and complete steam tables
- Manages real-time fluid density and viscosity (including AGA-8) calculation
- Enables creation of unique fluid mixtures with qMix

The Vortex Principle Features Nature’s Magic

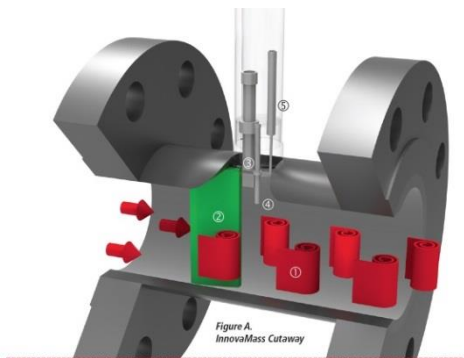

Figure A: InnovaMass Cutaway

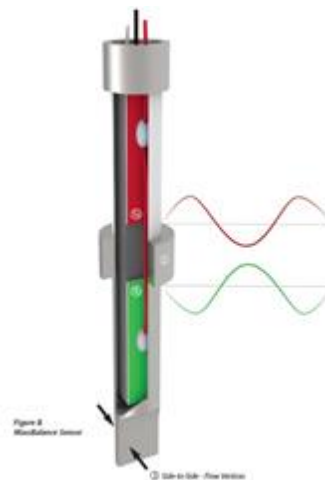

Figure B: Out Of Phase Vibration Signals

Very similar to the way a tree branch in a fast-flowing stream creates swirls or vortices in the downstream flow, Figure A shows the alternating vortices (1) shed by the bluff body (2) inside every InnovaMass. These vortices flex the instrument piezoelectric sensor tab (3), producing a frequency output that is directly proportional to the flow rate.

Multivariable mass flow is achieved when a temperature sensor (4) is immersed in the flow stream to measure the temperature of the flowing gas, liquid or steam. Simultaneously, a pressure sensing port (5) leads up to an isolated pressure transducer.

MassBalance™ Sensor

Figure B takes a close-up view of (3) in Figure A above. This cutaway view of the sensor features our patented MassBalance technology which works mechanically with DSP (Digital Signal Processing) to cancel out external vibration influences. The MassBalance sensor has two sensing beams (1 a & 1 b) isolated from each other by a mechanical ground (2). A piezoelectric crystal is mounted inside the vortex-sensing beam (1 b) in a cantilevered (fixed at one end) fashion in the flow path for sensing vortices shed from the bluff body. A second piezoelectric crystal is mounted in a vibration-sensing beam (1 a), for sensing external vibrations only, extending in a cantilevered fashion away from the vortex-sensing beam. The vortices formed by the flow around the shedder bar push the sensor tab (3) “side-to-side,” flexing the piezoelectric crystals and causing them to generate a voltage pulse with a frequency proportional to the flow rate.

The entire assembly is affected by vibration. Vibration affects sensor 1 a and 1 b equally, so the two sets of piezoelectric crystals are configured to cancel out the vibration signal while only sensor 1 b feels the “side-to-side” flow signal.

The waveforms above illustrate the vibration signals from the two opposing sensing beams inside the MassBalance sensor. They are designed to be 180° out of phase from each other and when added together effectively eliminate the vibration component. The sensor is mechanically balanced and provides a very clean flow velocity signal where it undergoes advanced digital signal processing. This clean velocity signal leads to enhanced noise and vibration rejection, allowing measurement sensitivity at low flows.

The Flexibility of Insertion

The 241i insertion vortex meter is an economical solution for applications from 2-inch (50.8mm) pipes to 72 inches (1.8 M) in diameter and larger. Volumetric or multivariable measurement is possible with a single pipe insertion point, greatly reducing installation costs (Figure B). The 241i can be hot tapped into applications with an optional probe retractor (shown right). More compact probe lengths are available based on application requirements.



Raptor II OS Enhances Accuracy with FloPro™

Driven by Raptor II OS, the 241i insertion has a vastly improved flow profile calculation using a proprietary application called FloPro. With all insertion point velocity flow meters, knowing the flow profile inside the pipe or duct is key to stable and reliable accuracy. Traditional insertion meters use a simple formula from Miller that calculates flow profile assuming turbulent flow only.

FloPro makes no assumptions. It applies a sophisticated mathematical calculation for higher resolution and understanding of flow profile. In addition to turbulent flow, FloPro calculates

laminar and transitional flow in real-time as they would occur inside the pipe or duct (See Figure C). This results in increased accuracy, particularly at low flow rates of Reynolds Number of 5000 and below.

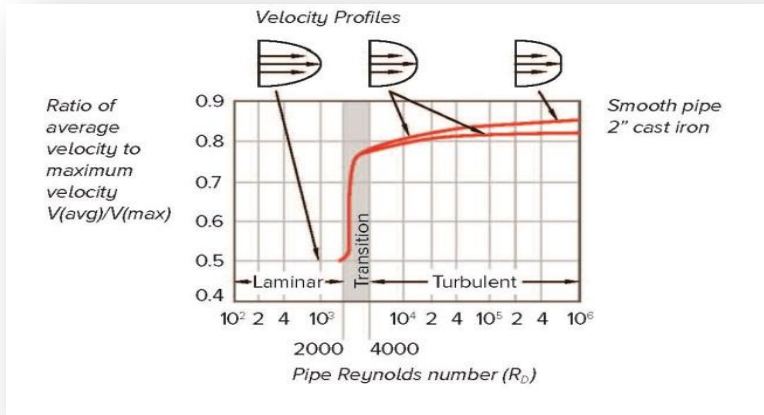

Figure C. Ratio of Laminar, Transitional and Turbulent flow regimes and Reynolds number
(Source: Richard Miller, Flow Measurement Engineering Handbook.)

Flow Velocity Range

To ensure trouble-free operation, vortex flow meters must be correctly sized so that the flow velocity range through the meter lies within the measurable velocity range (with acceptable pressure drop) and the linear range.

The measurable range is defined by the minimum and maximum velocity using the following table.

	Gas	Liquid	
Vmin	$\sqrt{\frac{25}{\rho}} \text{ ft/s}$	1 ft/s	English ρ (lb/ft ³)
Vmax	300 ft/s	30 ft/s	
Vmin	$\sqrt{\frac{37}{\rho}} \text{ m/s}$	0.3 m/s	Metric ρ (kg/m ³)
Vmax	91 m/s	9.1 m/s	

Figure D. Flow Velocity Range

The pressure drop for series 241i insertion meters is negligible. The pressure drop for 240i Series inline meters is defined as:

$$\Delta P = .00024 \rho V^2 \quad \text{English units } (\Delta P \text{ in psi, } \rho \text{ in lb/ft}^3, V \text{ in ft/sec})$$

$$\Delta P = .000011 \rho V^2 \quad \text{Metric units } (\Delta P \text{ in bar, } \rho \text{ in kg/m}^3, V \text{ in m/sec})$$

The linear range is defined by the Reynolds number. The Reynolds number is the ratio of the inertial forces to the viscous forces in a flowing fluid and is defined as:

$$\text{Re} = \frac{\rho V D}{\mu}$$

Where

Re = Reynolds Number
 ρ = mass density of the fluid being measured
V = velocity of the fluid being measured
D = internal diameter of the flow channel
 μ = viscosity of the fluid being measured

The Strouhal number is the other dimensionless number that quantifies the vortex phenomenon. The Strouhal number is defined as:

$$\text{St} = \frac{f d}{V}$$

Where

St = Strouhal Number
f = frequency of vortex shedding
d = shedder bar width
V = fluid velocity

InnovaMass meters exhibit a constant Strouhal number across a large range of Reynolds numbers, indicating a consistent linear output over a wide range of flows and fluid types. Below this linear range, the intelligent electronics in InnovaMass automatically corrects for the variation in the Strouhal number with the Reynolds number. The meter's smart electronics corrects for this non-linearity via its simultaneous measurements of the process fluid temperature and pressure. This data is then used to calculate the Reynolds number in real time.

Temperature Measurement

InnovaMass flow meters use a 1000 ohm platinum resistance temperature detector (PRTD) to measure fluid temperature.

Pressure Measurement

InnovaMass flow meters incorporate a solid-state pressure transducer isolated by a 316 stainless steel diaphragm. Digital compensation allows these transducers to operate within a 0.5% of full scale accuracy band within the entire ambient temperature range of -40°F to 140°F (-40 to 60°C). Thermal isolation of the pressure transducer ensures the same accuracy across the allowable process fluid temperature range of -40°F to 392°F (-40 to 200°C).

Flow Meter Configurations

InnovaMass Vortex Mass Flow Meters are available in two model configurations:

- 240i Series inline flow meter (replaces a section of the pipeline)
- 241i Series insertion flow meter (requires a compression fitting, packing gland, or probe retractor to “cold” tap or a “hot” tap into an existing pipeline)

Both the inline and insertion configurations are similar in that they both use identical electronics and have similar sensor heads. Besides installation differences, the main difference between an inline flow meter and an insertion flow meter is their method of measurement.

For an inline vortex flow meter, the shedder bar is located across the entire diameter of the flow body. Thus, the entire pipeline flow is included in the vortex formation and measurement. The sensing head, which directly measures velocity, temperature and pressure is located just downstream of the shedder bar.

Insertion vortex flow meters have a shedder bar located across the diameter of a short tube. The velocity, temperature and pressure sensor are located within this tube just downstream of a built-in shedder bar. This entire assembly is called the insertion sensing head. It fits through any entry port with a 1.875 inch minimum internal diameter.

The sensing head of an insertion vortex flow meter directly monitors the velocity at a point in the cross-sectional area of a pipe, duct, or stack (referred to as “channels”). The velocity at a point in the pipe varies as a function of the Reynolds number. The insertion vortex flow meter computes the Reynolds number and then computes the total flow rate in the channel. The output signal of insertion meters is the total flow rate in the channel. The accuracy of the total flow rate computation depends on adherence to the piping installation requirements given in Chapter 2. If adherence to those guidelines cannot be met, contact the factory for specific installation advice

Multivariable Options

The 240i or 241i models are available with the following options: V, volumetric flow meter; VT, velocity and temperature sensors; VTP, velocity, temperature, and pressure sensors.

Line Size/Process Connections/Materials

The 240i Inline model is built for line sizes 1 through 8-inch flanged design using ANSI 150, 300, 600 or DN PN 16, 40, or 64 class flanges.

The 241i insertion model can be used in line sizes 2 inch and greater and is built with a compression fitting or packing gland design using 2-inch NPT, or 2-inch flanged connections (ANSI 150, 300, 600 or DN PN16, 40, or 64 class flanges). The packing gland design can be ordered with a retractor.

InnovaMass flow meter electronics are available mounted directly to the flow body, or remotely mounted. The electronics housing may be used indoors or outdoors, including wet environments. Available input power options are DC or AC powered. Three analog output signals are available for flow rate, temperature, and pressure. An alarm relay output, a pulse output signal for remote totalization and RS-232, USB, Modbus, HART, Profibus DP, and Foundation Fieldbus communications are also available.

InnovaMass flow meters include a local 2 x 16 character LCD display housed within the enclosure. Local operation and reconfiguration is accomplished using six pushbuttons operated via finger touch. The electronics include nonvolatile memory that stores all configuration information. The nonvolatile memory allows the flow meter to function immediately upon power up, or after an interruption in power. All flow meters are calibrated and configured for the customer's flow application.

Chapter 2: Installation

Installation Overview

Sierra's InnoMass Vortex Flow Meter installations are simple and straightforward. Both the 240i Inline and 241i Insertion type flow meter installations are covered in this chapter. After reviewing the installation requirements given below, see page 14 for 240i installation instructions. See page 16 for 241i installation instructions. Wiring instructions begin on page 23.

Flow Meter Installation Requirements

Before installing the flow meter, verify the installation site allows for these considerations:

1. Line pressure and temperature will not exceed the flow meter rating.
2. The location meets the required minimum number of pipe diameters upstream and downstream of the sensor head as illustrated in Figure 1, page 14.
3. Safe and convenient access with adequate overhead clearance for maintenance purposes.
4. Verify that the cable entry into the instrument meets the specific standard required for hazardous area installations. The cable entry device shall be of a certified flameproof type, suitable for the conditions of use and correctly installed. The degree of protection of at least IP66 to EN 60529 is only achieved if certified cable entries are used that are suitable for the application and correctly installed. Unused apertures shall be closed with suitable blanking elements.
5. For remote installations, verify the supplied cable length is sufficient to connect the flow meter sensor to the remote electronics.



Consult the flow meter nameplate for specific flow meter approvals before any hazardous location installation.

Also, before installation check your flow system for anomalies such as:

- leaks
- valves or restrictions in the flow path that could create disturbances in the flow profile that might cause unexpected flow rate indications

Unobstructed Flow Requirements

Select an installation site that will minimize possible distortion in the flow profile. Valves, elbows, control valves and other piping components may cause flow disturbances. Check your specific piping condition against the examples shown below. In order to achieve accurate and repeatable performance install the flow meter using the recommended number of straight run pipe diameters upstream and downstream of the sensor.

Note: For liquid applications in vertical pipes, avoid installing with flow in the downward direction because the pipe may not be full at all points. Choose to install the meter with flow in the upward direction if possible.

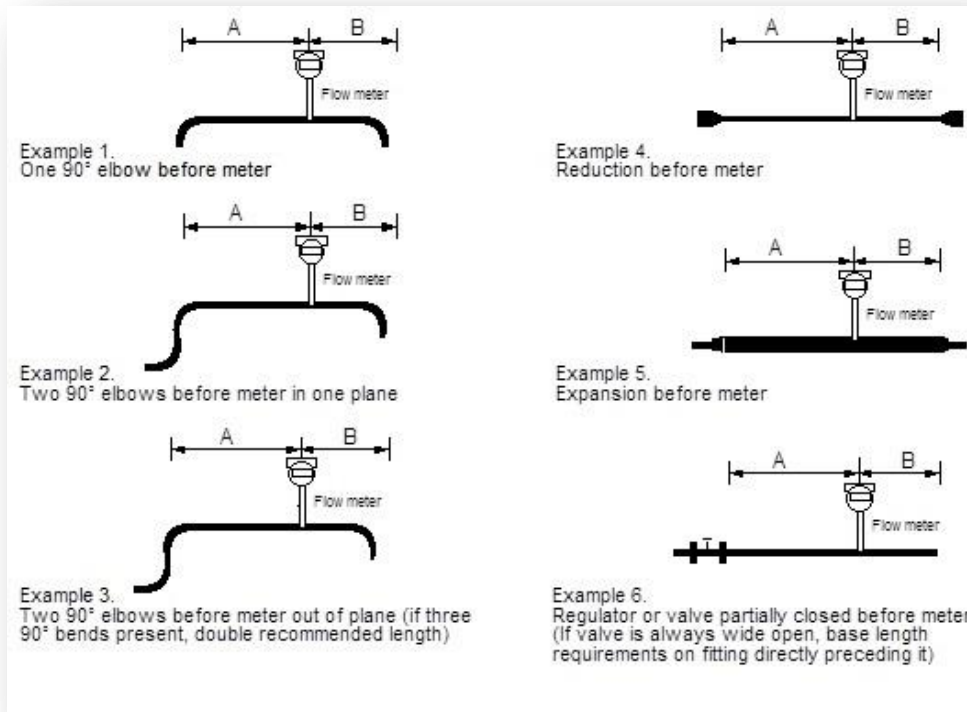

	Minimum Required Upstream Diameters	Minimum Required Downstream Diameters
Example	A	B
1	10 D	5 D
2	15 D	5 D
3	25 D	10 D
4	10 D	5 D
5	20 D	5 D
6	25 D	10 D
D=Internal diameter of channel. N/A=Not applicable		

Figure 1: Recommended Pipe Length Requirements for Installation, 240i/241i Series

240i Inline Flow Meter Installation

Unless otherwise noted on the application datasheet (ADS), the meter inside diameter is equal to the same size nominal pipe ID in schedule 80. For example, a 2-inch meter has an ID of 1.939 inches (2 inch schedule 80). **Do not install the meter in a pipe with an inside diameter smaller than the inside diameter of the meter.** For schedule 160 and higher pipe, a special meter is required. Consult the factory before purchasing the meter.

The InnovaMass 240i meters require customer-supplied gaskets. When selecting gasket material make sure that it is compatible with the process fluid and pressure ratings of the specific installation. Verify that the inside diameter of the gasket is larger than the inside diameter of the flow meter and adjacent piping. If the gasket material extends into the flow stream, it will disturb the flow and cause inaccurate measurements.

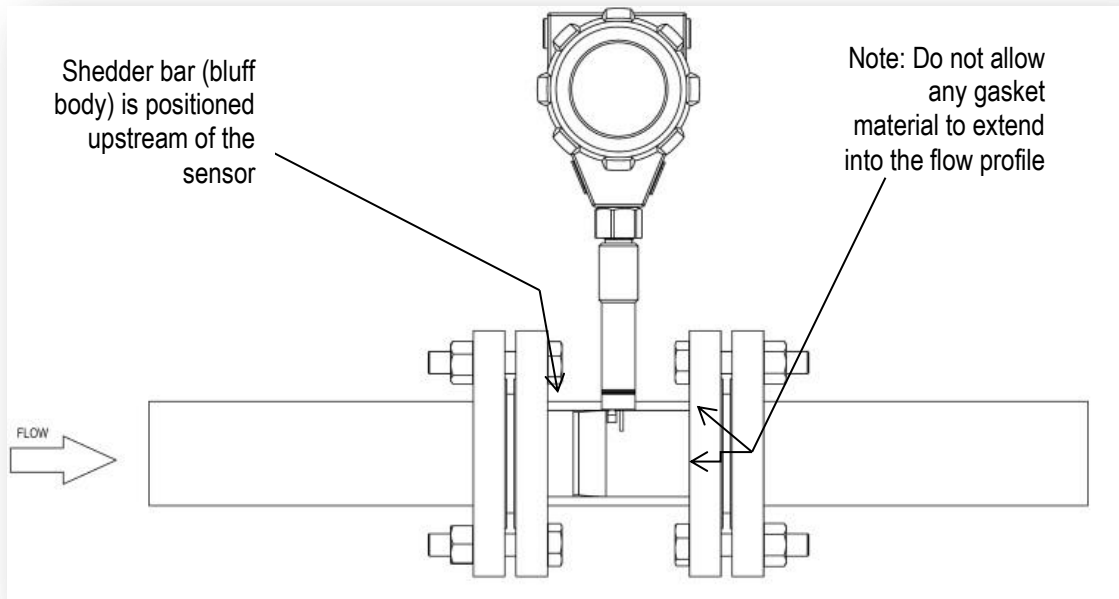



Figure 2. Flange-Style Flow Meter Installation

Flange-Style Flow Meter Installation

Install the flange-style meter between two conventional pipe flanges of the same nominal size as the flow meter. If the process fluid is a liquid, make sure the meter is located where the pipe is always full. This may require locating the meter at a low point in the piping system.

	<p>Vortex flow meters are not suitable for two-phase flows (i.e., liquid and gas mixtures). For horizontal pipelines having a process temperature above 300° F (149°C), mount the meter at a 45 or 90-degree angle to avoid overheating the electronics enclosure.</p>
---	--

	<p>When using toxic or corrosive gases, purge the line with inert gas for a minimum of four hours at full gas flow before installing the flow meter.</p>
---	--

When installing the meter make sure the body marked with a flow arrow is positioned with the arrow head pointing in the direction of flow. Installing the meter opposite this direction will result in completely inaccurate flow measurement. To install the meter:

1. Turn off the flow of process gas, liquid or steam. Verify that the line is not pressurized. Confirm that the installation site meets the required minimum upstream and downstream pipe diameters.

2. Seat the meter level and square on the mating connections with the flow arrow on the upstream side, with the arrow head pointing in the direction of flow. Position a gasket in place for each side. Make sure both gaskets are smooth and even with no gasket material extending into the flow profile. Obstructions in the pipeline will disturb the flow and cause inaccurate measurements.
3. Install bolts in both process connections. Tighten the nuts in the sequence shown in the image below. Check for leaks after tightening the flange bolts. The required bolt load for sealing the gasket joint is affected by several application-dependent factors, therefore the required torque for each application may be different. Refer to the ASME Pressure Vessel Code guidelines for bolt tightening standards.

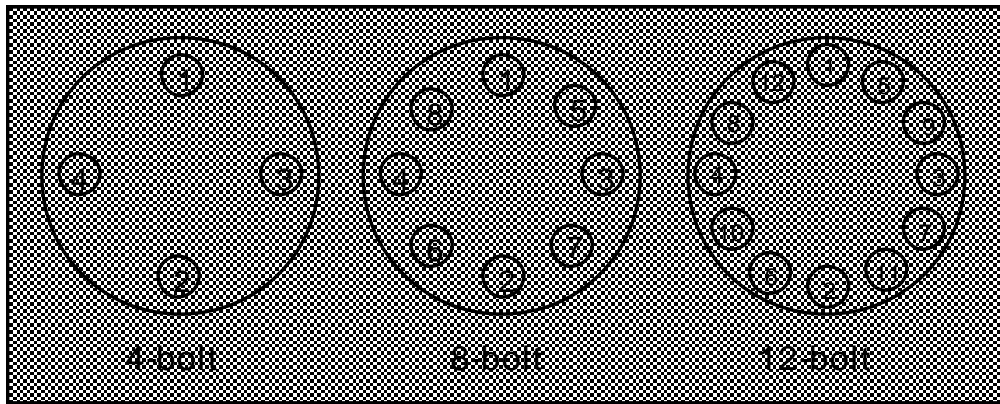

241i Insertion Flow Meter Installation

Prepare the pipeline for installation using either a cold tap or hot tap method described on the following pages. Refer to a standard code for all pipe tapping operations. The following tapping instructions are general in nature and intended for guideline purposes only. Before installing the meter, review the mounting position and isolation valve requirements given below.

Mounting Position

Allow clearance between the electronics enclosure top and any other obstruction when the meter is fully retracted.

Isolation Valve Selection

An isolation valve may be used with 241i meters. It must meet the following requirements:

1. A minimum valve bore diameter of 1.875 inches is required, and the valve's body size should be two inches. Normally, gate valves are used.
2. Verify that the valve's body and flange rating are within the flow meter's maximum operating pressure and temperature.
3. Choose an isolation valve with at least two inches existing between the flange face and

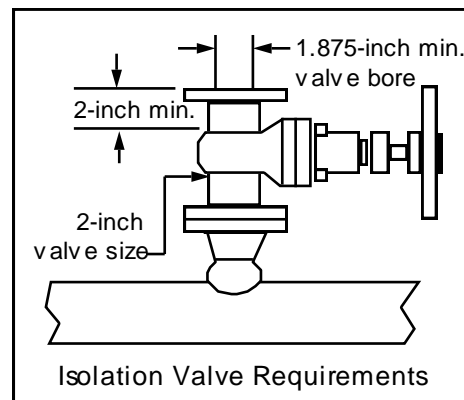

the gate portion of the valve. This ensures that the flow meter's sensor head will not interfere with the operation of the isolation valve.



When using toxic or corrosive gases, purge the line with inert gas for a minimum of four hours at full gas flow before installing the flow meter.

Cold Tap Guidelines

Refer to a standard code for all pipe tapping operations. The following tapping instructions are general in nature and intended for guideline purposes only.

1. Turn off the flow of process gas, liquid or steam. Verify that the line is not pressurized.
2. Confirm that the installation site meets the minimum upstream and downstream pipe diameter requirements. See Figure 1, page 14.
3. Use a cutting torch or sharp cutting tool to tap into the pipe. The pipe opening must be at least 1.875 inches in diameter. (Do not attempt to insert the sensor probe through a smaller hole.)
4. Remove all burrs from the tap. Rough edges may cause flow profile distortions that could affect flow meter accuracy. Also, obstructions could damage the sensor assembly when inserting into the pipe.
5. After cutting, measure the thickness of the cut-out and record this number for calculating the insertion depth.
6. Weld the flow meter pipe connection on the pipe. Make sure this connection is within $\pm 5^\circ$ perpendicular to the pipe centerline.
7. Install the isolation valve (if used).
8. When welding is complete and all fittings are installed, close the isolation valve or cap the line. Run a static pressure check on the welds. If pressure loss or leaks are detected, repair the joint and re-test.
9. Connect the meter to the pipe process connection.
10. Calculate the sensor probe insertion depth and insert the sensor probe into the pipe as described on the following pages.

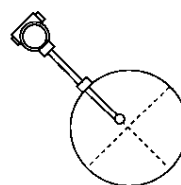

Correct Alignment

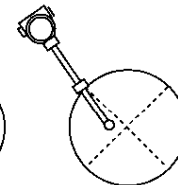



Incorrect Alignment



All flow meter connections, isolation valves and fittings for cold tapping must have the same or higher pressure and temperature rating as the main pipeline.

Hot Tap Guidelines

	Hot tapping must be performed by a trained professional. U.S. regulations often require a hot tap permit. The manufacturer of the hot tap equipment and/or the contractor performing the hot tap is responsible for providing proof of such a permit.
---	---

	All flow meter connections, isolation valves, and fittings for hot tapping must have the same or higher pressure and temperature rating as the main pipeline.
---	---

Refer to a standard code for all pipe tapping operations. The following tapping instructions are general in nature and intended for guideline purposes only.

1. Confirm that the installation site meets the minimum upstream and downstream pipe diameter requirements.
2. Weld a two inch-inch mounting adapter on the pipe. Make sure the mounting adapter is within $\pm 5^\circ$ perpendicular to the pipe centerline (See previous page under “Isolation Valve Selection”). The pipe opening must be at least 1.875 inches in diameter.
3. Connect a two inch process connection on the mounting adapter.
4. Connect an isolation valve on the process connection. The valve’s full open bore must be at least 1.875 inches in diameter.
5. Run a static pressure check on the welds. If pressure loss or leaks are detected, repair the joint and re-test.
6. Connect the hot tapping equipment to the isolation valve, open the isolation valve and drill at least a 1.875 inch diameter hole.
7. Retract the drill, close the isolation valve, and remove the hot tapping equipment.
8. Connect the flow meter to the isolation valve and open the isolation valve.
9. Calculate the sensor probe insertion depth and insert the sensor probe into the pipe as described pages 17-19.

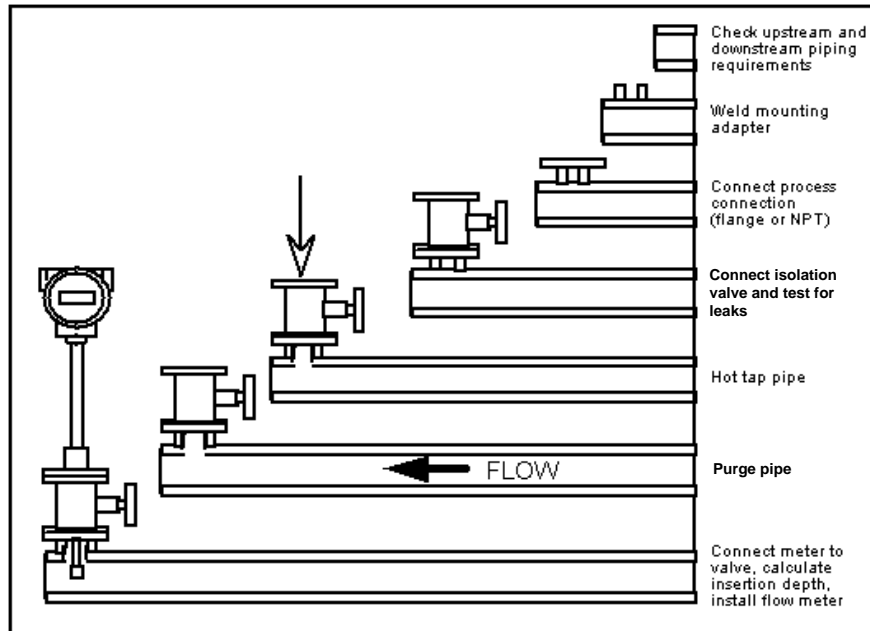

Figure 4. Hot Tap Sequence

Flow Meter Insertion

The sensor head must be properly positioned in the pipe. For this reason, it is important that insertion length calculations are carefully followed. A sensor probe inserted at the wrong depth in the pipe will result in inaccurate readings.

Insertion flow meters are applicable to pipes 2-inches and larger. For pipe sizes ten inches and smaller, the centerline of the meter's sensing head is located at the pipe's centerline. For pipe sizes larger than ten inches, the centerline of the sensing head is located in the pipe's cross section five inches from the inner wall of the pipe; i.e., its "wetted" depth from the wall to the centerline of the sensing head is five inches.

Standard Probe length, S, of the stem is 33.5 inches (850.9 mm).

Compact Probe length is 16.5 inches (419.1 mm).

Use the Correct Insertion Formula

Depending on your flow meter's process connection, use the applicable insertion length formula and installation procedure as follows:

- Flow meters with a compression type connection (NPT or flanged) follow the instructions beginning on page 19.
- Flow meters with a packing gland type connection (NPT or flanged) follow the instructions beginning on page 21.



An insertion tool must be used for any installation where a flow meter is inserted under pressure greater than 50 psig.

Installing Flow Meters with a Compression Connection

Use the following formula to determine insertion length for flow meters (NPT and flanged) with a compression process connection. The installation procedure is given on the next page.

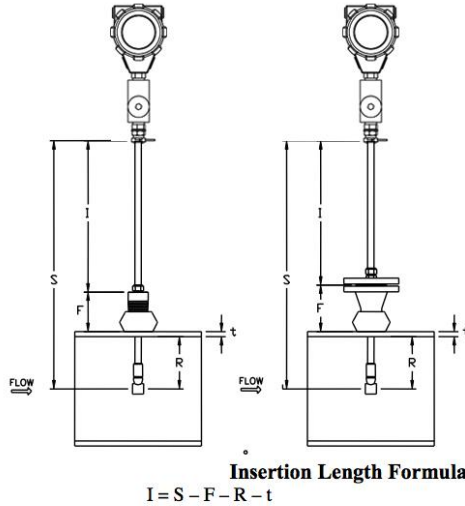

Where:

I = Insertion length.

S = Stem length – the distance from the center of the sensor head to the base of the enclosure adapter (S = 33.5 inches for standard probes; S = 16.5 inches for compact).

F = Distance from the raised face of the flange or top of NPT stem housing to the outside of the pipe wall.

R = Pipe inside diameter + 2 for pipes ten inches and smaller.

R = Five inches for pipe diameters larger than ten inches.

t = Thickness of the pipe wall. (Measure the disk cut-out from the tapping procedure or check a piping handbook for thickness.)

Figure 5. Insertion Calculation (Compression Type)

Example:

To install a 241i meter with a standard probe (S = 33.5 inches) into a 14-inch schedule 40 pipe, the following measurements are taken:

F=3 inches

R=5 inches

t=0.438 inches

The insertion length for this example is 25.06 inches. Insert the stem through the fitting until an insertion length of 25.06 inches is measured with a ruler.

Insertion Procedure for Meters with a Compression Connection

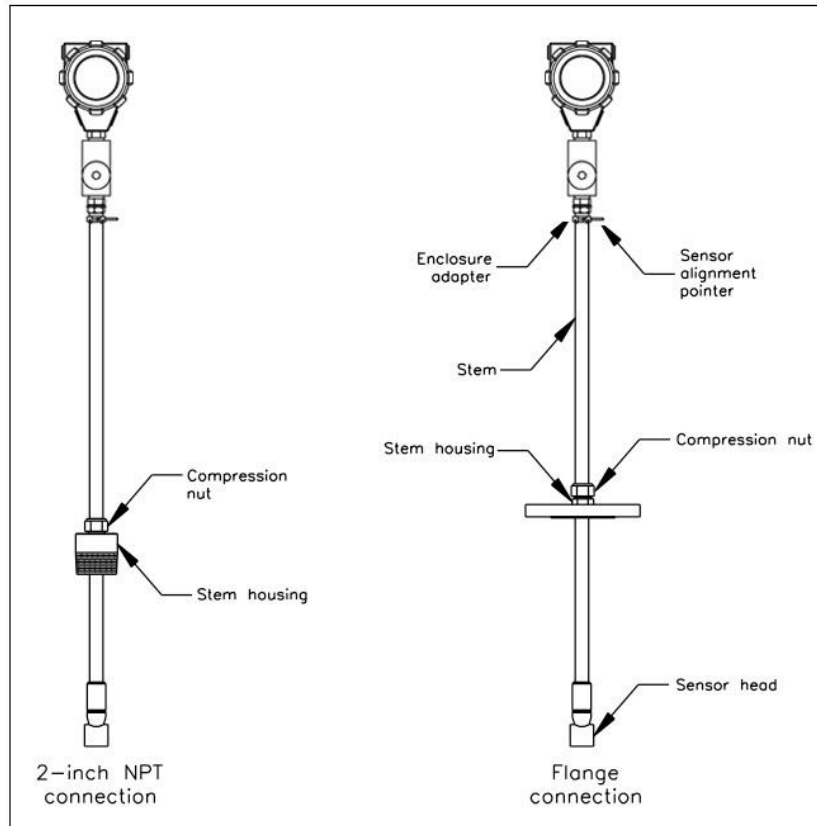

Figure 6. Insertion Flow Meter with Compression Type Fitting



The sensor alignment pointer must point downstream, in the direction of flow.



To avoid serious injury, DO NOT loosen the compression fitting under pressure.

1. Calculate the required sensor probe insertion length.
2. Fully retract the stem until the sensor head is touching the bottom of the stem housing. Slightly tighten the compression nut to prevent slippage.
3. Bolt or screw the flow meter assembly into the process connection. Use Teflon tape or pipe sealant to improve the seal and prevent seizing on NPT styles.
4. Hold the meter securely while loosening the compression fitting. Insert the sensor into the pipe until the calculated insertion length, I , is measured between the base of the enclosure adapter and the top of the stem housing, or to the raised face of the flanged version. Do not force the stem into the pipe.

5. Align the sensor head using the sensor alignment pointer. Adjust the alignment pointer parallel to the pipe and pointing downstream.
6. Tighten the compression fitting to lock the stem in position. **When the compression fitting is tightened, the position is permanent.**

Installation of Meters with Packing Gland Connection

Use the following formula to determine insertion depth for meters with a packing gland connection (NPT and flanged)

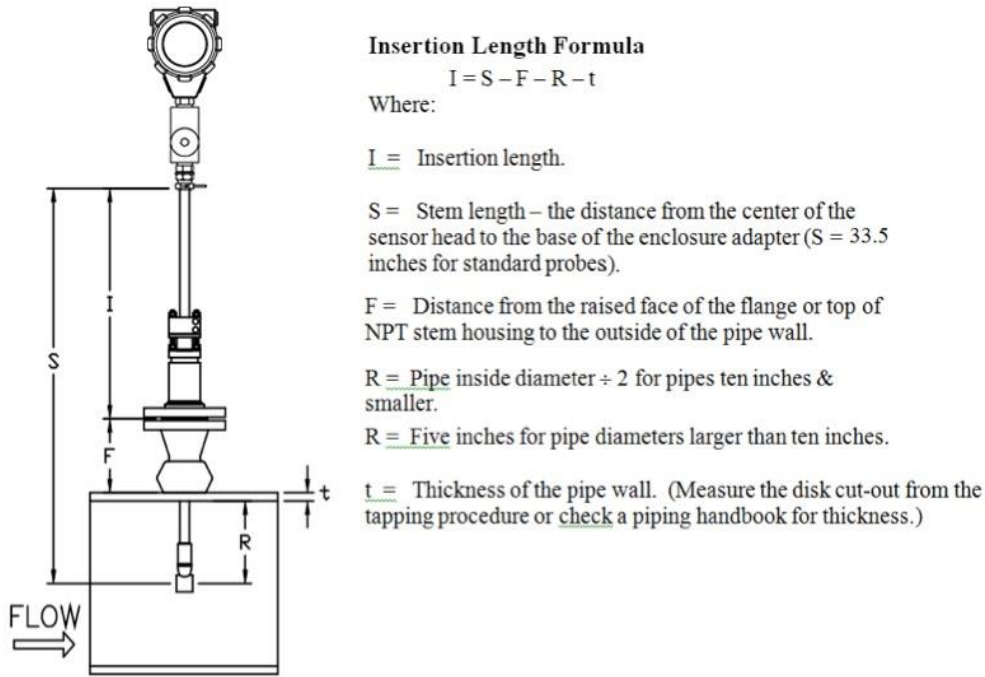

Figure 7. Insertion Calculation

Example:

To install a 241i Flow Meter with a standard probe ($S = 33.5$) into a 14-inch schedule 40 pipe, the following measurements are taken:

$$\begin{aligned} F &= 3 \text{ inches} \\ R &= 5 \text{ inches} \\ t &= 0.438 \text{ inches} \end{aligned}$$

The example insertion length is 25.06 inches.

Insertion Procedure for Flow Meters (Packing Gland Connection)

	The line pressure must be less than 50 psig for installation.
---	---

	The sensor alignment pointer must point downstream, in the direction of the flow.
---	---

1. Calculate the required sensor probe insertion length.
2. Fully retract the stem until the sensor head is touching the bottom of the stem housing. Remove the two top stem clamp nuts and loosen two stem clamp bolts. Slide the stem clamp away to expose the packing gland nuts. Loosen the two packing gland nuts.
3. Align the sensor head using the sensor alignment pointer. Adjust the alignment pointer parallel to the pipe and pointing downstream.
4. Insert the sensor head into the pipe until insertion length, I, is achieved. Do not force the stem into the pipe.
5. Tighten the packing gland nuts to stop leakage around the stem. Do not torque over 20 ft-lbs.
6. Slide the stem clamp back into position. Torque stem clamp bolts to 15 ft-lbs. Replace the stem clamp nuts and torque to 10-15 ft-lbs.

Wiring Connections-Protection of Your Meter

To protect your investment and be certain of a long reliable service life, we have compiled some guidelines (from experience) that will aid your installation team in properly protecting the electronics from the application environment. These instruments have been designed for and proven reliable in some of the most extreme process conditions in industry: Mining, Oil and Gas, Water, Wastewater etc. The key however is to follow best practices to insure a proper seal to protect the internal components of this precision instrument.

	Failure to adhere to these guidelines may result in water damage that is not covered under Sierra's Warranty Policy .
---	---

Water penetration can lead to a damaged flow meter. Sierra's "E" HALE ex-proof enclosures are rated to a NEMA4X, IP66 rating. This provides protection against, rain, sleet, snow and splashing water, but water can damage the sensor, electronics or wiring terminals if the meter is not properly installed and maintained.

To minimize the potential for water damage, Sierra Instruments recommends the following:

- Install conduit seals near the enclosures on all ports.
- Use a cable gland design that provides shielded cable termination and an environmental seal against dirt and water.
- Do not bend, kink, or otherwise distort the cable at the entry points to the cable glands.
- Route conduit or cable using a drip loop or drain as close as possible to the enclosure ports unless the cable slopes directly down.
- If the factory cable glands are replaced to install other adapter fittings, conduit fittings, cable glands, or any other modification to the cable entry points be sure to use a good quality thread sealant on all NPT threads as well as verifying they are all tightened and sealed appropriately so as not to leak.
- Be certain to use NPT threads when connecting to the housing. Some electrical fittings are not tapered but will fit in the NPT ports of the enclosure. Sufficient Teflon tape and pipe dope is recommended to insure a leak tight seal.
- If you are uncertain of the conditions the interior of the housing is subjected to over time, a small temporary datalogger can be placed in the housing to record temperature and humidity to establish a baseline. Corrective action can be made based on this data before instrument degradation sets in. Contact Sierra Instruments for suggested sources of small dataloggers.
- Keep the enclosure lids sealed tight using the supplied o-rings.
- As part of the lid o-ring inspections look for any signs of condensation inside of the enclosure. If condensation or signs of condensation/corrosion are found be sure all fittings/seals are securely tightened as well as a desiccant bag can be used and replaced as needed. This can be particularly important if the temperature is cycled.

Specific Wiring Related Requirements for Agency Approved cFMus and ATEX/IECEX Certified Units

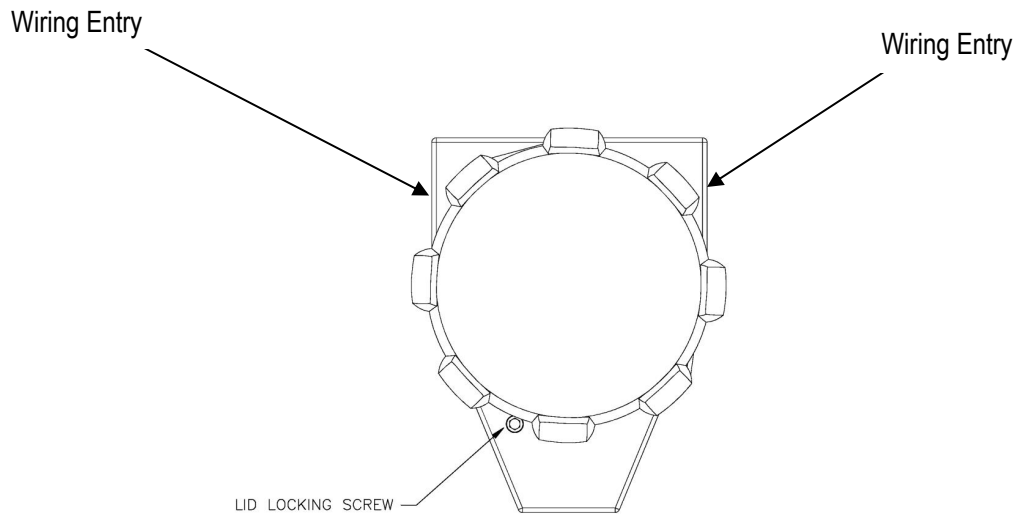

Figure 8. InnovaMass 240i and 241i Main and Remote Enclosure Shown with wiring entries

Shown above, the input power and signal wiring entry threads on the enclosures are $\frac{3}{4}$ inch -14 female NPT threads according to the NPT requirements of ANSI B1.20.1 plus +0.5 to +2.0 turns deeper.

- Unused entries are to be sealed with suitably certified plugs.
- Field wiring should be rated 80°C (176°F) or above.
- Flameproof/explosion proof joints should not be repaired, contact Sierra Instruments in the event that repair of the joints is necessary.

General Terminal Board Layout

Use the terminal blocks located inside the cap of the flow meter enclosure for all wiring connections. Make sure to observe all CE compliance requirements for AC wiring connections given on page 23. Note 4-20 mA outputs are configurable. Typically this will be flow, temperature and pressure, as illustrated with Figure 9. All wiring procedures must be performed with the power off and following good ESD practices.

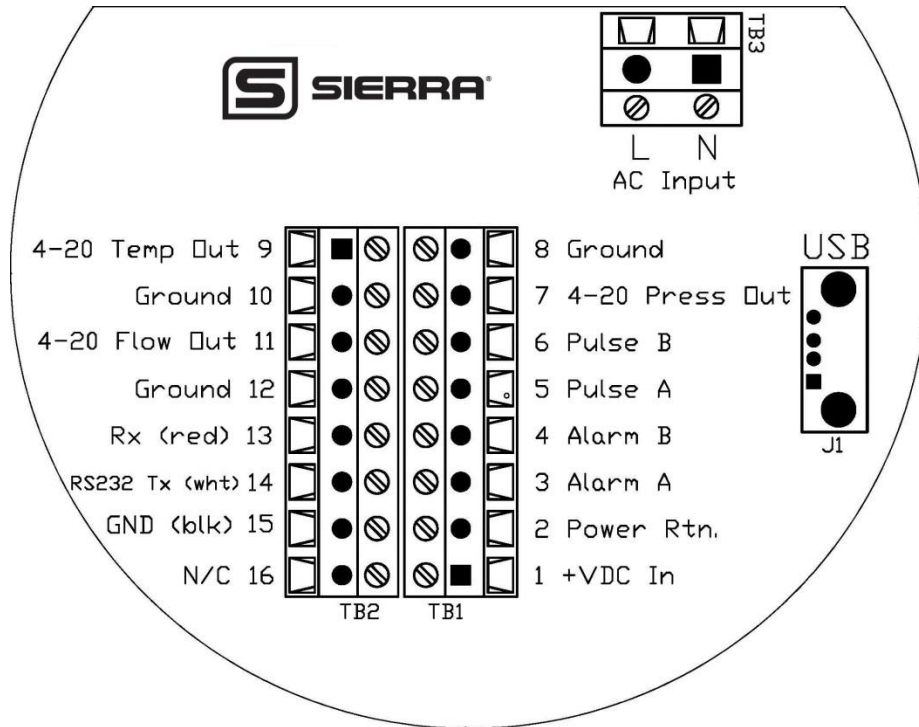

Figure 9. Wiring Access

	To avoid potential electric shock, follow National Electric Code safety practices or your local code when wiring this unit to a power source and to peripheral devices. Failure to do so could result in injury or death. All AC power connections must be in accordance with published CE directives.
--	--

Particular Recommendations: Lid Locking

	Safety is guaranteed as long as the covers are correctly screwed and locked.
--	--

The lid locking screws are #10-24 Socket Head Cap Screws (SHC Screw) that use a 5/32-inch hex head wrench/driver to adjust (See Figure 10, page 24). To lock the lids, firmly tighten down/secure the lid and then back out the associated SHC screw firmly so that the lid is secured and locked in place.

If one of the ribs/bumps on the lid happens to line up so it is blocking access to the SHC screw, then either slightly tighten the lid or loosen the lid slightly, just enough to gain access to the lid locking SHC screw.

	Note: that this very minor adjustment, if necessary, does not affect the leak integrity of the enclosure.
--	---

To un-lock the lid allowing for removal, just turn in the associated SHC screw so that it is no longer in contact with the lid; then the lid can be removed. There are two lids to be locked on the

main enclosure and two lids to be locked on the remote enclosure (if E4 feature was ordered) enclosures in order to maintain the safety ratings.

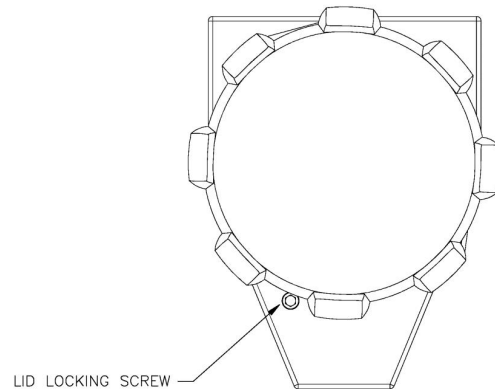



Figure 10. InnovaMass Main and Remote Enclosure Shown With Lid Locking Screw

The following warnings should be obeyed:

	<ul style="list-style-type: none">• DO NOT OPEN WHEN AN EXPLOSIVE ATMOSPHERE IS PRESENT• DO NOT OPEN WHEN ENERGIZED• POTENTIAL ELECTROSTATIC CHARGING HAZARD—SEE INSTRUCTIONS
--	--

To minimize an electrostatic charging hazard on the exterior of the enclosures both the main and remote (if E4 option ordered) enclosures should be connected to earth ground, see below for more details.

1. **Earthing:** The Sierra Instruments units must be connected to a good quality earth. The units are provided with internal and external earthing terminals.
2. **External Earthing:** The external earthing connections are located on the boss on the outside of both the main housing and remote housing (E4 option if ordered) and consist of an 18-8SS pan head Phillips screw (10-24 UNC-2B thread) and a serrated tooth #10 ring terminal for 16-14 AWG wire.
3. **Internal Earthing:** The internal earthing connection is located in the main and remote (E4 option if ordered) housing terminal side and consist of an 18-8SS pan head Phillips screw (10-24 UNC-2B thread) and a serrated tooth #10 ring terminal for 16-14 AWG wire.

Input Power Wiring

AC Power Wiring

The AC power wire size must be 26 to 16 AWG with the wire stripped 1/4 inch (6 mm). Connect 100 to 240 VAC (0.2 Amps RMS at 230 VAC) to the neutral and line terminals on the terminal block. Connect the ground wire to the safety ground lug. Torque all connections to 4.43 to 5.31 in-lbs (0.5 to 0.6 Nm).

The Hazardous-Area enclosure has two separate conduit entries to maintain separation between AC input power and output signal wiring. To eliminate the possibility of noise interference, use a separate cable entry for the AC power and signal lines. See Figure 11.

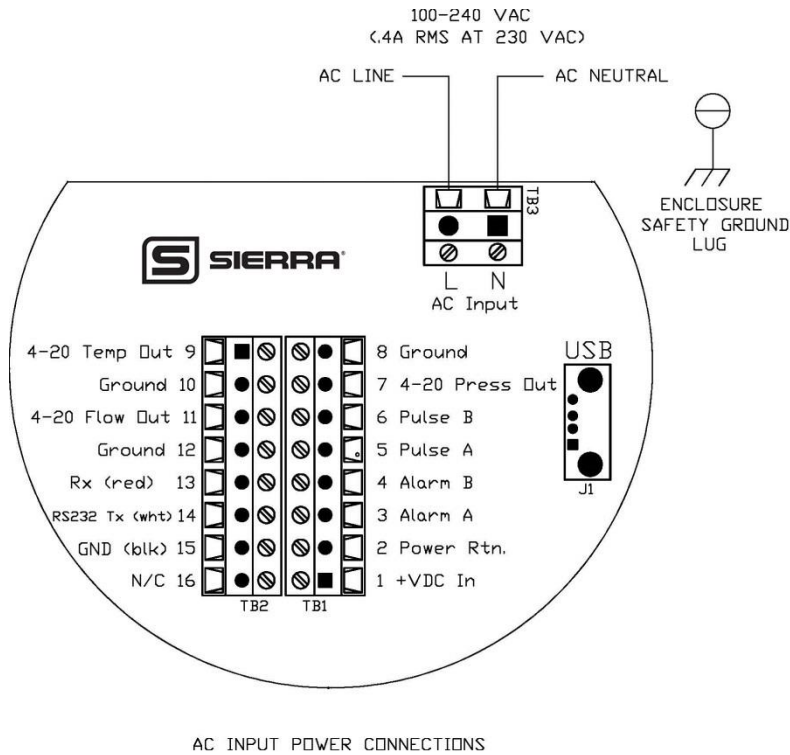

Figure 11: AC Input Power Connections



All wiring procedures must be performed with the power Off.



The AC wire insulation temperature rating must meet or exceed 80 °C (176°F).

DC Power Wiring

The DC power wire size must be 26 to 16 AWG with the wire stripped 1/4 inch (6 mm). Connect 24 VDC +/- 10% (0.4 amp load, maximum) to the terminals marked on the terminal block. Connect the earth ground wire to the safety ground lug. Torque all connections to 4.43 to 5.31 in-lbs (0.5 to 0.6 Nm).

If conduit seals are used, they must be installed within 18 inches of the enclosure. See Figure 12.

	<p>All wiring procedures must be performed with the power off.</p>
---	--

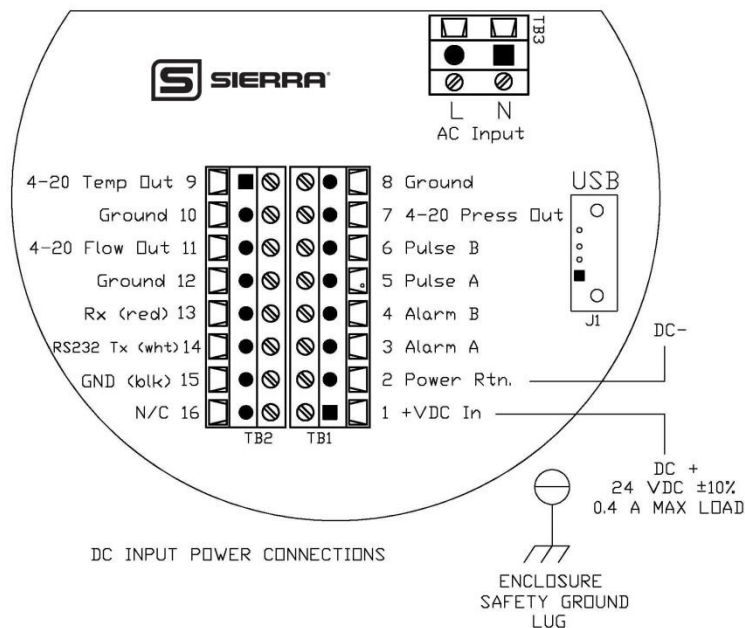

Figure 12: DC Input Power Connections

Output Signal Wiring

You must use metal cable glands that provide cable screen clamping. The cable screen should be connected to the gland and shielded at both ends over 360 degrees. The shield should be terminated to an earth ground.

For all installations not using metal conduit, two ferrite beads should be added, one on each end of the I/O cable. This is to maintain CE related EMI/RFI protection. Good quality (highest impedance at 100MHz) broadband ferrites should be used; a solid cylindrical ferrite (recommended) usually has better performance than a clamp on ferrite. The ferrites should fit as tight as possible to the OD of your cable. See Figure 14.

4-20 mA Output Wiring

All InnovaMass 240i/241i Series flow meters are equipped with calibrated 4-20 mA output signals for flow, temperature, and pressure.

The 4-20 mA current loop output is non-isolated. Max load 500 ohms.

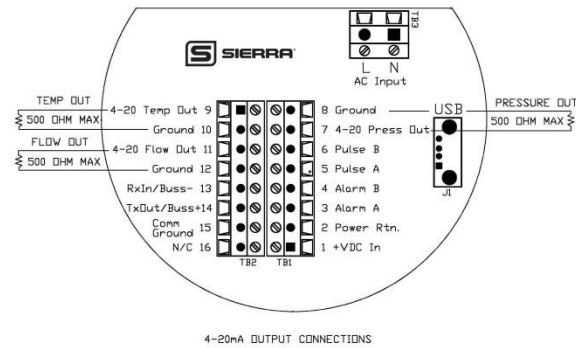

Figure 13. 4-20mA Output Connections

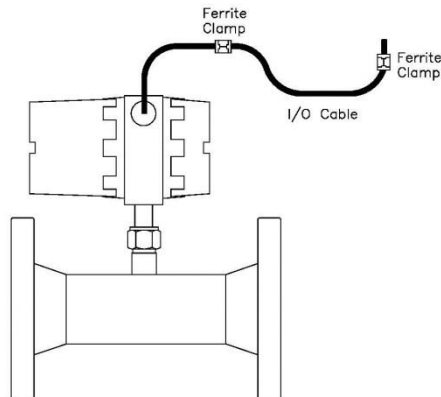

Figure 14. Ferrite Installation (Ferrite not required for conduit)



Do not externally power the 4-20mA output loop. It is a self-powered loop.

Alarm Output Wiring

One alarm output contact is included on the flow meter terminal block. The alarm output is driven by an optical relay that is normally-open single-pole. The relay is isolated and requires a separate power supply (isolated). The voltage of the alarm output is the same as the voltage supplied to the circuit.

To use an external power supply for an isolated alarm output, connect as shown in Figure 15. You may set low, high or window alarms for temperature, pressure, totalizer, mass flow or volumetric flow.

FIGURE 2-9
ISOLATED ALARM OUTPUT

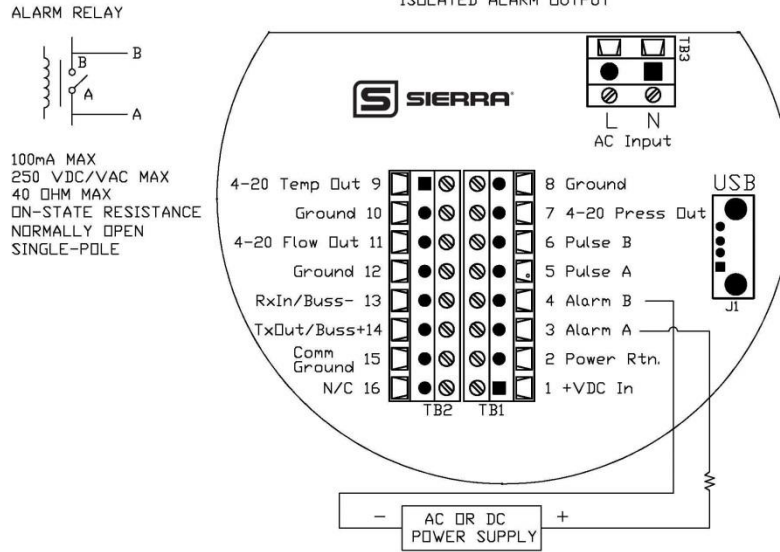

Figure 15. AC or DC Power Supply

RS-232 Wiring

RS-232 provides serial communication. For RS-232, wire per Figure 16.

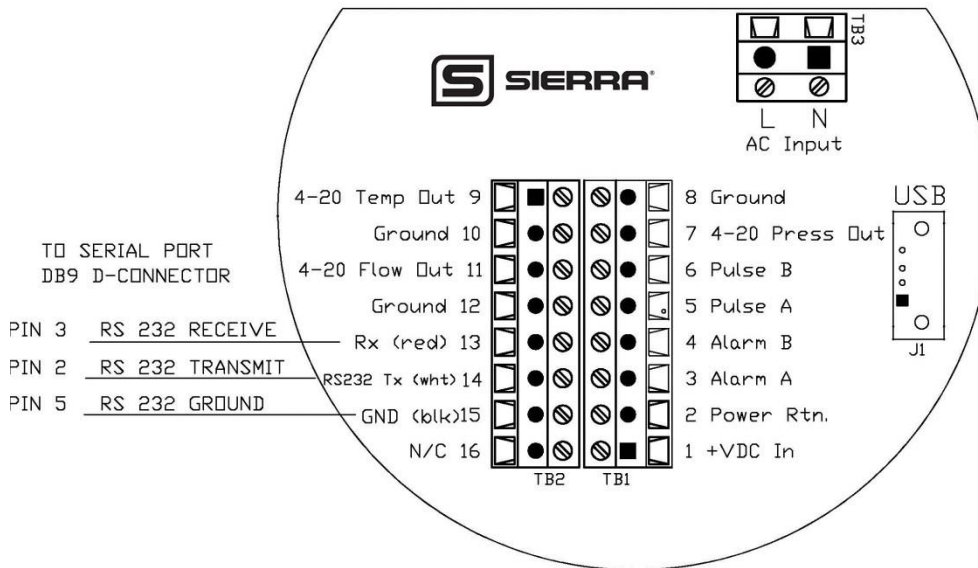

Figure 16. RS-232 Communication

Pulse Output

InnovaMass provides an adjustable pulse output with a maximum of 1 Hz. Wire pulse output per Figure 17.

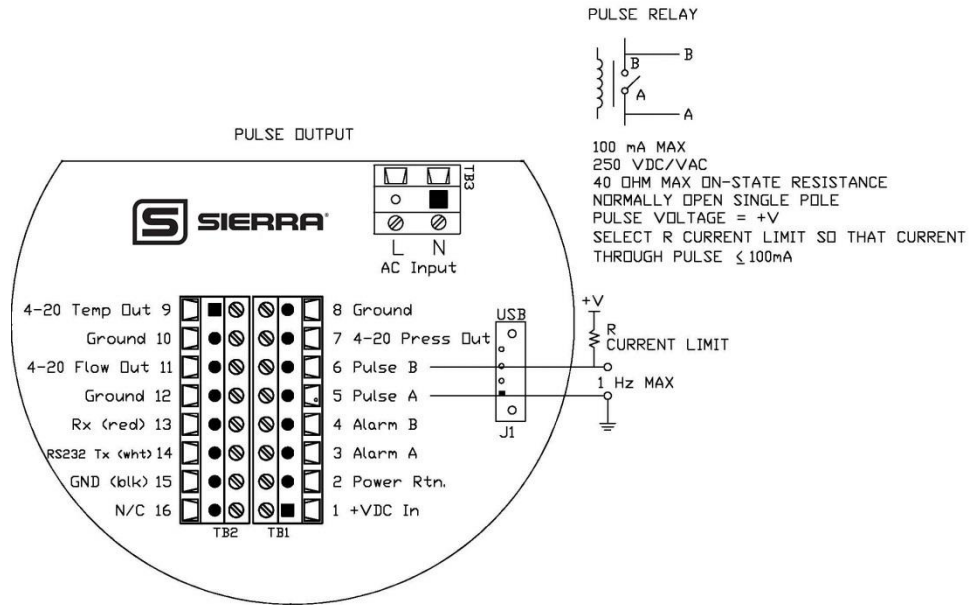

Figure 17. Pulse Output

USB Output

This USB plug (J1) is used to connect to the SIP Software, per Figure 18.

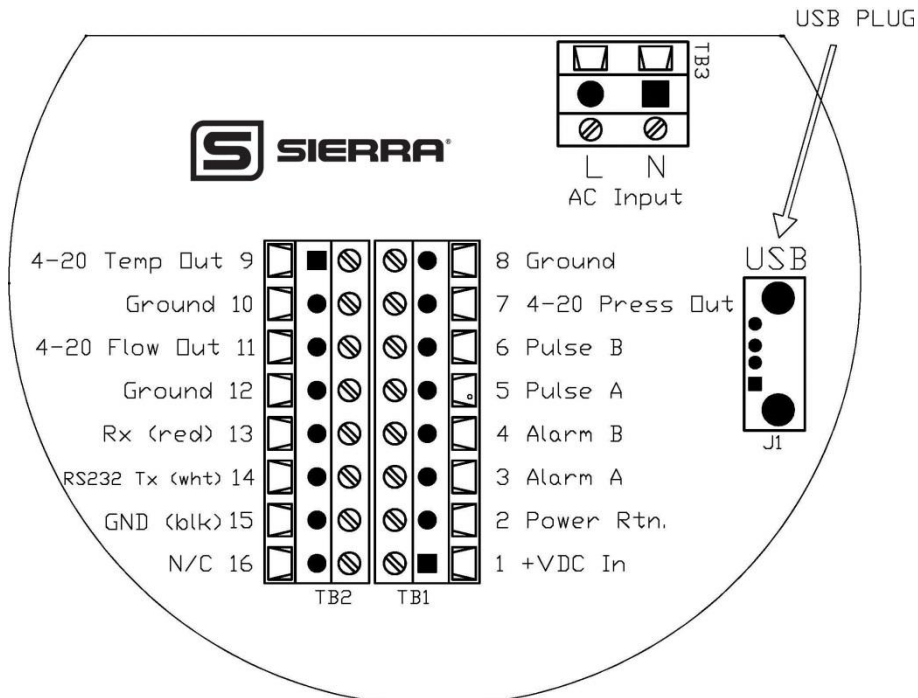

Figure 18. USB Output

Remote Sensor Wiring

When connecting the sensor probe to a remotely mounted flow meter enclosure, use only factory supplied cables. When connecting more than one meter, do not intermix the sensor probes and electronics.

The electronics, sensor probes and interconnecting cables supplied by Sierra Instruments are calibrated as a complete precision mass flow circuit. To make wiring connections from a sensor probe junction box to a remotely mounted enclosure, see Figure 19.

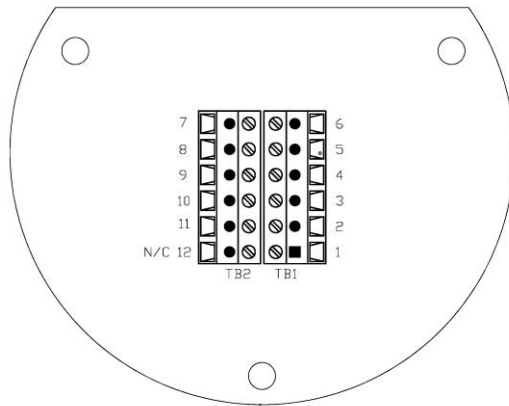

Figure 19: Remote Junction Box

Terminal Block Number	Remote Cable Wire Color
1	*Orange
2	*White/Black
3	*Red/Black
4	*Orange/Black
5	White
6	Black
7	**Blue/Black
8	**Blue
9	**Green
10	**Green/Black
11	Red
12	N/C

Note: *These wires are only present if the pressure option was ordered.

** These wires are only present if the temperature option was ordered.

Chapter 3: Local Display/Interface Operation & Programming

General Navigation

In general terms, the menu system consists of a main menu, the set-up menu, a sub-menu to program each item in the set-up menu, and a series of data entry or pull-down screens to enter set-up data for each parameter.



Watch Video Tutorial – video tutorials for the local display interface as well as the Smart Interface Portal (SIP) software is available on the USB flash drive provided in the product shipment.

Menus may be adjusted using the six buttons on the front of the unit: up ▲, down ▼, left ◀, right ▶, enter ↵ and escape/cancel ⊗, or by using the Smart Interface Portal (SIP) software provided free with the instrument.

Pressing the left ◀ button will move the menu selection to the left or the data entry field to the left if updating a menu value.

Pressing the right ▶ button will move the menu selection to the right or the data entry field to the right if updating a menu value.

Pressing the up ▲ button will move the menu selection up, or increment the data entry field if you're updating a menu value.

For example, if you're updating a value, and that value is currently set to "0", pressing the up ▲ key will increase the value to the next logical value; in our example, it would be "1", then "2", "3" and so on to "9" then back to "0."

Pressing the down ▼ button will move the menu selection down or decrement the data entry field if you're updating a menu value.

For example, if you're updating a value, and that value is currently set to "9", pressing the down ▼ key will decrease the value to the next logical value; in our example, it would be "8", then "7", "6" and so on to "0" then back to "9."

Pressing the enter ↵ key accepts the current value.

Pressing the escape/cancel ⊗ key returns to the last previous menu, and if you're currently editing a value, will cancel any changes you've made.



The screen data "flashes" to show that you are actively editing. Pressing the enter key permanently writes the data to the meters memory.

Summary of Menus/Tables

1. Main Menu: Displays Measured Variables and Initial Setup (page 34)
2. Sub Menus: Set-up, Calibration, and Diagnostics menus (page 36)
3. Calibration: Set-up Dial-A-Fluid and Dial-A-Pipe (page 36)
4. Diagnostics: Meter status and Troubleshooting (page 45)
5. Meter Status: Gives Error Codes (page 46)
6. Low/High: Shows low/high process values (page 53)
7. Sensor Tune: Tune to a specific application (page 55)
8. Fluid Properties: Simulate Temp, Pressure, Density and Viscosity (page 61)
9. Process T and P: Adjust T&P Units and simulate T, P (page 63)
10. Totalizer: Set-up Totalizer (page 66)
11. Alarms: Select Alarm Types (page 70)
12. Flow Alarms: Set Low and High Alarms (page 71)
13. Outputs: Set-up and Test All Analog Outputs (page 74)
14. Reference Conditions: Set Normal or Standard (page 78)

Start-up Routine

When the meter is first powered up, it will cycle through set-up data. See an example below of the type of screens you will see. A “!” then * will flash as the meter boots up, then disappear.



If “!” remains, the meter has encountered a fault. Refer to the “Diagnostic sub-menu” then “Meter Status” for details.

1. Product name and firmware version. Left is main PCA / right is display PCA

240i/241i
V1.0.X/V1.0.X

2. Serial Number

Serial
1234XXXX

3. Full Scale

Full Scale
100.00 SCFM

4. Fluid

Dial-A-Fluid
Carbon Dioxide

5. Pipe ID

Dial-A-Pipe ID
1234XXXX/ In

6. Tag Number

Tag 1234XXXX

	All of these values are also displayed on the provided SIP (Smart Interface Portal) software.
---	---

Level 1: Main Menu

Once set-up data is displayed, the meter will display the flow variables. The instrument will Auto Scroll through the Flow/Temp, Pressure, Density, And Totalizer (if turned on), Active Alarms (if any), and the remaining variables of Table 1, then return to repeat screens. See Table 1.

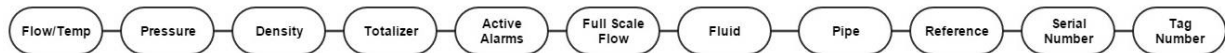



Table 1: Main Menu Level 1

You can turn “Off” the auto scroll feature by hitting the ▼ down arrow.

Auto Scroll Off

Turn Auto Scroll back “On” again by hitting the ▲ up arrow. Auto Scroll will default back to on if power is cycled.

Auto Scroll On

	You may scroll through the remaining screens manually. By entering ↵, you will see the password screen. You can also go back using ⓧ at any time or exit to the main screen by pressing ⊗.
---	--

Main Menu Example:

1. Flow and Temperature

0.11 SCFM 97.66 F

2. Pressure

Pressure
0.00/psia

3. Density

Density lb/ft³
62.4

4. Totalizer

You can always scroll to the totalizer screen manually, but it will only auto scroll if turned on. See note above.

Total Units SCF
0.00

5. Alarm

Active Alarm
Flow – L (On)

6. Full Scale Flow

Full Scale Flow
100.00 SCFM

7. Dial-A-Fluid (Gas, Liquid or Steam Type)

Dial-A-Fluid
Carbon Dioxide

8. Dial-A-Pipe

Dial-A-Pipe
ID

9. Reference Conditions

Ref: Standard
14.695949 / 70.0

10. Serial

Serial
1234XXXX

11. Tag

Tag
1234XXXX

And finally complete the cycle back to the flow and temperature screen.

Level 2: Sub-Menu (Password Protected)

At this point, you can access various other menus. To enter the next level, press the enter key. You will be requested to enter a password. Default is 0000 and can be reset in a later screen or using SIP:

Password
0000

Use the up ▲ and down ▼ buttons to cycle through numbers and left ◀ and right ▶ buttons to move to the next digit. Once the correct password has been entered, hit enter ↵ to get to the Level 2 Sub-Menu shown in Table 2.

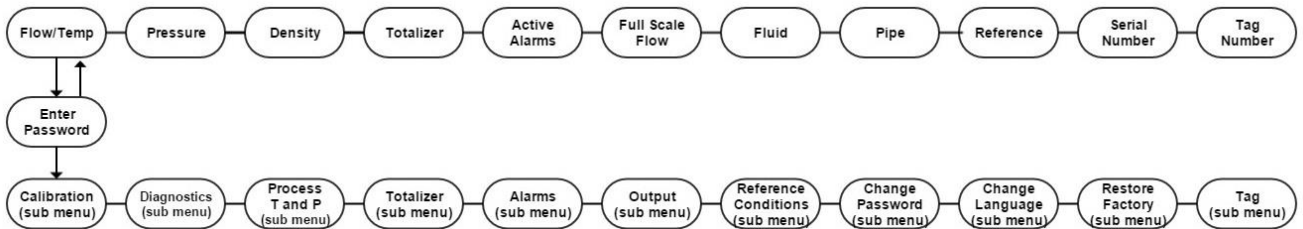

Table 2: Level 2 Sub-Menu

Calibration (Sub-Menu)

The calibration menu allows you to set up the meter to match the application. See Table 3 below for guidance.

Calibration
(Sub-Menu)

To start, move down to the next level by pressing the enter key ↵. From this level, you can set up Dial-A-Fluid and Dial-A-Pipe.

In addition you can adjust span, min noise, Ck, %FS cut off, output averaging and view the calibration K-Factor and date.



Note that you can also use the function selector of the Smart Interface Portal (SIP) provided free with the meter.

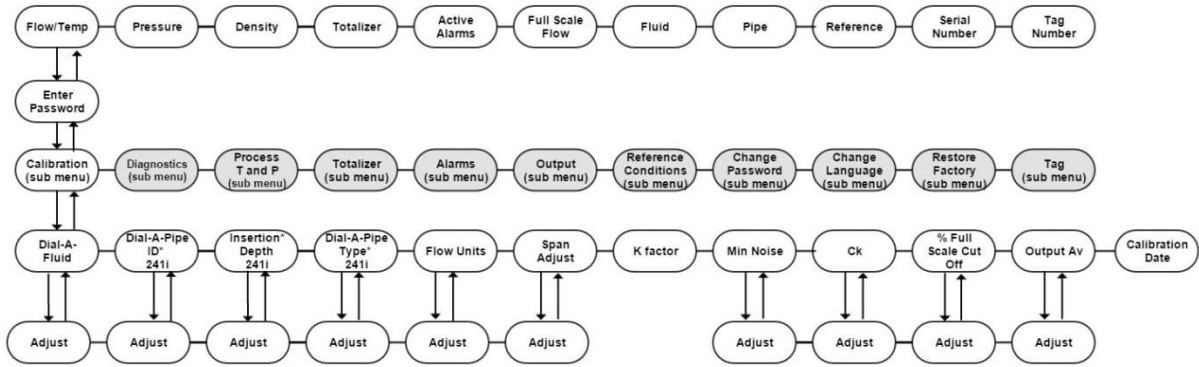

*241i Insertion Only

Table 3: Calibration Sub-Menu



These screens, **Dial-A-Pipe ID**, **Insertion Depth**, **Dial-A-Pipe Type** are available only with the insertion version InnovaMass 241i.

Calibration (Sub-Menu): Gas Type – Dial-A Fluid

Use the “Dial-A-Fluid” sub-menu to change and select the fluid to be measured. Our Dial-A-Fluid feature is a powerful and unique feature of the 240i/241i. You are able to change your fluid in the field between air, water, steam, other liquids or other gases (other liquids, other gases not operational yet).

The display will show fluid type and list the currently selected fluid.

Dial-A-Fluid
Carbon Dioxide

Once on the “Dial-A-Fluid” screen, press enter key . Press again until the current selected fluid begins to flash. It may take a few seconds to begin to flash.

Use the up and down keys to select between fluid options then hit enter . The selection will stop flashing and be permanent.



More fluid choices may be available through Smart Interface Portal (SIP).

You can press the exit ⊗ several times to climb back up to the main menu level or press ► to proceed to the next Calibration Sub-Menu called Dial-A-Pipe ID.

Calibration (Sub-Menu): Dial-A-Pipe ID, Insertion Depth, Dial-A-Pipe Type

This instrument can be moved to different pipe sizes and types as needed and perform precision flow measurement. This capability is called Dial-A-Pipe and is a powerful and unique feature of the InnovaMass 241i immersible thermal mass flow meter.

The internal pipe diameter (ID), insertion depth, and pipe type are very important factors when considering flow profile. The 241i uses internal pipe diameter (ID), insertion depth, and the pipe type to mathematically model the flow profile and enable Dial-A-Pipe.

Adjustment can also be done using the SIP (Smart Interface Portal) Software. It is recommended to use the SIP to perform Dial-A-Pipe since the process is more automated.

The Dial-A-Pipe Process Requires 3 Steps:

Step 1: Setting Pipe Inner Diameter (ID)

Step 2: Setting Insertion Depth

Step 3: Setting Pipe Type

Dial-A-Pipe Step 1: Navigate to the “Dial-A-Pipe ID” screen. Use Table 3: Calibration Sub-Menu for guidance.

The display will show pipe inner diameter in the units selected. In the example below the inside diameter of the pipe is 6.065000 inches.

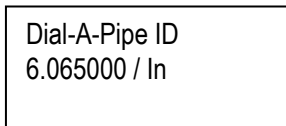

Press enter ↵ to cause the first digit (the 6 in 6.065000 in our example) to begin flashing. Use the up ▲ and down ▼ arrows to select the value 0 to 9. Once done, use the right key to move on to the selected significant digit. Once the I.D. value is selected, use the up ▲ and down ▼ keys to select the desired units.

I.D. Units:

in: inches

M: meters

mm: millimeters

ft: feet

It is vital to use the correct I.D. and units of the pipe where the instrument is located. If the schedule of the pipe is known, the I.D. can be looked up from pipe tables. If the pipe outer diameter and wall thickness is known, the I.D. can be calculated. If you do not have a round pipe, you must enter the equivalent round I.D. There are various methods of calculating this.

Here’s an easy calculation to give you the hydraulic diameter (H_D):

Hydraulic Diameter = H_D

$$H_D = \frac{4A}{P}$$





A = Cross sectional area of duct
P = Wetted perimeter of duct

Dial-A-Pipe Step 2: Navigate to the “Insertion Depth” screen. Use Table 3: Calibration Sub-Menu for guidance.

Pipe insertion depth is automatically set to the pipe centerline unless adjusted here. For some large pipes where centerline placement is not possible. An insertion depth of 5 inches is suggested.

The display will show probe insertion depth in the same units as the selected Dial-A-Pipe ID units in the step above. In the example below the insertion depth of the probe is 2.013000.

Insertion Depth
2.013000



Press enter  to cause the first digit (the 2 in 2.013000 in our example) to begin flashing. Use the up  and down  arrows to select the value 0 to 9. Once done, use the right key to move on to the selected significant digit. Once the Insertion Depth value is selected, press enter  to accept this value.

It is vital to use the correct Insertion Depth of the probe where the instrument is located.

Dial-A-Pipe Step 3: Pipe roughness does matter. The friction losses of the gas moving through the pipe are a major factor in the instruments calculation of the flow profile. Navigate to the “Pipe Type” screen. Use Table 3: Calibration Sub-Menu for guidance.

Use this menu screen to complete entering Dial-A-Pipe data. The display will show pipe roughness and the “type” of pipe. See example below:



Dial-A-Pipe
ss-smooth

Press enter  and the type of pipe will begin flashing. Go to the next level down with the  button and select the proper pipe type.

Choices Available:

- ss-smooth
- ss-normal
- ss-rough
- cs-smooth
- cs-normal
- cs-rough
- c-fiber
- cast-iron
- concrete
- PVC
- Glass
- ss-UHP

Where:
ss = stainless steel
cs = carbon steel
c-fiber = carbon fiber
UHP = ultra-high purity (5 – 10 Ra finish)

Again, use the  up and  down keys to select. The current choice will flash until the enter key  is pressed. Once the selection is made, the Dial-A-Pipe feature is complete.

You can press the exit ⊗ several times to climb back up to the main menu level or press ► to proceed to the next Calibration Sub-Menu called Flow Units.

Calibration (Sub-Menu): Flow Units

Navigate to the “Flow Units” screen. Use Table 3: Calibration Sub-Menu for guidance if necessary. Use this menu to enter the units for mass velocity or flow. The display will show the previously selected flow units. For example:

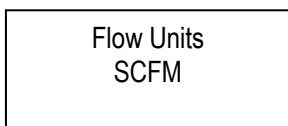

Press enter ↵ and the units will begin flashing. Use the up ▲ and down ▼ keys to select between the many flow units options then hit enter ↵. The selection will stop flashing and be permanent. The following table details the various flow units options available.

Calibration (Sub-Menu) “Flow Units” Available Choices	
Mass Flow Units	Description
SCFS, SCFM, SCFH, SCFD, SCFY	Standard Cubic Feet per Second, Minute, Day, Hour or Year. Standard conditions are set in the Reference Conditions menu.
MSCFS, MSCFM, MSCFH, MSCFD, MSCFY	Thousand Standard Cubic Feet per time unit. Standard conditions are set in the Reference Conditions menu.
MMSCFS, MMSCFM, MMSCFH, MMSCFD, MMSCFY	Million Standard Cubic Feet per time unit. Standard conditions are set in the Reference Conditions menu
NCFS, NCFM, NCFH, NCFD, NCFY	Normal Cubic Feet per time unit. Normal conditions are set in the Reference Conditions menu
SM3/sec; SM3/min; SM3/hr; SM3/day; SM3/yr	Standard Cubic Meters per unit time. Standard conditions are set in the Reference Conditions menu.
NM3/sec; NM3/min; NM3/hr; NM3/day; NM3/yr	Normal cubic meters per unit time. Normal conditions are set in the Reference Conditions menu.
SLPS, SLPM, SLPH, SLPD, SLPY	Standard Liters per unit time. Standard conditions are set in the Reference Conditions menu.
NLPS, NLPM, NLPH, NLPD, NLPY	Normal Liters per unit time. Normal conditions are set in the Reference Conditions menu.
Lbs/sec; Lbs/min; Lbs/hr; Lbs/day; Lbs/year	Pounds per unit time. Reference conditions NA
Ston/sec, Ston/min, Ston/hr, Ston/day, Ston/yr	Short Ton (2,000 lbs) per unit time. Reference conditions NA
Lton/sec, Lton/min, Lton/hr, Lton/day, Lton/yr	Long Ton (2,240 lbs) per unit time. Reference conditions NA
Mton/sec, Mton/min, Mton/hr, Mton/day, Mton/yr	Metric Ton 1000kg (2,204.6 lbs) per unit time. Reference conditions NA
Gram/sec; Gram/min; Gram/hr; Gram/day; Gram/yr	Grams per unit time. Reference conditions NA
Kg/sec; Kg/min; Kg/hr; Kg/day; Kg/yr	Kilograms per unit time. Reference conditions NA
SFPS, SFPM, SFPH, SFPD, SFPY	Standard Feet per Second, Minute, Day, Hour or Year. Standard conditions are set in the Reference Conditions menu. Note this is a point VELOCITY.
SMPS/M/H/D/Y	Standard Meters per Second, Minute, Day, Hour, or Year. Standard conditions are set in the Reference Conditions menu. Note this is a point VELOCITY.

NMPS, NMPM, NMPH, NMPD, NMPY	Normal Meters per Second, Minute, Day, Hour or Year. Normal conditions are set in the Reference Conditions menu. Note this is a point VELOCITY.
BTU	British Thermal Units per Second, Minute, Hour, Day, or Year. Reference conditions N/A.
KJoules	KJoules per Second, Minute, Hour, Day, Year. Reference conditions N/A.

Calibration (Sub-Menu) "Flow Units" Available Choices	
Volumetric Flow Units	Description
ACFS, ACFM, ACFH, ACFD, ACFY	Actual Cubic Feet per Second, Minute, Day, Hour or Year. No Reference Conditions are used.
AM3/sec, AM3/min, AM3/hr, AM3/day, AM3/yr	Actual Cubic Meters per Second, Minute, Day, Hour or Year. No Reference Conditions are used.
ALPS, ALPM, ALPH, ALPD, ALPY	Actual Liters per unit time. No Reference Conditions are used.
Gal/sec, Gal/min, Gal/hr, Gal/day, Gal/yr	US Gallons per unit time. No Reference Conditions are used.
MilG/sec, MilG/min, MilG/hr, MilG/day, MilG/yr	Million US Gallons per unit time. No Reference Conditions are used.
ImpG/sec, ImpG/min, ImpG/hr, ImpG/day, Imp /yr	Imperial Gallons per unit time. No Reference Conditions are used.
bbl/sec, bbl/min, bbl/hr, bbl/day, bbl /yr	Barrels per unit time. No Reference Conditions are used.
lit/sec, lit/min, lit/hr, lit/day, lit/yr	Liters per unit time. No Reference Conditions are used. Same as ALP* .
MilL/sec, MilL/min, MilL/hr, MilL/day, MilL/yr	Million Liters per unit time. No Reference Conditions are used.
m3/sec, m3/min, m3/hr, m3/day, m3/yr	Meter cubed per unit time. No Reference Conditions are used. Same as Actual Cubic meters (AM3*).
ft3/sec, ft3/min, ft3/hr, ft3/day, ft3/yr	Feet cubed per Second, Minute, Day, Hour or Year. No Reference Conditions are used. Same as Actual Cubic Feet, (ACF*)
FPS, FPM, FPH, FPD, FPY	Feet per Second, Minute, Day, Hour or Year. No Reference Conditions are used. Note this is a point VELOCITY.
MPS, MPM, MPH, MPD, MPY	Meters per Second, Minute, Day, Hour or Year. No Reference Conditions are used. Note this is a point VELOCITY.
bl/sec, bl/min, bl/hr, bl/day, bl/yr	Beer barrels per Second, Minute, Day, Hour, or Year.
In/sec, In/min, In/hr, In/day, In/yr	Inches per Second, Minute, Hour, Day, or Year.





You can press the exit ⊗ several times to climb back up to the main menu level or press ► to proceed to the next Calibration Sub-Menu.



Calibration (Sub-Menu): Span Adjust

The Span Adjust multiplies the meter output by a fixed value, from 0.5000000 to 2.0000000. Displayed Span Adjust is for the currently selected gas. This is useful if the meter displays a known offset from another device or expectation (calculated flow rate for example), and you want to make the meters “match”.

For instance, assume your process uses a less accurate rotameter that reads 100 scfm, and the more accurate 240i or 241i that reads 95 scfm to align. Enter a span factor of $100/95 = 1.052632$. The meter will then multiply by this factor so that the meter output equals the rotameter output of 100 scfm. Default is 1.0000000.

MeterSpan 1.00000000

Press enter  and the units will begin flashing. As in previous examples, use the    buttons to enter the desired value, and the enter key  to save the value.

You can press the exit  several times to climb back up to the main menu level or press  to proceed to the next Calibration Sub-Menu called K factor.

Calibration (Sub-Menu): K-Factor

The K-Factor menu displays the current value for meter calibration K-Factor. The K-Factor value is determined during meter calibration based on Frequency and Flow Rate.

	This K-factor is the meter calibration factor and cannot be adjusted.
---	---

K-Factor 17.6

Press  to proceed to the next Calibration Sub-Menu called Min Noise.

Calibration (Sub-Menu): Min. Noise

Minimum Noise Level: The Minimum Noise Level menu displays a value used for noise cutoff at zero flow. Electrical or Vibrational Noise that the sensor detects from the surrounding application environment (e.g. 60 Hz from power lines) can result in flow output when there is no actual flow. The Min. Noise can be changed in the “Meter Tune” section. Press  to proceed to the next Calibration Sub-Menu called Vortex coefficient Ck.

Min. Noise 9.2

Calibration (Sub-Menu): Vortex Coefficient Ck

The Vortex Coefficient Ck menu displays the current value set for Ck. Ck is used in the placement of a Low Pass Noise Filter which helps to avoid false frequency readings. Ck is calculated based on Frequency, Amplitude, and Gain along with the Density of the fluid under flow. Ck can be changed in the “Meter Tune” section.

Ck 21.1

	Although Min. Noise level and Ck can be adjusted, Autoset or Returned to Factory defaults here, it is recommended this be done from the “Meter Tune” section or from SIP. See “Meter Tune” for more information.
---	--

Press  to proceed to the next Calibration Sub-Menu called % Full Scale Cut-Off. .

Calibration (Sub-Menu): % Full Scale Cut-off

The InnovaMass 240i and 241i are extremely sensitive flow instruments that can pick up low flows due to leak-by or vibration and lead to totalization errors.

The % Full Scale Cut-off value forces both the digital display and the analog output values to zero/4 mA at a percentage of full scale from 0 to 50% of the full scale value. This is useful because pipes can show flow when all valves are shut.

The display value is for the currently selected gas:

%Full Scale Cut-off 0.000000



Enter the desired low flow cut off as a percentage of the full scale flow. The full scale flow is calibrated at the factory and is found in the main menu. You can press the exit  several times to climb back up to the main menu. For example, if the (as found) full scale flow in the main menu is:

%Full Scale Cut-off 100.00 SCFM

And the meter consistently shows a flow of 2 to 3 scfm even with all valves closed (and you are sure there are no leaks). For example, the meter %Full Scale Cut-off is set just above to:

%Full Scale Cut-off 5.000000

This is +/- 5% of the full scale of 100 scfm. The analog output and the digital display should be 0.000000 for any flow below 5.000000 scfm. The default value for %Full Scale Cut-off is 0.000000.

Once the low flow cut off % has been entered, use the enter key  to save the value. You can several press the exit  to climb back up to the main menu level or press  to proceed to the Output Averaging sub menu.

	% Full Scale Cut-off can also be set in the Diagnostics menu.
---	---

Calibration (Sub-Menu): Output Averaging

The Output Averaging menu displays the number of seconds for which output is averaged. Output Averaging allows for smoothing of noisy flow over time.

The meter samples the flow every 1 second (1 Hz). This value is fixed. Output Averaging will compute a rolling average of each reading over the requested time span.

For example, if the value is set to 5, then the flow output will always be a running average of the last 5 seconds of flow.



Output Averaging 5



As the Output Averaging value increases, meter response time will also increase.



Output Averaging can also be set in the Diagnostics menu.





Once output averaging has been entered, use the enter key  to save the value. You can several press the exit  to climb back up to the main menu level or press  to proceed to the Calibration Date sub-menu.

Calibration (Sub-Menu): Calibration Date

The calibration date is a read-only field that shows when the meter was last factory-calibrated in MM/DD/YYYY format.

Calibration Date 08/13/2012

Sierra recommends recalibration as required by your metrology policy or when the meter validation routine found in the Smart Interface Portal software detects a problem.

You can press the exit  several times to climb back up to the main menu level or press  to proceed back to the first Calibration Sub-Menu: Dial-A-Fluid. That concludes the Calibration Sub-Menu. Use  to reach the diagnostics sub-menus. Use  to reach other sub-menus in the sub menus (See Table 2 – also shown below).

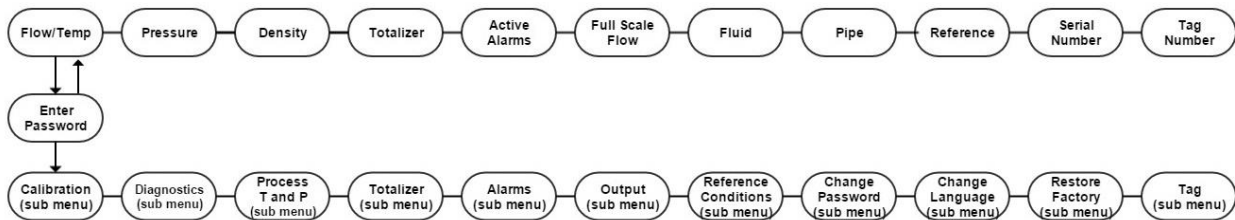

Copy of Table 2: Diagnostics Sub-Menu

Diagnostics (Sub-Menu)

In the Diagnostics Sub-Menu, you can:

- Quickly determine meter status
- View any detected hardware errors
- Read the maximum and minimum values that the flow meter has measured.
- Tune the meter for optimal performance
- Simulate flow, frequency, temperature, pressure, viscosity, and density

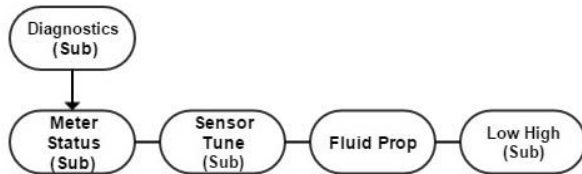







Table 4: Diagnostics Sub-Menu

Navigate to the Diagnostics (Sub Menu). Push enter key  to reach the next lower level.

Use the left  and right  buttons to view the Diagnostics sub-menus. Meter Status, Low/High, Sensor Tune, and Fluid Properties have sub-menus. Push the enter key  to reach the next lower level.

	More extensive diagnostics are available via the Smart Interface Portal (SIP) software.
---	---

Meter Status (Sub-Menu)

In the Meter Status sub-menu, you can check the meter status.

	An error condition is indicated by a “!” in the main display.
---	---

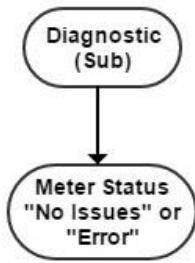



Table 5: Meter Status Sub-Menu

Navigate to the Diagnostics (Sub Menu). Push enter key  to reach the Meter Status sub-menu.

The meter will report the status of your meter as either “No Issues” or it will display the detected Error descriptions. If more than one issue is detected, they will all scroll together beneath the “Meter Status” heading.

	<p>If errors are present, customers are urged to use the Sensor Tune menu and SIP ValidCal Diagnostics to analyze the problem.</p>
---	--

The following error descriptions may be present:

- Flow Sensor
- Temperature Issues
- Temperature Overrange
- Pressure Transducer Issues
- Pressure Transducer Overrange
- SD Card Issues
- UART Issues
- MCU Voltage Issues
- Main Board Button Stuck
- Digicomms Fail
- Signal Noise

A description of each follows.

Flow Sensor Issues

Possible Cause of Error Code

1. The flow sensor may have been damaged.

This can be caused by water hammer or excessive velocity.

Solution:

- Go to the **Low/High** Sub-Menu (See Table 8) button, and check the highest velocity recorded.
- The max velocity spec is 30 fps for a liquid; 300 fps for a gas. If these velocities have been exceeded, the sensor may have been damaged.
- Pull the meter and check for visible damage.

2. The set-up or installation may be incorrect.

Solution:

- Verify the installation:
 - For 240i, make sure nothing is clogging the flow body or building up around the flow sensor.
 - For 241i, verify insertion depth and meter orientation are correct.
- Verify the cabling
 - No power wires in the same conduit as the signal wires. This can couple noise into the line, especially if powered by AC.
 - No cable splices. If additional cable is added to the meter, this can lead to an attenuated vortex signal which is of insufficient strength for the meter electronics to process.
- Verify meter is properly Earth grounded.

Temperature Issues

Since mass flow is determined by calculating density from **Temperature** and Pressure, this may cause errors in the flow readings as well.

240i/241i VT and VTP meters have one 1000 ohm PRTD for measuring process temperature.

Temperature ranges:

ST: -40F to +392F (-40C to +200C)

Possible Cause of Error Code

1. Temperature channel calibration is incorrect/ corrupted.

Solution:

- Contact Sierra for remote troubleshooting.
- If this is not immediately possible, temperature may be simulated in the Fluid Properties sub-menu.

2. Temperature sensor has failed (often evidenced by a very HIGH temperature reading on the display).

Solution:

- Check the Low/High sub-menu to see if the meter's temperature limits have been exceeded.
- The meter may need to be [returned to the factory](#). If this is not immediately possible, temperature may be simulated in the Fluid Properties sub-menu.

3. Remote wiring is incorrect.

- Check that remote wiring is as shown in Figure 19 of this manual.

Temperature Overrange

Since mass flow is determined by calculating density from **Temperature** and Pressure, this may cause errors in the flow reading as well.

240i/241i VT and VTP meters have one 1000 ohm PRTD for measuring process temperature.

Temperature ranges:

ST: -40F to +392F (-40C to +200C)

Possible Cause of Error Code

1. Process Temperature exceeded Temperature sensor limits.

Solution:

- Adjust process conditions to remain within Temperature sensor range.
- Remove meter from process until Temperature is within sensor range.

2. Temperature calibration is incorrect/ corrupted.

Solution:

- Contact Sierra for remote troubleshooting.
- If this is not immediately possible, temperature may be simulated in the Fluid Properties sub-menu.

3. Temperature sensor has failed (often evidenced by a very HIGH temperature reading on the display).

Solution:

- Check the Low/High sub-menu (see Table 8) to see if the meter's temperature limits have been exceeded.
- The meter may need to be [returned to the factory](#). If this is not immediately possible, temperature may be simulated in the Fluid Properties sub-menu.

Pressure XDCR Issues

Since mass flow is determined by calculating density from Temperature and **Pressure** this may cause errors in the flow readings as well.

240i/241i VTP meters have one transducer for measuring process pressure.

Pressure Ranges:

MP0: No pressure input (incompressible liquids)

MP1: 30 psia

MP2: 100 psia

MP3: 300 psia

MP4: 500 psia

Possible Cause of Error Code

1. The pressure calibration is incorrect/ corrupted.

Solution:

- Contact Sierra for remote troubleshooting.
- If this is not immediately possible, pressure may be simulated in the Fluid Properties sub-menu.

2. The sensor has failed.

Solution:

- Check the Low/High sub-menu (see Table 8) to see if the meter's pressure limits have been exceeded.
- The meter may need to be [returned to the factory](#). If this is not immediately possible, pressure may be simulated in the simulate submenu.

3. Remote wiring is incorrect

Solution:

- Check that remote wiring is as shown in Figure 19.

Pressure XDCR Overrange

Since mass flow is determined by calculating density from Temperature and **Pressure** this may cause errors in the flow readings as well.

240i/241i VTP meters have one transducer for measuring process pressure.

Pressure Ranges:

MP0: No pressure input (incompressible liquids)

MP1: 30 psia

MP2: 100 psia

MP3: 300 psia

MP4: 500 psia

Possible Cause of Error Code

1. Process pressure exceeded pressure sensor limits.

Solution:

- Adjust process conditions to remain within pressure sensor range.
- Remove meter from process until pressure is within sensor range.

2. The pressure calibration is incorrect/ corrupted.

Solution:

- Verify wiring, especially if unit is remote. See Figure 19.
- Contact Sierra for remote troubleshooting.
- If this is not immediately possible, pressure may be simulated in the Fluid Properties sub-menu.

3. The sensor has failed.

Solution:

- Check the Low/High sub-menu (see Table 8) to see if the meter's pressure limits have been exceeded.
- The meter may need to be [returned to the factory](#). If this is not immediately possible, pressure may be simulated in the simulate submenu.

SD Card Issues

240i/241i meters have one SD Card for storing meter data.

Possible Cause of Error Code

1. The SD Card is missing.

Solution:

- Replace the SD Card if available.
- Contact Sierra for a replacement SD Card.

2. The SD Card is damaged.

Solution:

- Contact Sierra for replacement card

UART Issues

240i/241i meters have multiple Universal Asynchronous Receiver/Transmitters (UART) for communications (ex. USB).

Possible Cause of Error Code

1. UART is malfunctioning.

Solution:

- Contact Sierra for remote troubleshooting.
- The meter may need to be [returned to the factory](#).

2. UART is damaged/disconnected.

Solution:

- The meter may need to be [returned to the factory](#).

MCU Voltage Issues

240i/241i meters have a Microcontroller (MCU) with a nominal voltage range.

Possible Cause of Error Code

1. MCU is malfunctioning.

Solution:

- Contact Sierra for remote troubleshooting.
- The meter may need to be [returned to the factory](#).

2. MCU has failed.

Solution:

- The meter may need to be [returned to the factory](#).

Main Board Button Stuck

240i/241i meters have display buttons for navigation and data entry.

Possible Cause of Error Code

1. Main board button stuck down.

Solution:

- Attempt to unstick buttons manually.
- Contact Sierra for remote troubleshooting.
- The meter may need to be [returned to the factory](#).

Digicomms Fail

240i/241i meters can be ordered with Digital Communications (Hart, Profibus, Foundation Fieldbus, etc.).

Possible Cause of Error Code

1. Digital Communications malfunction.

Solution:

- Contact Sierra for remote troubleshooting.
- The meter may need to be [returned to the factory](#). If this is not immediately possible, output via 4-20 mA, RS232, or USB is available.

Signal Noise

240i/241i meters are sensitive to background noise or vibration in the application environment (60 Hz/50 Hz from power lines).

Possible Cause of Error Code

1. Meter Settings may need to be adjusted.

Solution:

- Go to Diagnostics, then Sensor Tune menu (See Table 6) and check Ck and Minimum Noise Level. Reset these values if necessary.
- Contact Sierra for remote troubleshooting.

2. Meter Earth Ground is faulty.

Solution:

- Verify meter is properly earth grounded.

3. Flow sensor may be damaged/miswired.

Solution:

- Contact Sierra for remote troubleshooting.
- The meter may need to be [returned to the factory](#).

Once you have completed your review of the Meter Status sub-menu press exit ⊗ to return to the sub-menus, or use the left ◀ and right ▶ buttons visit other menus in the diagnostics menu (see Table 4).

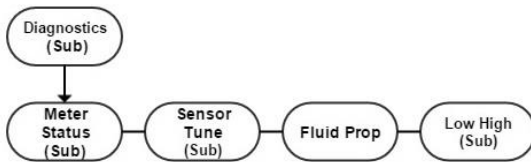

Copy of Table 4: Diagnostics Sub-Menu

Sensor Tune (Sub-Menu)

The Sensor Tune sub-menu should be used for fine-tuning and troubleshooting the meter settings.

	Use the SIP ValidCal Diagnostics routine and Meter Status sub-menu to verify mechanical and electrical performance.
	Watch Video Tutorial – a video tutorial for this function is available on the USB flash drive provided in the product shipment.

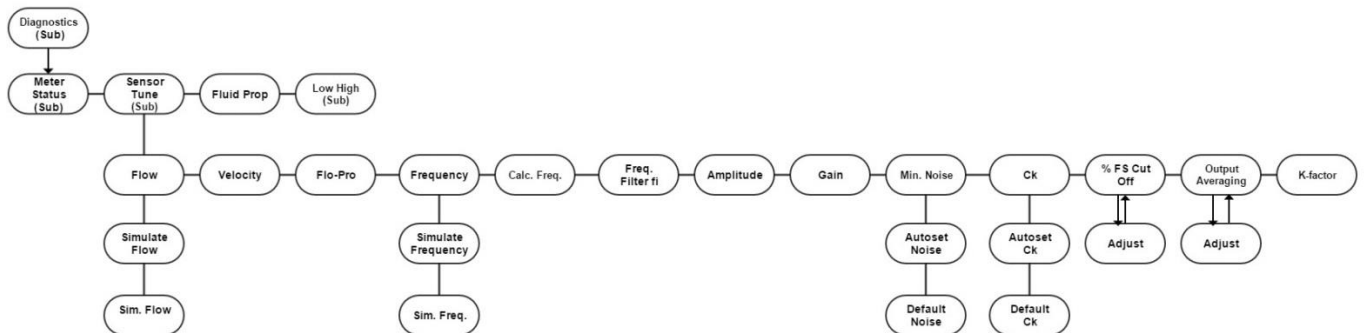







Table 6: Sensor Tune Sub-Menu

Navigate to the Diagnostics (Sub-menu). Push enter key  to reach the next lower level. Use the left  and right  buttons to reach Sensor Tune sub-menu. Push the enter key  to enter Sensor Tune sub-menu. Use the left  and right  buttons to move between menu screens under the Sensor Tune sub-menu.

Flow: The Flow menu displays the current flow rate along with the units.

Flow ft³/m
101.32

Velocity: The Velocity menu displays the current fluid velocity with units. Units are either meters per second or feet per second depending on the flow units. The higher the flow rate, the higher the velocity.

Velocity FPS
19.102

Flo-Pro: The flow-Pro menu displays the current flow profile value being used by the meter.

Flo-Pro
135.0

Frequency: The Frequency menu displays the real-time frequency output of the vortex sensor in Hertz. The higher the flow, the higher the frequency.

Frequency Hz
135.0

Calculated Frequency f: The Calculated Frequency menu displays the expected sensor frequency based on current flow rate and K-Factor. Calculated Frequency should always be very close to the measured sensor frequency. This allows for a valuable real-time check that all flow and signal strength inputs are correct.

Calc. Freq. f
135.12

Dynamic Frequency Filter fi: The Dynamic Frequency Filter menu displays the frequency at which a low pass filter is applied. In a low pass filter, the filter passes all frequencies lower than the setting, and filters out higher ones. This value is calculated using the current sensor Amplitude and Gain along with the set value for Vortex Coefficient Ck. The “fi” value should be approximately 20-25% above the actual sensor frequency.

Frequency Hz
100.0

Freq. Filter fi
125.35

In the example above, all frequencies *above* 125.35 Hz will be filtered out.

Amplitude: The Amplitude menu displays the current sensor amplitude. Strong flow signals will have amplitudes in the range of 2000 to 4000. The strength of the flow signal is dependent on the density and velocity of the fluid.

Amplitude 2854.32

Gain: The Gain menu displays the current Gain Stage. Gain is the ratio of the output to the input. There are eight Gain Stages from no gain to full gain (1.0, 3.33, 10.0, 33.33, 100.0, 333.33, 511.0, 1697.0).

At low flow rates, the signal is weak and requires amplification to detectable levels. In this case, Amplitude is low and the Gain value is high. As flow rate increases, the Amplitude will build until it reaches a maximum, then the Gain will drop to the next lower level (from 333.33 to 100 to 33.3 etc.). If flow rate continues to increase, the Amplitude will build again, and the Gain stage will drop. So, a very strong flow signal will result in Amplitude of 2000- 4000 and a Gain of 1.0.

Gain 3.33

Minimum Noise Level: The Minimum Noise Level menu displays a value used for noise cutoff at zero flow. Electrical or vibrational noise that the sensor detects from the surrounding application environment (e.g. 60 Hz from power lines) can result in flow output when there is no actual flow.

In general, the Minimum Noise Level should be a value slightly higher than the value of the Amplitude divided by the Gain detected by the sensor at zero flow.

For example, if Amp = 900 and Gain = 100 at zero flow, then Amp/Gain = 9. A Minimum Noise Level > 9 will cut off unwanted noise, which if not done the meter would interpret as flow.

Min. Noise 9.2

	As the Minimum Noise Level setting increases, the potential for cutting off actual low flow readings increases. If the target flow rate is being cut off, reduce the Minimum Noise Level.
---	---

Vortex Coefficient Ck: The Vortex Coefficient Ck menu displays the current value set for Ck. Ck is used in the placement of a Low Pass Noise Filter which helps to avoid false frequency readings. Ck is calculated based on Frequency, Amplitude, and Gain along with the Density of the fluid under flow.

Ck
21.1

In general, the Ck should result in a Dynamic Frequency Filter that is 20-25% higher than the actual Sensor Frequency.

Frequency Hz
10.0

Freq. Filter fi
12.5

	As the Ck value increases, the window for detecting frequency widens and can eventually allow in anomalous higher frequencies. Reduce the Ck value if the Dynamic Frequency Filter value is more than 25% greater than the Sensor Frequency
---	---

% FS Cutoff: The % FS Cutoff menu displays the current value of the percent of Full Scale cutoff. For any flow rate lower than this percentage, the meter is forced to show no flow. This is useful if there is persistent noise or vibration in the pipe that is causing erroneous readings at low flow rates.

For example, if the full scale is 100 Kg/hr, then setting the % FS Cutoff to 5% of full scale will not allow the meter to show flow less than 5 kg/hr.

% FS Cutoff
5.0

Output Averaging: The Output Averaging menu displays the number of seconds for which output is averaged. Output Averaging allows for smoothing of noisy flow over time.

The meter samples the flow every 1 second (1 Hz). This value is fixed. Output Averaging will compute a rolling average of each reading over the requested time span.

For example, if the value is set to 5, then the flow output will always be a running average of the last 5 seconds of flow.

Output Averaging
5

	As the Output Averaging value increases, meter response time will also increase.
---	--

K-Factor: The K-Factor menu displays the current value for K-Factor. The K-Factor value is determined during meter calibration based on Frequency and Flow Rate.

K-Factor
17.6



K-Factor is a calibration constant and cannot be adjusted.

Simulation Status: For the Flow and Frequency menus, use the ▼ key to navigate to the Simulation Status menu. Push the enter key ↵ to change the status.

Simulate Flow
Yes

Simulate Value: For the Flow and Frequency menus, use the ▼ key to navigate to the Simulation Value menu. Push the enter key ↵ and use ◀▶ to edit the value.

Sim. Freq.
Yes

Adjust Value: For the Minimum Noise Level, Vortex Coefficient Ck, % FS Cutoff, and Output Averaging menus, the value can be adjusted. Push the enter key ↵ to begin editing. Use ◀▶ to edit the value. When finished editing, push the enter key ↵ again to save the value.

Flow ft3/m
100.0

Autoset Value: For the Minimum Noise Level and Vortex Coefficient Ck menus, the value can be Autoset. Use ▼ key to navigate to the Autoset window. Push the enter key ↵ to autoset the value. The new value will then be displayed.

Autoset Ck
21.2

Default Value: For the Minimum Noise Level and Vortex Coefficient Ck menus, the value can be reset to a default value. Use ▼ key to navigate to the Default window. Push the enter key ↵ to reset the value to default. The new value will then be displayed.

Default Ck
20.0

Troubleshooting Meter Settings

Use the “Sensor Tune” sub-menu to troubleshoot your meter.

	<p>Watch Video Tutorial – a video tutorial for this function called “Meter Tuning” is available on the USB flash drive provided in the product shipment.</p>
---	---

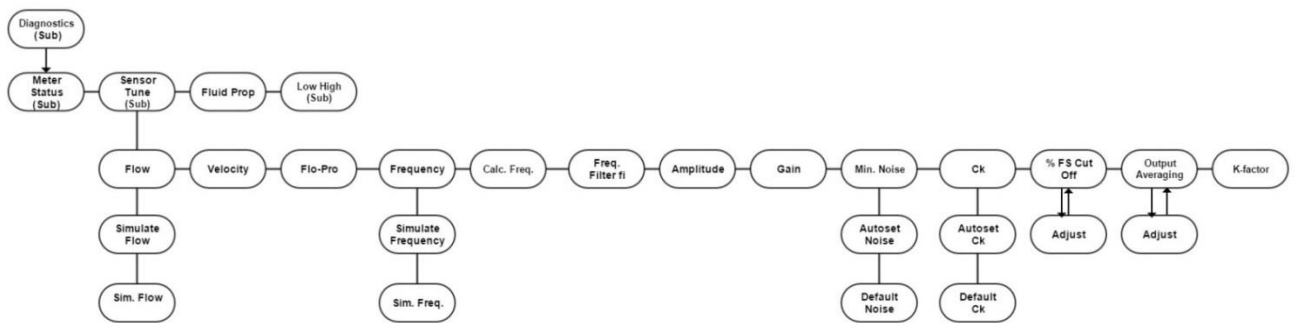



Copy of Table 6: Sensor Tune Sub-Menu

Case I: Meter shows no flow when you know there is flow

Solution 1: Check the flow velocity.

- The flow velocity is too low. The Vortex meter has minimum velocity requirements shown in Figure D on page 10. If the velocity is below this, the meter generally cannot measure this flow. No vortex meter can measure down to zero flow as the velocity must be enough to form the vortices that the meter uses to make its flow measurement.
- In some cases (very low noise and vibration) the meter may be able to measure lower than the minimum.

	<p>The “Min/Max Dial” image indicates parameters of % Full Scale, Cut Off, Minimum Noise Level, and Ck that can be adjusted and tuned.</p>	
---	--	---

Solution 2: Check the % FS Cutoff.

- The % FS Cutoff is set as a percent of full scale and the meter will not be allowed to read below the % FS Cutoff setting. Perhaps you have set it too high? If you discover you do have the setting too high, adjust using the % FS Cutoff menu. You can adjust the % FS Cutoff from 1% to 50% of full scale flow.



Case II: Meter shows flow, but you know there is zero flow

Solution 1: Check the Minimum Noise Level.

- The Minimum Noise Level may be set too low. This will allow false flow signals caused by noise or vibration to be seen. The Minimum Noise Level must be set above the level of this noise/vibration to cut it out. To do this, **Autoset** the value. With NO FLOW in the pipe, perform an Autoset and the meter will sense the noise and vibration present, and set the Minimum Noise Level just above this.



For a very noisy environment, the Minimum Noise Level setting can result in cutting off low flow rates.

Case III: Meter Shows Erratic Flow Output

Solution 1: Check the measured velocity.

- The flow rate may be too low, just at the cutoff of the meter range, and the flow cycles above and below the cutoff making an erratic output.

Solution 2: Check the installation.

- Mechanical installation may be incorrect. Verify the straight run is adequate as described in Chapter 2. For in-line meters, make sure the meter is not installed backwards and there are no gaskets protruding into the flow stream. For insertion meters, verify the insertion depth and flow direction.

Solution 3: Check the Minimum Noise Level.

- Check the Minimum Noise Level. It may be possible to lower the value to increase the meter range. See case above. Again, lowering the Minimum Noise Level will allow more noise/vibration into the meter and the meter will eventually lose the true flow signal in this noise.



Solution 4: Check the Output Averaging setting.

- Check the Output Averaging setting. The meter may be reacting to actual changes in the flow stream. The output can be smoothed using averaging. The meter samples the flow every 1 second (1 Hz). This value is fixed. The output will compute a rolling average of each reading over the requested time span. For example 5 seconds will average the last 5 readings together.



Solution 5: Check f, fi, and Ck settings.

- Check f, fi and Ck. The vortex coefficient Ck may be incorrectly set. The Ck is a value in the equation used to determine if a frequency represents a valid vortex signal given the fluid density and signal amplitude. In practice, the Ck value controls the adaptive filter (fi) setting. During flow, view the f and fi values. The fi value should be approximately 10-20 % higher than the f value. This is a low pass filter, so all frequencies below fi can be seen by the Vortex meter. You may need to adjust Ck to filter out noise that has a higher frequency than the flow signal. See Ck Adjust



Fluid Properties (Sub-Menu)

The Fluid Properties sub-menu allows you to simulate temperature and pressure to simulate viscosity and density for fluids that are not in the meter's fluid database.

	<p>Note density and viscosity are dependent on temperature and pressure, so these values are only valid at the temperature and pressure they are specified for.</p>
---	---

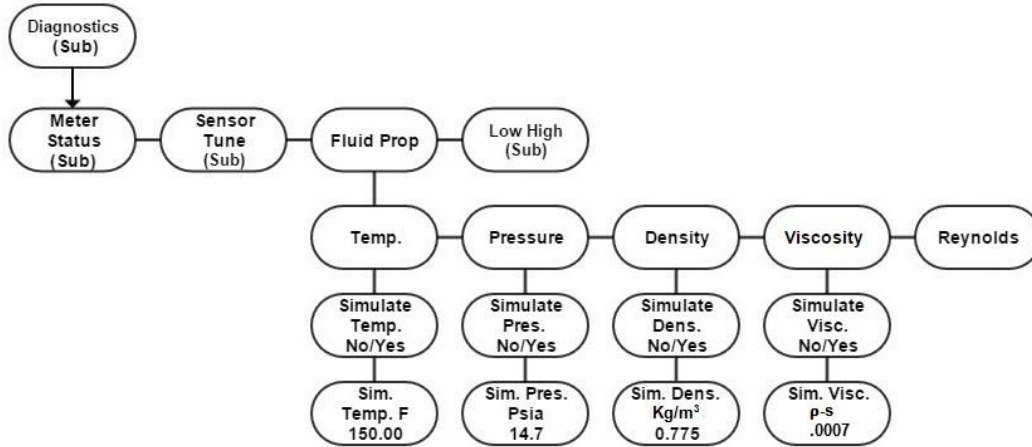

Table 7: Fluid Properties Sub-Menu

Navigate to the Diagnostics (Sub-Menu). Push enter key \leftarrow to reach the “Fluid Properties.” Use the left \blacktriangleleft and right \blacktriangleright buttons to move between menu screens under the Fluid Properties sub-menu.

Temperature: The Temperature menu displays the current fluid temperature value along with the units.

<p>Temperature C 178.00</p>

Pressure: The Pressure menu displays the current fluid pressure value along with the units.

<p>Pressure psia 14.69</p>

Density: The Density menu displays the current fluid mass density value along with the units. The density value is calculated based on Temperature and Pressure, unless it is being simulated.

<p>Density kg/m³ 999.9</p>

Viscosity: The Viscosity menu displays the current fluid dynamic viscosity value along with the units. The viscosity value is calculated based on Temperature and Pressure, unless it is being simulated.

Viscosity Pa-s
0.0001

Reynolds Number: The Reynolds number is a dimensionless calculated value and is used for troubleshooting. In most cases, it will be above 5,000.

Reynolds
25000

Simulation Status: For the Temperature, Pressure, Density, and Viscosity menus, use the ▼ key to navigate to the Simulation Status menu. Push the enter key ↵ to change the status.

Simulate Temp.
Yes

Simulate Value: For the Temperature, Pressure, Density, and Viscosity menus, use the ▼ key to navigate to the Simulation Value menu. Push the enter key ↵ and use ◀▲▼▶ to edit the value.

Sim. Temp. C
22.111

Once the value is entered, push the enter key ↵ to save and ▶▶ to reach the fluid properties, ◀▶ to scroll through them, and exit ⊗ to go to the Diagnostics submenu.

	Values will remain as “simulated” until the simulation is turned off.
---	---

This concludes the Meter Tune sub-menu. Press ⊗ to exit diagnostic menu.

Low/ High (Sub-Menu):

The Low High (Sub-Menu) displays minimum and maximum flow, pressure, temperature and velocity. This is useful for diagnostics purposes.

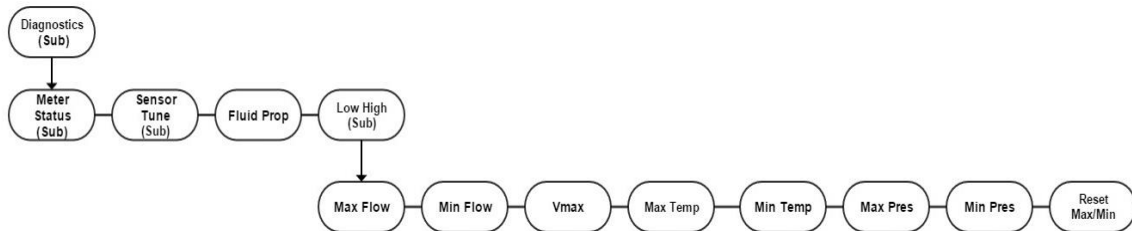







Table 8: Low/High Sub-Menu

Navigate to the Diagnostics (Sub Menu). Push the enter key  to reach the next lower level. Use the left  and right  buttons to reach the Low/High sub-menu. Hit the enter key  to reach the next lower level of menu. Use the left  and right  buttons to move between menu screens under the Low/High sub-menu.

Max Flow: The Max Flow menu displays the maximum recorded flow value along with the units.

Max Flow ft ³ /min 130.3
--

Min Flow: The Min Flow menu displays the minimum recorded flow value along with the units.

Min Flow ft ³ /min 5.6

	For all meters, the maximum velocities are: liquids 30 fps (9.1 mps) and gases 300 fps (91.4 mps). Exceeding these velocities may damage the temperature and velocity sensors, as well as other meter internals exposed to the process flow.
---	--

Vmax: The Vmax menu displays the maximum recorded velocity value along with the units.

Vmax 24.565

Vmin: The Vmin menu displays the minimum recorded velocity value along with the units.

Min Flow ft ³ /min 1.0558

Max Temp: The Max Temp menu displays the maximum recorded temperature value along with the units.

Max Temp C 178.32

Min Temp: The Min Temp menu displays the minimum recorded temperature value along with the units.

Min Temp C -21.5



For VT or VTP meters, the minimum and maximum temperature limits are -40F to +392F (-40C to +200C). Operating outside of these limits could damage the velocity sensor.

Max Pres: The Max Pres menu displays the maximum recorded pressure value along with the units.

Max Pres psia
89.53

Min Pres: The Min Pres menu displays the minimum recorded pressure value along with the units.

Min Pres psia
1.54



For VTP meters, the maximum pressure is the rating of the pressure transducer. Exceeding the maximum pressure rating of the pressure transducer may damage the transducer.

Pressure Ranges:

MP1: 30 psia

MP2: 100 psia

MP3: 300 psia

MP4: 500 psia

Reset Max/Min: To reset all recorded Max and Min values, push the enter key ↵ once to bring up the Y value. If you wish to proceed with the reset, push the enter key ↵ again.

Reset Max/Min
Y

Press exit ⊗ to return to the diagnostics sub-menu .

Process Temperature and Pressure (Sub-Menu)

Navigate to the Process Temperature and Pressure Sub Menu, use Table 9 below for guidance if necessary. The screen will look like this:

Process T and P
(Sub-Menu)

The InnovaMass 240i and 241i is a can be ordered as a *multivariable* mass flow meter. It will always measures mass velocity (from which the mass flow rate is derived) and optionally temperature (VT option) and process pressure in addition to VT, called (VTP option). The Process Temperature and Pressure Sub-Menu allows you to input the desired units and enter the process temperature and pressure for volumetric flow only (V option) and volumetric and temperature meters (VT option).

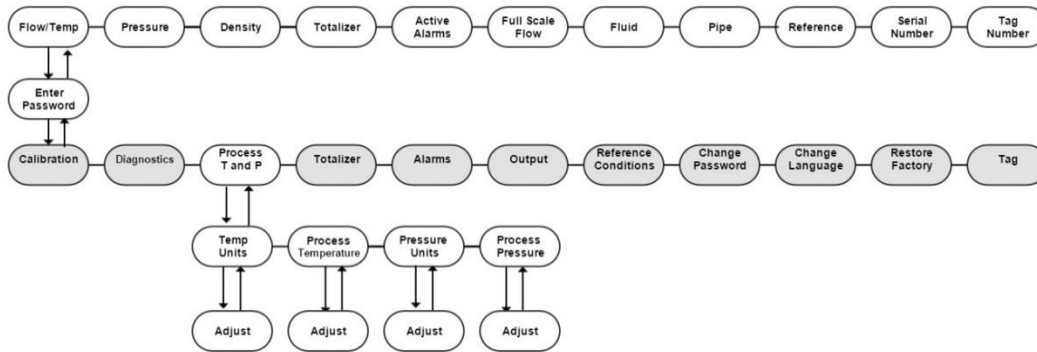
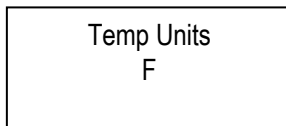

Table 9: Process Temperature and Pressure Sub-Menu

Process Temperature (Sub-Menu): Temperature Units

From the Process Pressure menu press button to move to the Temperature Units menu to enter the units for temperature. Use Table 9 for guidance if necessary. The display will show the currently selected temperature unit. For example:



Press enter and the units will begin flashing. Use the up and down keys to select. The units will flash. Once the temperature units have been selected press enter to save.

Choices Available:

- F (Fahrenheit)
- C (Celsius)
- K (Kelvin)
- R (Rankine)

This concludes our review of the Process Temperature Units menu. Press to go to the Process Temperature menu or exit to climb back up to the main menu.

Process Temperature Sub-Menu: Process Temperature

From the Temperature Units menu press button to move to the Process Temperature menu. Use Table 3: Calibration Sub-Menu for guidance if necessary. The display will show the currently selected process temperature.

	The “Process Temperature Sub-Menu: Process Temperature” is only applicable in V units. VT and VTP will have this real time.
--	---

	The process temperature can also be simulated in the “Diagnostics Sub-menu.”
---	--

For example:





Process Temp 100 F

This process temperature is used by the instruments’ Raptor II operating system to improve fluid property calculations.

The units of the temperature in this menu are the same as what was set in the previous menu. In the example above, the units are F since this is what was set in the temperature units sub-menu.

Process Pressure (Sub-Menu): Pressure Units



Use this menu to enter the units for pressure.

Use the enter key  to drill down to pressure units selection. Press enter  and the units will begin flashing. Use the   buttons to enter the desired information, and the enter key  to save the value.

Pressure Units Psia

Available units are:

- Psia
- Psig
- Bar A
- Bar G
- KPa A
- KPa G
- Kg/CM2 A
- Kg/CM2 G
- In H2O A
- In H2O G
- MM H2O A
- MM H2O G



Once the pressure units have been selected press the enter key  to save. You can press the exit  several times to climb back up to the main menu level or press  to proceed to the next Sub-Menu called Process Pressure.

Process Pressure Sub-Menu: Process Pressure

Use this menu to enter the process pressure.

	The “Process Pressure Sub-Menu: Process Pressure” is only applicable in V and VT units, VTP will have this real time.
---	---



Process Pressure 14.700000

As in previous examples, use the  buttons to enter the desired value, and the enter key  to save the value.

Process pressure is used by the instruments Raptor II operating system to improve gas property calculations. Gas properties have a very slight dependence on pressure, so if process pressure changes appreciably over time this value should be updated to reflect process conditions.

	The process pressure can also be simulated in the “Diagnostics Sub-menu.”
--	---

The units of the pressure in this menu are the same as what was set in the previous menu. In the example above, the units are 14.700000 Psia since this is what was set in the pressure units sub-menu.

This concludes our review of the Process Pressure menu. Press  to go to the Temperature Units menu or exit  to climb back up to the main menu.

This concludes our review of the Process Pressure Sub-Menu. Press the exit  climb back up to the main menu.

Totalizer (Sub-Menu)

The Totalizer Sub-Menu controls all aspects of the totalizer function.

	Watch Video Tutorial – a video tutorial for this function called “Local Display Interface Navigation” is available on the USB flash drive provided in the product shipment.
---	--

Navigate to the Totalizer (Sub-Menu) screen. Use Table 10 below for guidance. You will see this screen:

Totalizer (Sub-Menu)

Totalizers are used to monitor accumulated flow, often for billing and cost allocation purposes. The totalizer sub-menu is used to turn the totalizer ON or OFF, to reset, and to tell the meter when to send out a totalizer pulse and what that pulse should look like.

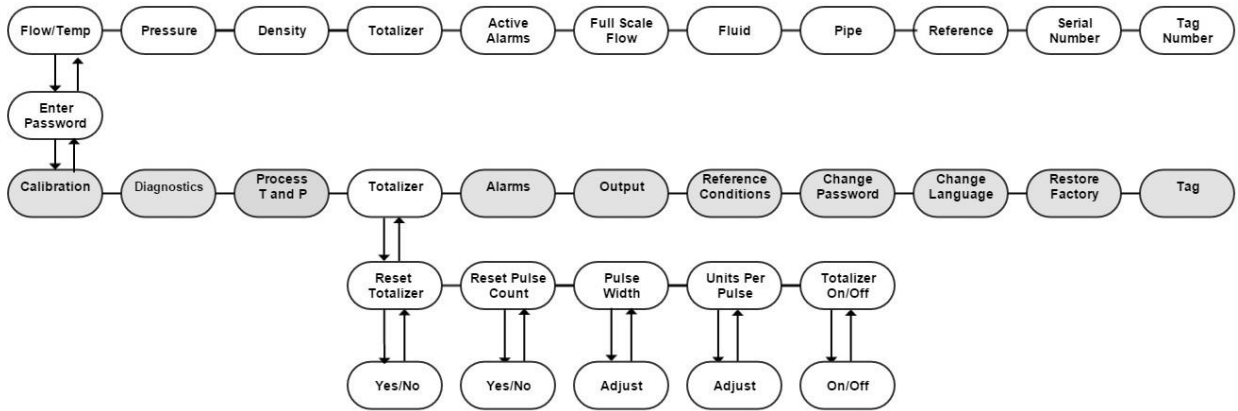
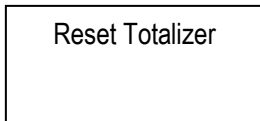

Table 10: Totalizer Sub-Menu

Totalizer (Sub-Menu): Reset Totalizer

Use this menu to reset the totalizer to zero. From the Totalizer (Sub-Menu) screen press enter and you will see a screen like this:



Pressing enter again will show a flashing “Yes”. The screen will look like this:

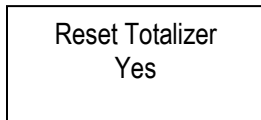

Use the up and down keys to toggle between “Yes” and “No”. Make your selection and then press enter to finalize the selection and be automatically sent back to the Totalizer (Sub-Menu).

Totalizer Sub-Menu: Reset Pulse Count

From the Totalizer Reset screen press to move to the Reset Pulse Count menu. If you need to actually set up the totalizer (rather than just reset it to zero), navigate to the Unit per pulse screen. Use Table 10 above for guidance.

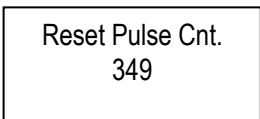

Use this menu to reset the pulse counter. The pulse count is the count of pulses that went to the pulse relay since the last reset. This count will match your external counter if they were both reset at the same time and can be used to verify an external counter. Pulse count X units per pulse= totalizer count within +/- 1 units per pulse value.

In the example below, there were 349 pulses since the last reset.

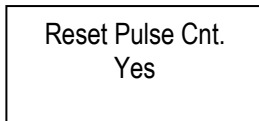

To reset this to zero, press enter  and a “Yes” will appear and flash.



Use the up  and down  keys to toggle between “Yes” and “No”. Make your selection and then press enter  to finalize the selection.

If you answered YES, the count will read zero “0”.

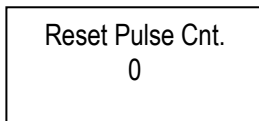







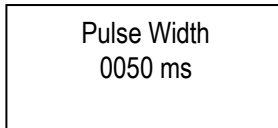

Totalizer (Sub-Menu): Pulse Width

From the Reset Pulse Count screen press  to move to the Pulse Width menu. Use this menu to set the width of each pulse in milliseconds. Navigate to the “Pulse Width” screen. Use Table 10 above for guidance.

The pulse output is an isolated relay contact. For example, one pulse of 50ms closes the normally open relay for 50ms. Some counters work straight off of the relay contacts closing and some pull up the relay so when it closes it is a negative 50ms pulse. The 240i and 241i can use just the contacts or an approximately 10K pull-up resistor.



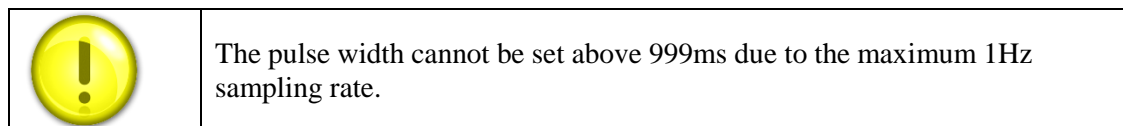

Press enter  and the units will begin flashing. As in previous examples, use the     buttons to enter the desired value, and the enter key  to save the value.

Press the up  button or down  button to choose the desired pulse. Next, press the enter key  to save. The pulse width can be from 1 to 999ms.



In the screen example above, the pulse width will close the isolated normally open contacts for 50ms. The frequency of the pulse varies with flow rate and units per pulse value but cannot exceed 1Hz maximum.

You can press the exit  several times to climb back up to the main menu level or press  to proceed to the next Sub-Menu called Units Per Pulse.

Totalizer (Sub-Menu): Units Per Pulse

Use this menu to select the units per pulse. Navigate to the “Units Per Pulse” screen. Use Table 5 for guidance if necessary. **Note the maximum frequency at which the totalizer can count is 1 pulse per second or 1 Hz.** This puts a limit on the units per pulse and makes resolution dependent on flow rate.







For example, assume the maximum flow rate is 100 scfm and you want the totalizer to pulse every 5 scf. Since the flow is 100 scfm, it will take 5/100 minutes, or 3 seconds to totalize 5 scf. That is acceptable since the totalizer takes longer than 1 second to accumulate scf.



Assume that now you want more resolution, so you would like the totalizer to pulse every 1 scf. Since the flow is 100 scfm, it will take 1/100 minutes, or 0.6 seconds to totalize 1 scf. Since the instrument’s totalizer is 1 Hz, it can’t pulse any faster than a maximum rate of once per second (1 Hz).

In this example, the best units per pulse would be 1.7 scf; that is over the 1 HZ maximum sampling rate.





$$\frac{1 \text{ SCF}}{.6 \text{ seconds}} \times \frac{\text{second}}{\text{pulse}} = 1.7 \frac{\text{SCF}}{\text{pulse}}$$

Units per pulse 1.700000

Press enter  and the units will begin flashing. As in previous examples, use the     buttons to enter the desired value, and the enter key  to save the value.

Press  to proceed to the Totalizer On/Off screen or press the exit  several times to climb back up to the main menu level.

Totalizer (Sub-Menu): Totalizer On/Off

Use this menu to turn the totalizer “On” or “Off.” Use Table 10 for guidance if necessary. Press enter  and the variable will begin flashing. As in previous examples, use the   buttons to select “On” or “Off,” and press enter  to save the value.

	The units of the totalizer are the same as entered in the units menu (minus the time since this is an accumulation and not a rate).
---	---

Totalizer On/Off On

Totalizer set up is now complete. This concludes our review of the Totalizer (Sub-Menu). Press exit  to climb back up to the main menu.

Alarm (Sub-Menu)

The alarm sub menu controls all aspects of the 240i and 241i alarm feature. The instrument can be set to alarm on *one* of the following variables: flow, pressure, temperature or totalizer. Navigate to the Alarm (Sub-Menu) screen. Use Table 11 below for guidance. You will see this screen:

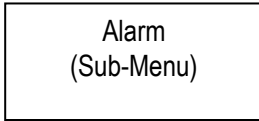

The instrument alarm can be set on *one* of the following conditions: low, high or window. The Window alarm becomes active when the parameter reads higher or lower than the low/high settings (when it is outside of its “operating window”).

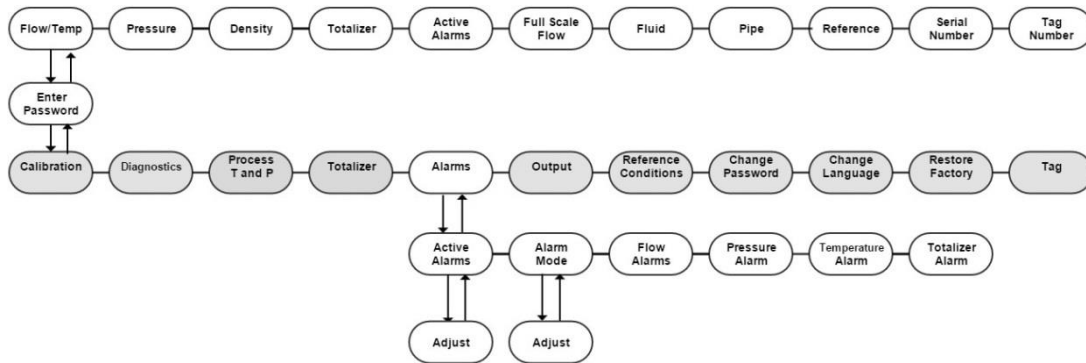
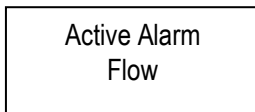

Table 11: Alarm Sub Menu

Alarm (Sub-Menu): Active Alarm

Navigate to the Active Alarm screen. Use Table 11 for guidance. In the screen example below, the active alarm is “Flow”.



Available Choices:

Off





On (used only to test the alarm relay)



Flow

Pressure

Temperature

Totalizer

Press enter  and the variable will begin flashing. Use the   buttons to select On or Off, and then press enter  to save the value.

	<p>Only one alarm can be active at any one time. The alarm relay is a normally open isolated contact. The alarm is tripped when the relay closes.</p>
	<p>Watch Video Tutorial – a video tutorial for this function called “Local Display Interface Navigation” is available on the USB flash drive provided in the product shipment.</p>

You can press the exit ⊗ several times to climb back up to the main menu level or press ► to proceed to the next Sub-Menu called Alarm Mode.

Alarm (Sub-Menu): Alarm Mode

Navigate to the Alarm Mode screen. Use Table 11 above for guidance. Press enter ↵ and the variable will begin flashing. In the screen example below, the active alarm condition is “Low”. For example:

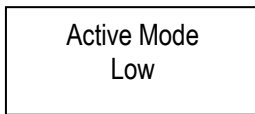

Available Choices:

High
Low
Window

Use the ▲▼ buttons to make selection and press enter (↵) to save the value.

Flow Alarms: Low and High Alarms

The Flow Alarms menu allows you to set the low and high alarm trip point values for flow.

Navigate to the Flow Alarms (Sub-Menu) screen. Use Table 12 for guidance. You will see this screen:

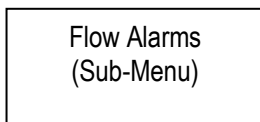

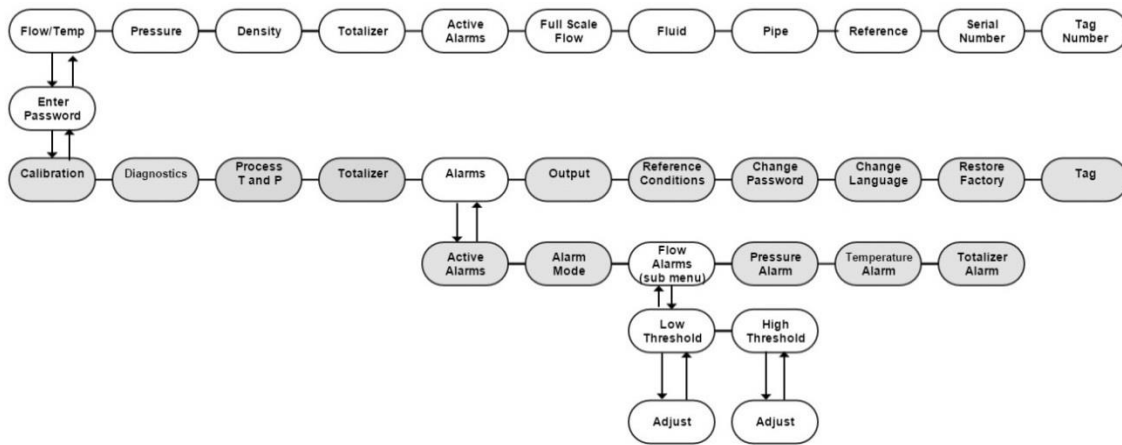
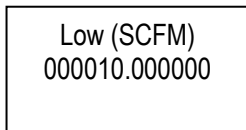

Table 12. Flow Alarms (Sub Menu)

For example, we will set a low flow alarm to demonstrate the alarms function. Navigate to the Flow Alarms (Sub Menu) screen. Assume that you already set the Active Alarm to “Flow” and the alarm condition is set to go off on a “Low” flow. The Flow Alarms menu allows you to set the actual alarm setpoint along with hysteresis.

Press enter and the units will begin flashing. As in previous examples, use the buttons to enter the desired numeric value, and the enter key to save the value.

In the example screen below, 10 scfm has been entered. The units were already set in the units menu.



If you wanted to set a “High Alarm,” press the right or left key and the “High Alarm” setup screen will appear.

	If you wanted to set the active alarm on pressure, temperature or totalizer (instead of flow), use Table 11 to navigate to the Active Alarm (Sub-Menu).
--	---

Pressure Alarm

Navigate to the Pressure Alarm screen. Use Table 11 above for guidance. You will see this screen:

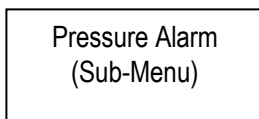

Press enter and a screen like this will show:

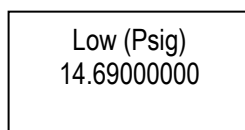

In the example screen above, 14.69 has been entered. The units were already set in the units menu. If you wanted to set a “High Alarm,” press the right or left key ◀▶ and the “High Alarm” setup screen will appear.

To change the settings on either high or low, press enter ↵ and the units will begin flashing. As in previous examples, use the ▲▼▶◀ buttons to enter the desired numeric value, and the enter key ↵ to save the value.

You can press the exit ⊗ several times to climb back up to the main menu level or press ▶ to proceed to the next menu called Temperature Alarm.

Temperature Alarm

Navigate to the Temperature Alarm screen. Use Table 11 above for guidance. You will see this screen:

Temp Alarm
(Sub-Menu)

Press enter ↵ and a screen like this will show:

Low (F)
70.00000000

In the example screen above, 70.00 has been entered. The units were already set in the units menu. If you wanted to set a “High Alarm,” press the right or left key ◀▶ and the “High Alarm” setup screen will appear.

To change the settings on either high or low, press enter ↵ and the units will begin flashing. As in previous examples, use the ▲▼▶◀ buttons to enter the desired numeric value, and then press the enter key ↵ to save the value.

You can press the exit ⊗ several times to climb back up to the main menu level or press ▶ to proceed to the next menu called Totalizer Alarm.

Totalizer Alarm

Navigate to the Totalizer Alarm screen. Use Table 11 above for guidance. You will see this screen:

Totalizer Alarm
(Sub-Menu)

Press enter ↵ and a screen like this will show:

Low (Gal)
500.00000000

In the example screen above, 500.00 has been entered. The units were already set in the units menu. If you wanted to set a “High Alarm,” press the right or left key ◀▶ and the “High Alarm” setup screen will appear.

To change the settings on either high or low, press enter ↵ and the units will begin flashing. As in previous examples, use the ▲▼▶◀ buttons to enter the desired numeric value, and then press the enter key ↵ to save the value.

You can press the exit ⊗ several times to climb back up to the main menu.

Output (Sub-Menu): Flow, Pressure and Temperature

The InnovaMass® 240i and 241i comes standard with linear 4 to 20 mA analog outputs for flow, temperature and pressure.

Navigate to the Output (Sub-Menu) screen. Use Table 13 below for guidance. You will see this screen:

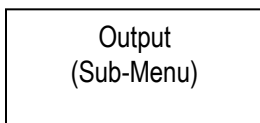

Temperature and pressure sensors are optional, so if this is a V or VT meter the 4-20 outputs will show the T and P as inputted in the Process temperature and pressure sub-menu (see Table 9).

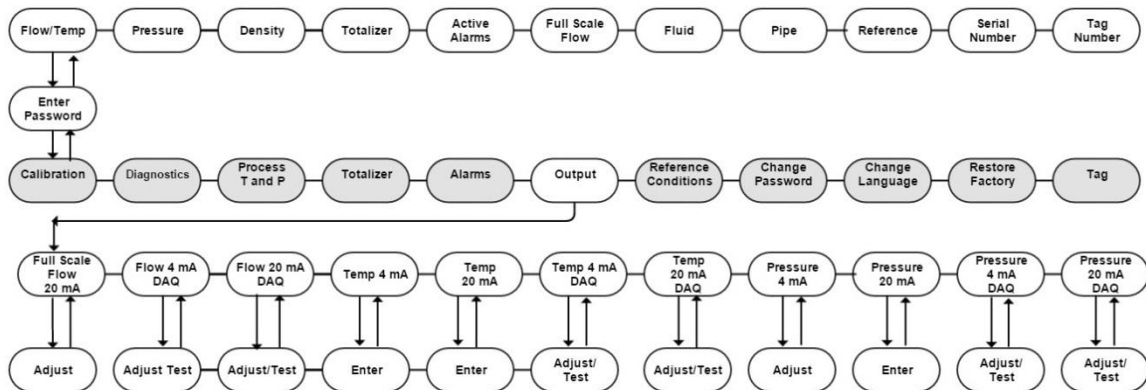

Table 13: Output (Sub Menu)

Use the output adjust menu to view, test, or adjust the 4 and 20mA raw digital DAC counts value for these parameters as well as to view or adjust the pressure and temperature values that correspond to 4 and 20mA. Zero flow always corresponds to 4mA and full scale flow always corresponds to 20mA.

All values in the output menu have been calibrated and set at the factory. You only need to enter these screens if you wish to view, adjust, or test any of the values.

Full Scale Flow





The full scale value is the flow value that corresponds to 20mA on the flow; 4-20mA analog output. This value can be adjusted between 50-100% of the original factory calibration full scale value found on the data tag.

Full Scale Flow
100.00 SCFM

 Note that accuracy is still based on the original factory calibration full scale value.

 4mA for flow is always set to zero flow.

 Factory calibration full scale is calculated for the application using the meter sizing tool.
www.sierrainstruments.com/products/tools/innovamass_sizing.html

Press enter  and the units will begin flashing. As in previous examples, use the  buttons to enter the desired value, and the enter key  to save the value. This concludes our review of the Calibration Sub-Menu. Press the exit  climb back up to the main menu.



Setting Up: 4-20mA Outputs

We will set “Flow” 4-20mA to demonstrate this function. The same routines apply for setting up “Pressure” 4-20 mA and Temperature 4-20mA.



Flow 4mA : View, Adjust, Test

Navigate to the “Flow 4mA” screen in the Output (Sub Menu). Use Table 13 above for guidance. From this menu, press enter to get to the flow 4mA setup screen.

Flow 4mA
11373

This numeric value is the Digital to Analog Converter (DAC) value that produces 4mA on the analog flow output. In the example screen DAC is 11373. Press enter () and the units will begin flashing. Increasing this value will raise the 4mA output and decreasing this value will lower the 4mA output. Use the  buttons to enter the desired numeric value, and the enter key () to save the value.



Test it

You can then use the down  button to force/test flow 4mA output and hit the up  button to stop the force/test. It will flash testing until you stop the test. You can repeat this process, if desired, until you achieve the desired result.

Flow 4mA
11373 - Testing



Flow 20 mA : View, Adjust, Test

Navigate to the “Flow 20mA” screen in the Output (Sub Menu). Use Table 13 for guidance.

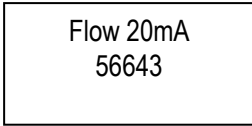
This value is the DAC value that produces 20 mA on the analog flow output. In the example screen DAC is 56643. Press enter  and the units will begin flashing. Increasing this value will raise the 20mA output and decreasing this value will lower the 20mA output. Use the  buttons to enter the desired numeric value, and then press the enter key  to save the value.



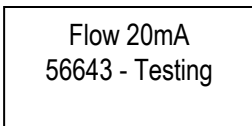

Test it

You can then use the down  button to force/test “Flow 20mA” output and hit the up  button to stop the force/test. It will flash testing until you stop the test. You can repeat this process, if desired, until you achieve the desired result.



	The engineering units are as set in the Calibration (Sub Menu). Go to that section for more detailed information.
--	---

In the example above, assume full scale flow is 100 scfm. As a result, a 20mA output equals 100 scfm and 4 mA output equals 0.00000 scfm. These values are fixed for flow. The output is linear between these two points, in this example, if we had a flow of 50 scfm, the output would be 12mA.

Once you have completed adjusting and testing the flow, pressure, and temperature 4-20mA DAC values press the right key  to reach the appropriate sub-menu and use the  buttons to enter the desired numeric value, and then press the enter key  to save the value.

Getting 4 to 20mA for Pressure and Temperature







If you have a V (flow volumetric only) or VT (flow volumetric and temperature only) unit, the P (pressure) and/or T (temperature) low and high will be set to meter defaults to 0 to 500 psig (0 to 34.47 barg) and Temp low and high to -40°F to 390°F (-40°C to 200°C) since those are the meter limits.

The pressure units above are the current pressure units you ordered or that you have changed in the process pressure and temperature sub-menu.

Pressure Outputs:

In the screen below pressure units are psia then 0.00 psia would correspond to the pressure 4mA output.







Pressure 4mA
0.00



Press enter key  and use the use the  buttons to enter the desired numeric value, and then press the enter key  to save the value.

Press the right  key to continue to the pressure value that corresponds to the 20mA output.

Pressure 20mA
30.00

In the example screen above, if your pressure units are psia then 30.00 psia would correspond to the pressure 20mA output.

Press enter key  and use the use the  buttons to enter the desired numeric value, and then press then press the enter key  to save the value.







	If you change this value, be sure not to enter a pressure for 20mA greater than the full scale of the pressure option you ordered or you would be over the range of the transducer.
	If you change these pressure “Low and High” 4-20mA values the pressure accuracy is still based on the original +/-1% of full scale of the pressure transducer option ordered.

Temperature Outputs:

Press the right  key to continue to the temperature value that corresponds to the 4mA output.

Temp. 4 mA
32.00





The temperature units above are the current temperature units you ordered or that you have changed in the calibration sub-menu. In the example above, if your temperature units are °F then 32.00°F would correspond to the temperature 4mA output.

Press enter key  and use the use the  buttons to enter the desired numeric value, and then press the enter key  to save the value.

Press the right  key to continue to the value that corresponds to the 20mA output.

Temp. 20 mA
212.00

In the example above, if your temperature units are °F then 212.00°F would correspond to the temperature 20mA output.

Press enter key  and use the   buttons to enter the desired numeric value, and then press the enter key  to save the value.

If you change these temperature low/high values the temperature accuracy is still based on the original +/-1°C specification.

In the above examples, from 32.00°F to 212.00°F or from 0 to 30 psia would correspond to the 4 and 20mA analog outputs for temperature and pressure. These values are dependent upon your process.

Reference Conditions (Sub-Menu): Standard and Normal

Use this menu to establish the reference conditions as specified in the units menu. Navigate to the Reference Conditions (Sub Menu). Use Table 14 for guidance. The display will look like this.

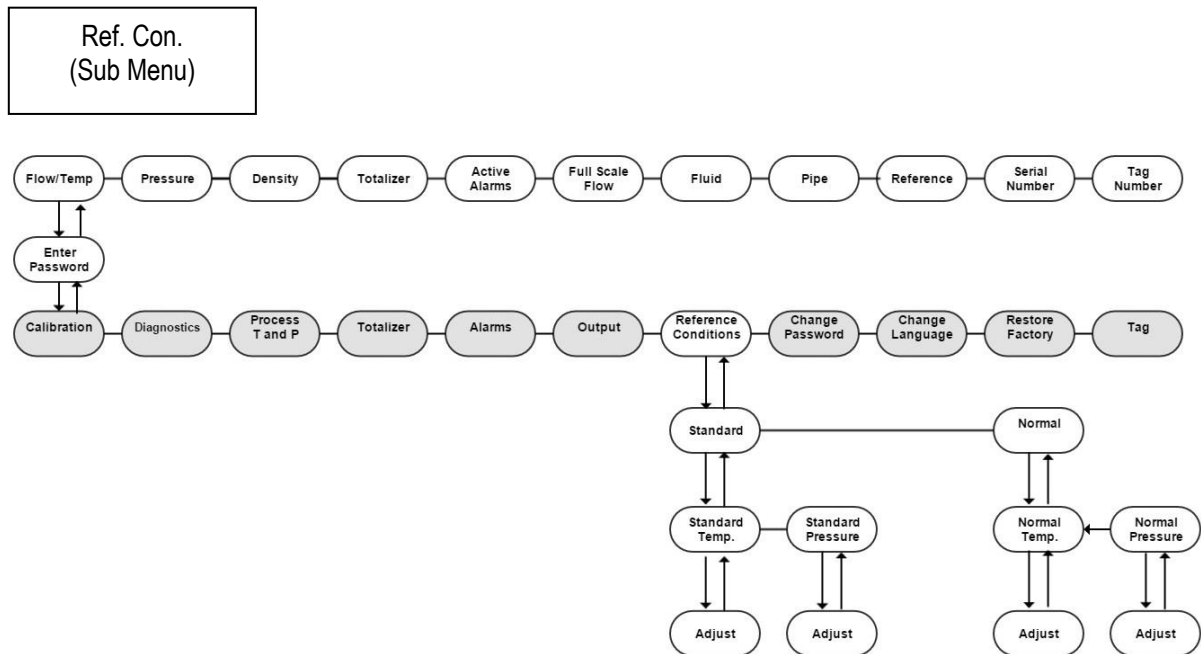

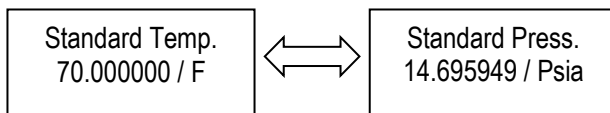

Table 14: Reference Conditions (Sub Menu)

Press enter  once and then use the   buttons to select “Standard” or “Normal”.







Once this has been selected you will press enter  again to see the screens below.

Use the   buttons to toggle between the two screens.





For example, scfm (Standard Cubic Feet per Minute) is commonly used in the United States. The S = Standard in scfm and is referenced to 70°F (21.1°C) and 14.696 Psia (or 1 atmosphere).

In Europe, Nm³/hr (Normal Cubic Meters per Hour) is commonly used. The N = Normal and is generally referenced to 0°C and 101.32 KPa A (or 1 atmosphere).

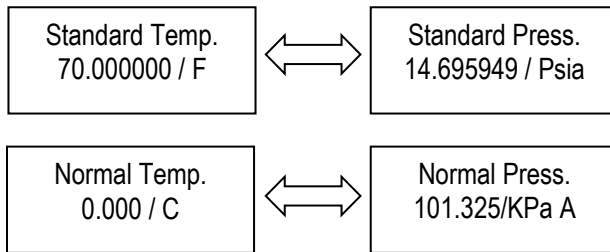





From here you can adjust instrument reference conditions . To adjust, press  again and the units will begin flashing. As in previous examples, use the  buttons to enter the desired value, and press enter  to save the value.



Once you are done press the enter key  to save. You can press the exit  several times to climb back up to the main menu level or press  to proceed to the next Sub-Menu called Diagnostics.



Change Password (Sub-Menu)

Use the Change Password (Sub-Menu) this menu to set or change a password. Navigate to the Change Password (Sub-Menu).

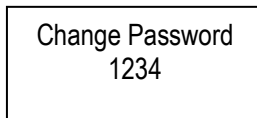
A password is required to access the set-up sub menus. Press enter  and the four digit password units will begin flashing. As in previous examples, use the  buttons to enter the desired value, and press enter  to save the value.





The default password is 0000. If you have lost your password and can't gain needed access to the setup screens, you can contact our service department for a password that would allow you to access the setup screens and setup a new password.

You can press the exit  several times to climb back up to the main menu level or press  to proceed to the next Sub-Menu called Change Language.

Change Language (Sub-Menu)

Navigate to the Change Language (Sub-Menu).

Use Change Language (Sub-Menu) to change the displayed language of the meter. Use the SIP program to download latest languages to your device. There are three language slots available.

You can press the exit  several times to climb back up to the main menu level or press  to proceed to the next Sub-Menu called Restore Factory.

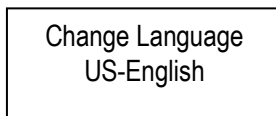





Restore Factory (Sub-Menu):



Use Restore Factory (Sub-Menu) to restore all parameters to the original factory conditions.

Important: This will undo any changes you have made.

Navigate to the Restore Factory (Sub-Menu). Use Table 2 for guidance.

Press enter  and the YES will begin flashing. As in previous examples, use the  buttons to enter YES or NO, and press the enter key  to save.





Restore Factory YES

You can press the exit  several times to climb back up to the main menu level or press  to proceed to the next Sub-Menu called Tag.

Tag (Sub-Menu):

Use Tag (Sub-Menu) to give the meter an alphanumeric tag name.

Navigate to the Tag (Sub-Menu). Use Table 2 for guidance.

Press enter , use the  buttons to enter numeric value, and press the enter key  to save.

Tag 001

You can press the exit  several times to climb back up to the main menu level.

Chapter 4: Troubleshooting & Repair

Troubleshooting the Flow Meter

Begin hardware troubleshooting by verifying the following facilities issues are correct (See below check list). These areas impact system operation and must be corrected prior to performing any flow meter inspections.

1. Verify the incoming power to the flow meter is present and of the correct voltage and polarity.
2. Check the flow meter wiring for correct connections as described in Chapter 2.
3. Verify the flow meter is installed with the correct number of upstream and downstream pipe diameters as shown on pages 12 to 13.
4. Verify the flow direction indicator is correctly aligned pointing downstream of flow.
5. Make sure there are no leaks in the line being measured.

After verifying the factors above, follow the troubleshooting procedures outlined below and on the next page. If you need to return the flow meter to the factory, see page 56 for return shipping instructions.

Problem	Possible Cause	Solution
Velocity Measurement is Erratic or Fluctuating	Very erratic or non-uniform flow	Follow installation requirements shown in Chapter 2
	Flow meter installed with less than required minimum pipe diameters upstream and downstream of the sensor	Follow installation requirements shown in Chapter 2
	Insertion sensor probe not mounted securely	Sensor probe must be mounted securely without vibration
	Sensor component broken	Return to factory for replacement
	Malfunction in system electronics	Return to factory for evaluation
	Ground loop	Check wiring, see Chapter 2
	Moisture present in gas flow	Install a water trap or filter upstream of the flow sensor
	Problem	Possible Cause
Velocity Measurement Seems Too High or Low	Sensor assembly not aligned correctly to flow	Correct alignment with the flow indicator pointing downstream in the direction of flow
	Sensor probe not inserted to the proper depth	Verify sensing point is located on the centerline of the pipe
Problem	Possible Cause	Solution
No Response to Flow From	No power	Turn on power to the flow meter

Sensor Assembly	Meter Settings Incorrect	Correct meter settings programming using the Smart Interface software
	Flow rate below meter's minimum flow rating	Contact factory for instructions
	Flow has exceeded the maximum range of the flow meter	Set the user full scale to equal the factory full scale
		Reduce flow below the maximum range shown on the meter's nameplate or contact the factory for re-calibration advice
	Flow profile distortions	Try to find another location for the meter
	Extremely turbulent flow	Do not place the meter near a ventilator static mixer or valve
	Sensor failure	Return to factory for evaluation
	Printed circuit assembly defective	Return to factory for evaluation

Returning Equipment to Factory

Factory Calibration—All Models

Sierra Instruments maintains a fully-equipped calibration laboratory. All measuring and test equipment used in the calibration of Sierra transducers are traceable to NIST Standards. Sierra is ISO-9001 registered and conforms to the requirements of ANSI/NCSL-Z540 and ISO/IEC Guide 25.

Instructions for Returning Your Instrument for Service

The following information will help you return your instrument to Sierra Instruments' Factory Service Center and will ensure that your order is processed promptly. Prices may vary depending on the flow range, type of gas and operating pressure of your unit. To request detailed pricing, contact your local Sierra Instruments distributor or contact one of our offices directly.

Please follow these easy steps to return your instrument for factory service:

1. To obtain a Return Materials Authorization (RMA) go to:
www.sierrainstruments.com/rma/new.php to create a Sierra Account.
2. Once you have created an account, click on the Submit New RMA tab and fill in the RMA form and follow the instructions. You will receive an email confirmation once you have submitted your RMA.
3. Print a copy of the RMA (that now includes RMA #) and send a copy of the RMA form along with your meter back to the factory.

If you require service beyond calibration, but do not know which service(s) will be required, describe the symptoms as accurately as possible on the RMA form.

Pack your instrument carefully. Use the original packaging and foam or bubble wrap (packing peanuts NOT recommended) and include a copy of the RMA form (complete with Sierra supplied RMA number) with the unit(s).

Ship the unit(s) to the following address:

**Sierra Instruments, Inc.
Attention: Factory Service Center
5 Harris Court, Building L
Monterey, CA 93940 USA
RE: RMA# (your number)**

**For Global Service Centers, go to
<http://www.sierrainstruments.com/facilities.html>**

Appendix A: Product Specifications

PERFORMANCE SPECIFICATIONS

Fluid Measured

Mass or volumetric flow measurement of any gas, liquid, or steam
 Dial-A-Fluid feature to change fluid in the field
 Fluid Database to build complex fluid mixtures with qMix software

Multivariable Outputs

Measure five process variables with one process connection:
 Mass flow rate, volumetric flow rate, density, pressure, and temperature
 Totalized flow based on user-determined flow units, sixteen full digits

Accuracy

Process Variables	240i Inline Meters		241i Insertion ⁽¹⁾ Meters	
	Liquids	Gas and Steam	Liquids	Gas and Steam
Mass Flow Rate	+/- 1.0% of reading over a 30:1 range ⁽³⁾	+/- 1.5% of reading ⁽²⁾ over a 30:1 range ⁽³⁾	+/- 1.2% of reading over a 30:1 range ⁽³⁾	+/- 2.0% of reading ⁽²⁾ over a 30:1 range ⁽³⁾
Volumetric Flow Rate	+/- 0.7% of reading over a 30:1 range ⁽³⁾	+/- 1.0% of reading over a 30:1 range ⁽³⁾	+/- 1.0% of reading over a 30:1 range ⁽³⁾	+/- 1.5% of reading over a 30:1 range ⁽³⁾
Temperature	+/- 2°F (+/- 1°C)	+/- 2°F (+/- 1°C)	+/- 2°F (+/- 1°C)	+/- 2°F (+/- 1°C)
Pressure	0.5% of transducer full scale	0.5% of transducer full scale	0.5% of transducer full scale	0.5% of transducer full scale
Density	0.3% of reading	1.0% of reading ⁽²⁾	0.3% of reading	1.0% of reading ⁽²⁾

Notes: (1) Accuracies stated are for the total mass flow through the pipe.
 (2) Over 50% to 100% of the pressure transducer's full scale.
 (3) Nominal rangeability is stated. Precise rangeability depends on fluid and pipe size.

Repeatability

Mass Flow Rate: +/- 0.2% of reading
 Volumetric Flow Rate: +/- 0.1% of reading
 Temperature: +/- 0.2°F (+/- 0.1°C)
 Pressure: +/- 0.05% of full scale
 Density: +/- 0.1 % of reading

Stability Over 12 Months

Mass Flow Rate: +/- 0.2% of reading maximum
 Volumetric Flow Rate negligible error
 Temperature: +/- 1.0°F (+/- 0.5°C) maximum
 Pressure: +/- 0.1% of full scale maximum
 Density: +/- 0.1% of reading maximum

Differential Pressure Requirements, P

Permanent pressure loss of inline meters for air at 68°F (20°C) and 14.70 psi (1.104 bara). See Figure 1. Permanent pressure loss of inline meters for water at 68°F (20°C). See Figure 2.

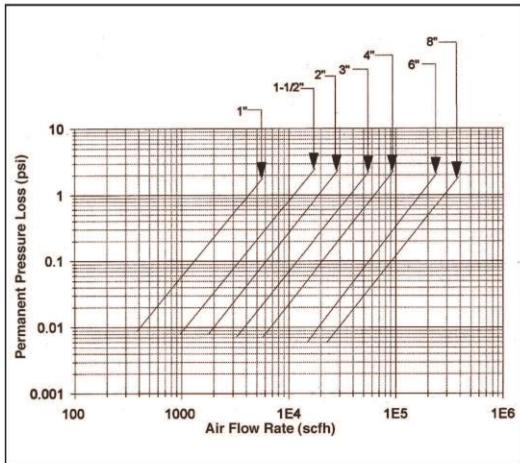

Figure 1

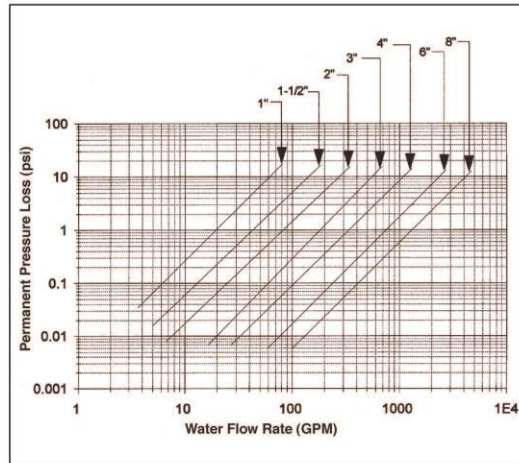

Figure 2

PERFORMANCE SPECIFICATIONS (continued)

Material Compatibility

240i: Any gas, liquid or steam compatible with 316L stainless steel. Not recommended for multi-phase fluids.

241i: Any gas, liquid or steam compatible with 316L stainless steel. Not recommended for multi-phase fluids.

Note: Units with the pressure option use Viton® elastomers.

Linear Range

Smart electronics corrects for lower flow, down to a Reynolds number of 2,000. The Reynolds number is calculated using the fluid's actual temperature and pressure monitored by the meter. Rangeability depends on the fluid, process connections and pipe size (consult factory with your application). Velocity rangeability under ideal conditions is as follows:

Liquids 30:1

Minimum Velocity

1 foot per second
(0.3 meters per second)

Maximum Velocity

30 feet per second
(9.14 meters per second)

Gases 30:1

Minimum Velocity

$$\sqrt{\frac{25}{\rho}} \text{ ft/s } \rho \text{ in lb}_m/\text{ft}^3$$

$$\sqrt{\frac{37}{\rho}} \text{ m/s } \rho \text{ in kg/m}^3$$

where ρ = fluid density

Maximum Velocity

91 m/s velocity
300 ft/s velocity

OPERATING SPECIFICATIONS

Flow Rates

Typical mass flow ranges are given in the following table. Precise flow ranges depend on the fluid and pipe size. 241i insertion meters are applicable to pipe sizes from 2 inches (DN50) and greater. Consult factory for sizing program:

www.sierrainstruments.com/products/innovamass_sizing.html

Water Minimum and Maximum Flow Rates (gpm)								
Unit	1-inch	1.5-inch	2-inch	3-inch	4-inch	6-inch	8-inch	
gpm	Min	2.3	5.5	9.2	21	36	81	143
	Max	68	165	276	618	1080	2440	4280

Water Minimum and Maximum Flow Rates (m ³ /hr)								
Unit	DN25	DN40	DN50	DN80	DN100	DN150	DN200	
m ³ /hr	Min	0.5	1.3	2.1	4.7	8.2	18	32
	Max	15	38	63	140	245	553	971

Air Minimum and Maximum Flow Rates (scfm) ⁽¹⁾								
Pressure	1-inch	1.5-inch	2-inch	3-inch	4-inch	6-inch	8-inch	
0 psig	Min	5.52	13.5	22.5	50.4	87.8	199	349
	Max	90.5	221	369	826	1440	3260	5720
100 psig	Min	15.1	36.9	61.8	138	241	545	956
	Max	694	1690	2830	6330	11000	25000	43800
200 psig	Min	20.7	50.4	84.3	188	329	743	1300
	Max	1300	3170	5300	11800	20600	46700	81900
300 psig	Min	25	61	102	228	397	899	1580
	Max	1900	4640	7760	17300	30200	68400	120000
400 psig	Min	28.6	69.9	117	261	456	1030	1810
	Max	2500	6110	10200	22800	39800	90100	158000
500 psig	Min	31.9	77.8	130	291	507	1150	2010
	Max	3110	7580	12700	28300	49400	112000	196000

Note: (1) Standard conditions are 70° F and 1 atmosphere (21.1°C and 760 Torr).

Air Minimum and Maximum Flow Rates (nm ³ /hr) ⁽¹⁾								
Pressure	DN25	DN40	DN50	DN80	DN100	DN150	DN200	
0 barg	Min	9.35	22.8	38.2	85.3	149	337	591
	Max	154	375	628	1400	2450	5530	9710
5 barg	Min	22.8	55.6	92.9	208	362	819	1440
	Max	912	2230	3730	8330	14500	32800	57600
10 barg	Min	28.2	68.7	115	257	448	1010	1780
	Max	1530	3750	6270	14000	24400	55200	96900
20 barg	Min	42.5	104	173	387	676	1530	2680
	Max	3190	7780	13000	29100	50700	115000	201000
30 barg	Min	51.5	126	210	470	820	1850	3250
	Max	4710	11500	19200	42900	74900	169000	297000
40 barg	Min	59.2	145	242	540	942	2130	3740
	Max	6220	15200	25400	56800	99000	224000	393000

Note: (1) Normal conditions are 32°F and 1 atmosphere (0°C and 760 Torr).

OPERATING SPECIFICATIONS (continued)

Saturated Steam Minimum and Maximum Flow Rates (lb/hr)								
Pressure		1-inch	1.5-inch	2-inch	3-inch	4-inch	6-inch	8-inch
5 psig	Min	20	48.9	81.8	183	319	721	1270
	Max	266	650	1090	2430	4240	9590	16800
100 psig	Min	45.9	112	187	418	730	1650	2900
	Max	1390	3400	5690	12700	22200	50200	88100
200 psig	Min	61.9	151	253	565	985	2230	3910
	Max	2540	6200	10400	23200	40400	91400	160000
300 psig	Min	74.6	182	304	680	1190	2680	4710
	Max	3690	9000	15100	33600	58700	133000	233000
400 psig	Min	85.5	209	349	780	1360	3080	5400
	Max	4840	11800	19800	44200	77100	174000	306000
500 psig	Min	95.3	233	389	870	1520	3430	6020
	Max	6020	14700	24600	55000	95900	217000	381000

Saturated Steam Minimum and Maximum Flow Rates (kg/hr)								
Pressure		DN25	DN40	DN50	DN80	DN100	DN150	DN200
0.5 barg	Min	11	26.8	44.8	100	175	395	693
	Max	134	326	546	1220	2130	4810	8440
5 barg	Min	18.2	44.5	74.4	166	290	656	1150
	Max	488	1190	1990	4450	7770	17600	30800
10 barg	Min	24.3	59.3	99.2	222	387	874	1530
	Max	867	2120	3540	7910	13800	31200	54800
20 barg	Min	33.2	81.1	136	303	528	1200	2100
	Max	1620	3960	6620	14800	25800	58300	102000
30 barg	Min	40.3	98.3	164	368	641	1450	2540
	Max	2380	5820	9740	21800	37900	85800	151000
40 barg	Min	46.4	113	190	424	739	1670	2930
	Max	3170	7740	12900	28900	50400	114000	200000

OPERATING SPECIFICATIONS (continued)

Process Fluid Pressure

241i Insertion Pressure Ratings				
Probe Seal	Process Connection	Material	Rating	Ordering Code
Compression Fitting	2-inch male NPT	316L SS	500 psig (34.5 barg)	CM
	2-inch 150 lb flange	316L SS	ANSI 150 lb	CF
	2-inch 300 lb flange	316L SS	ANSI 300 lb	CG
	2-inch 600 lb flange	316L SS	ANSI 600 lb	CH
	DN50/PN16 flange	316L SS	PN16	CFD
	DN50/PN40 flange	316L SS	PN40	CGD
	DN50/PN64 flange	316L SS	PN64	CHD
Packing Gland	2-inch male NPT	316L SS	500 psig (34.5 barg)	PM
	2-inch 150 lb flange	316L SS	ANSI 150 lb	PF
	2-inch 300 lb flange	316L SS	ANSI 300 lb	PG
	2-inch 600 lb flange	316L SS	ANSI 600 lb	PH
	DN50/PN16 flange	316L SS	PN16	PFD
	DN50 PN40 flange	316L SS	PN40	PGD
	DN50 PN64 flange	316L SS	PN64	PHD

Process Fluid Pressure

240i Inline Pressure Ratings		
Process Connection	Material	Rating
Flanged	316L SS	150, 300, 600 lb
DN Flanged	316L SS	PN16, PN40, PN64

Pressure Transducer Ranges

Pressure Sensor Ranges ⁽¹⁾ psia (bara) Full Scale Operating Pressure (FS)	
psia	(bara)
15 to 30 [FS 30]	1.0 to 2.1 [FS 2.1]
30 to 100 [FS 100]	2.1 to 6.9 [FS 6.9]
100 to 300 [FS 300]	6.9 to 20.7 [FS 20.7]
300 to 500 [FS 500]	20.7 to 34.5 [FS 34.5]

Note: (1) To maximize accuracy, specify the lowest full scale operating pressure range for the application. To avoid damage, the flow meter must never be subjected to "Full Scale Operating Pressure" shown above.

Process Fluid & Ambient Temperature

Standard Temperature Sensor: -40°F to 392°F
(-40°C to 200°C)

Ambient Operating:

- NAA/cFMus: -40°F to 140°F (-40°C to 60°C)
- ATEX/IECEX: -4°F to 140°F (-20°C to 60°C)
- Storage: -40°F to 150°F (-40°C to 65°C)
- 0-98% relative humidity, non-condensing conditions

PHYSICAL SPECIFICATIONS

Wetted Materials

240i: 316L stainless steel standard
Viton® O-ring used on pressure transducer

241i: 316L stainless steel standard
Viton® packing gland
Other packing gland materials available upon request
Viton® O-ring used on pressure transducer

Enclosure

NEMA 4x (IP66) cast enclosure

Electrical Ports

Two 3/4-inch female NPT conduit ports

Mounting Connections

240i: 150, 300, 600 lb ANSI flange; PN16, 40, 64 DN flanges

241i: Permanent Installation
Two-inch male NPT; 150, 300, 600 lb ANSI flange (PN16, 40, 64 DN flanges) with compression fitting probe seal

Hot Tap Installation:

Two-inch male NPT; 150, 300, 600 lb ANSI flange (PN16, 40, 64 DN flanges); and optional retractor with packing gland probe seal, removable under line pressure.

Mounting Position

240i: No effect

241i: Meter must be perpendicular within +/- 5° of the pipe centerline

PHYSICAL SPECIFICATIONS (continued)

Approvals

cFMus Approval
ATEX Approval
IECEX Approval
CE Approval

Optional Certifications

Construction and inspection (ANSI/ASME B31.3)
Materials (NACE MR-01-75(90))

Alarms⁽¹⁾

Solid-state relay for high, low or window alarms
Contact SPST / optical relay

POWER REQUIREMENTS

24 VDC +/-10%, 0.4 amp maximum
100 to 240 VAC, 50/60 Hz, 0.2 amps RMS at 12 W maximum

ANALOG AND DIGITAL OUTPUTS

Output Signals

Analog

Three field rangeable, simultaneous linear 4-20 mA output signals (500 ohms maximum loop resistance) for mass or volumetric flow rate, temperature, and pressure.

Pulse⁽¹⁾

Relay capable of 1 Hz maximum user-definable pulse output for totalized flow

Note: (1) The pulse and alarm outputs are optically isolated and require external power for operation.

Digital Communications

HART, Modbus, RS-232, USB, Profibus DP and Foundation Fieldbus

USER INTERFACE & SOFTWARE

Smart Interface Portal (SIP)

User-centered software program allows for easy configuration and field validation. Includes:

Meter Tune: Adjusts inputs and outputs to adjust to application
ValidCal Diagnostics: Automatically diagnoses firmware and hardware and reports faults

User Interface

Local, keypad with six-button interface
Exit \otimes , and Enter \leftarrow , with four-way directional arrows
RS-232 with PC software for communication and programming

Display

Ultra-bright, backlit, LCD digital display, 2 x 32 scrolling

Multi-Language

Supports English, Spanish, German and Mandarin; user can also add languages

Field Adjustments

Change between engineering units, fluid, pipe size, language

SIZING PROGRAM

Easy, web-based sizing program to input application details and generate correct meter specification. The sizing program is also available through the Smart Interface Portal if an internet connection is not available.

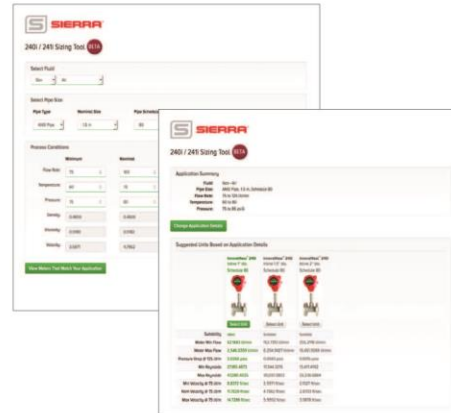

Visit www.sierrainstruments.com/products/innovamass_sizing.html for more information on the sizing program.

CALIBRATION

High-Performance Calibration Facility

High-accuracy flow calibration, used according to ASME standards.

Max Flow: 143m³/h (.5in – 4in capabilities)

Pressure: Ambient

Temperature: Ambient

Liquid: Water

Uncertainty: 0.2% of the measured reading
0.1% repeatability

Control: Cadet V14 Test Automation Software

Data Collection: High speed data acquisition
hardware and software

Calibration Interval: Annual (verified daily)



240i INLINE DIMENSIONAL DRAWINGS

240i Flanged Inline—Front

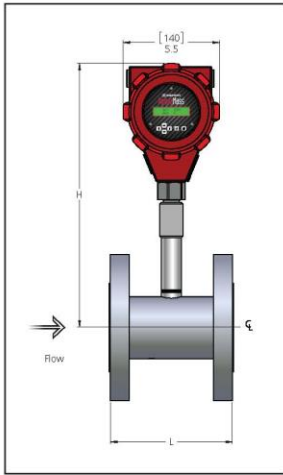

240i Flanged Inline—Side (Outlet View)

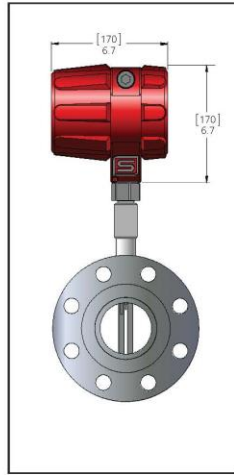

240i Remote Inline Junction Box—Front

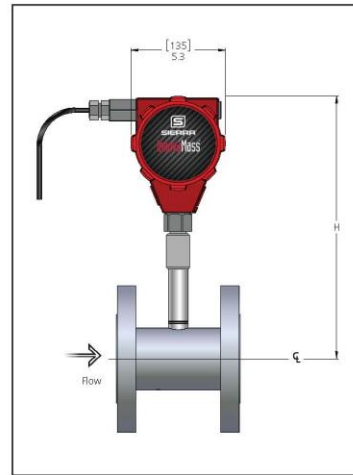

240i Remote Inline Junction Box—Side (Outlet View)

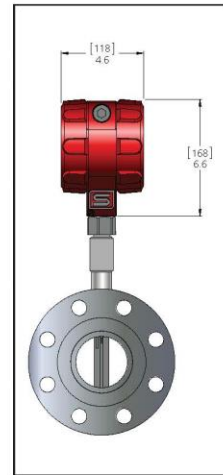

Note: All dimensions are inches (+/- .25-inch significant value). Millimeters are in parentheses. Certified drawings are available on request.

240i Inline Flange Sizes SCH 80 Pipe, 150, 300 Flanges		
Flow Body Size	L	H
1-inch	5.00 (127)	15.0 (381)
1.5-inch	5.50 (140)	15.1 (384)
2-inch	6.00 (152)	15.3 (389)
3-inch	7.00 (178)	15.8 (401)
4-inch	8.00 (203)	16.2 (411)
6-inch	9.00 (229)	17.3 (439)
8-inch	10.50 (267)	18.2 (462)

Note: All dimensions are inches (+/- .25-inch significant value). Millimeters are in parentheses. Certified drawings are available on request. 600 lb and PN64 meters have different L dimensions. Please contact Sierra for dimensions.

240i Inline Flange Sizes PN16, 40		
Flow Body Size	L	H
DN25	5.00 (127)	15.0 (381)
DN40	5.50 (140)	15.1 (384)
DN50	6.00 (152)	15.3 (389)
DN80	7.00 (178)	15.8 (401)
DN100	8.00 (203)	16.2 (411)
DN150	9.00 (229)	17.3 (439)
DN200	10.50 (267)	18.2 (462)

Note: All dimensions are inches (+/- .25-inch significant value). Millimeters are in parentheses. Certified drawings are available on request. 600 lb and PN64 meters have different L dimensions. Please contact Sierra for dimensions.

241i INSERTION SIZE OPTIONS

241i Variable Probe Dimensions			
241i Probe Type	Ordering Code	Meter Length (A)	Probe Length (B)
Standard Probe	LS	41.5 (1054.1)	33.5 (850.9)
Compact Probe	LC	24.5 (622.3)	16.5 (419.1)

Note: For these cFmus and ATEX/IECEx approval types add killark seal dimension to dimension A (6.2-inches; 157 mm).

241i Process Connection Variable Dimensions			
241i Connection Options	Ordering Code	Process Connection Width (X)	Process Connection Height (Y)
Compression Fitting 2-inch NPT	CM	2.8 (72.2)	2.7 (68.6)
Compression Fitting 2-inch 150 lb flange	CF	6.0 (152.4)	2.3 (58.4)
Compression Fitting 2-inch 300 lb flange	CG	6.5 (165.1)	2.4 (61.0)
Compression Fitting 2-inch 600 lb flange	CH	6.5 (165.1)	2.5 (63.5)
Packing Gland 2-inch NPT	PM	2.5 (63.5)	7.0 (177.8)
Packing Gland 2-inch 150 lb flange	PF	6.0 (152.4)	7.3 (185.4)
Packing Gland 2-inch 300 lb flange	PG	6.5 (165.1)	6.5 (165.1)
Packing Gland 2-inch 600 lb flange	PH	6.5 (165.1)	7.5 (190.5)

Note: Dimensions are measured from the center of the flow tube. For DN equivalent process connections use the same dimensions.

241i INSERTION DIMENSIONAL DRAWINGS

Note: Reference 241i Variable Probe Dimensions on page 13 to see length dimensions for A and B.

Overall Dimensions

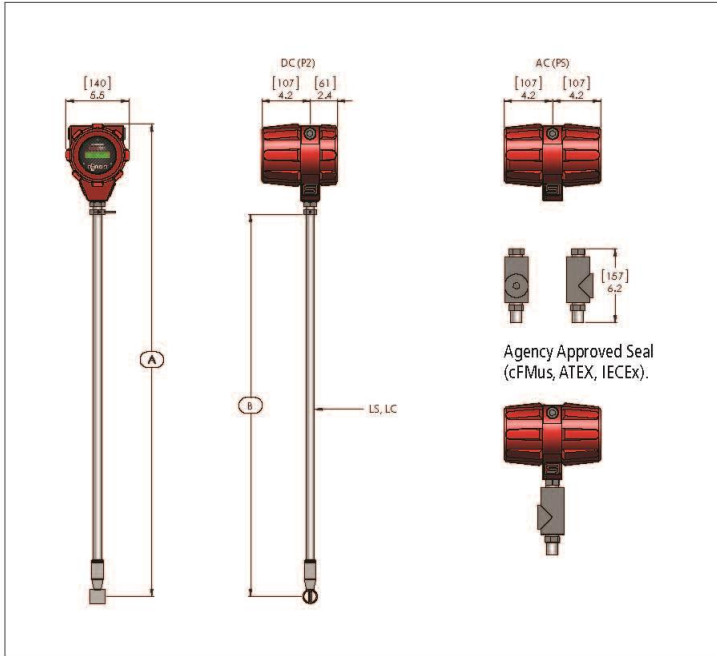

Flange and Compression Fittings

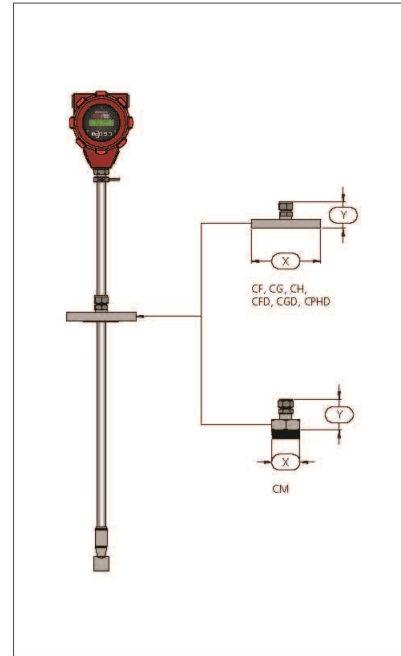

Note: Killark seal adds 6.2 inches (157 mm) to total meter length for agency approval devices.

Packing Glands

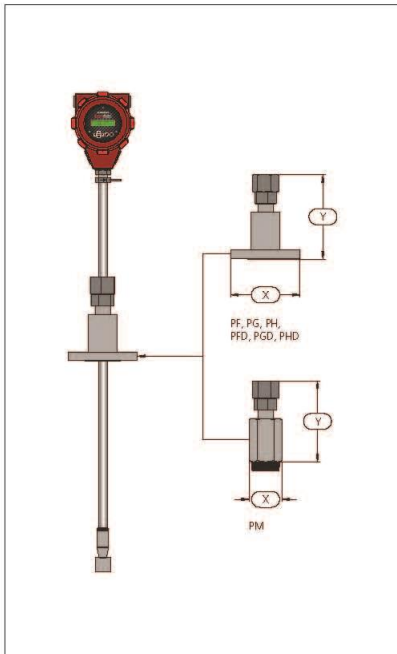

Adjustable, Rotatable & Removable Sensor Probe Retractor System

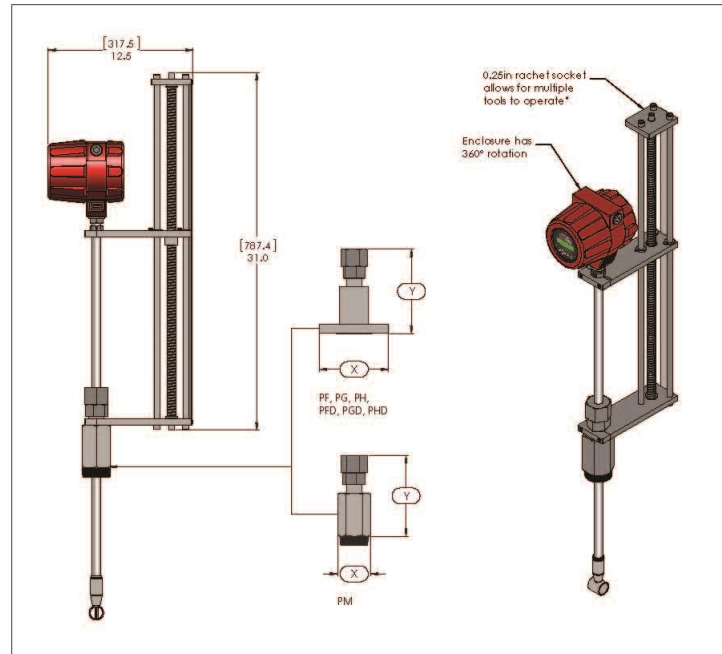

Note: All dimensions are inches (+/- .25-inch significant value). Millimeters are in parentheses. Certified drawings are available on request.

ADDITIONAL DIMENSIONAL DRAWINGS

Remote Electronics—Front
(Inline and Insertion Versions)



Remote Electronics—Side
(Inline and Insertion Versions)

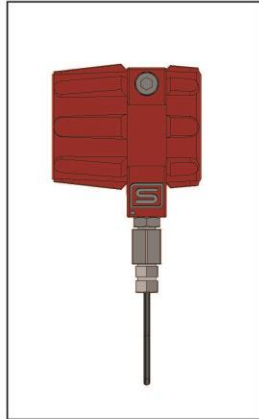

Remote Electronics with
Bracket—Front (Inline and
Insertion Versions)

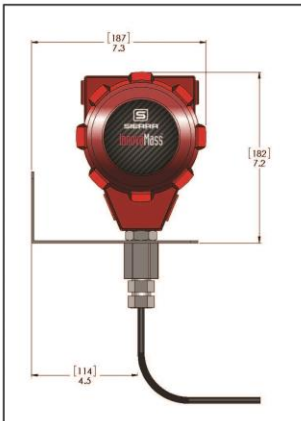

Remote Electronics with
Bracket—Side (Inline and
Insertion Versions)

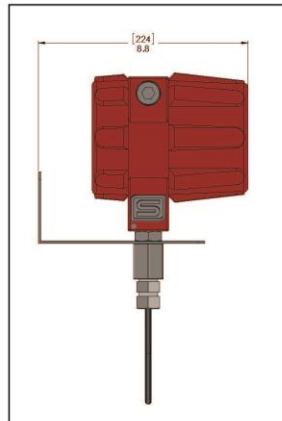

Bracket—Size and Mounting

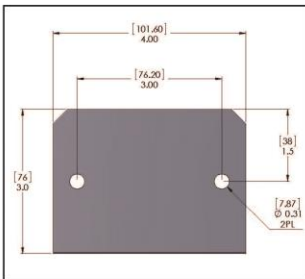

All dimensions are inches (+/- .25-inch significant value). Millimeters are in parentheses. Certified drawings are available on request.

Straight Pipe Length Requirements (in number of internal diameters, D)

Upstream Plumbing	Upstream	Downstream
One 90° elbow before meter	10 D	5 D
Two 90° elbows before meter	15 D	5 D
Two 90° elbows before meter out of plane (If three 90° bends present, double recommend length)	25 D	10 D
Reduction before meter	20 D	5 D
Expansion before meter	25 D	10 D

240i Inline Meter Weight

Connection Size	ANSI 150 lb		ANSI 300 lb		ANSI 600 lb	
	lb	kg	lb	kg	lb	kg
1-inch Flange	13.5	6.1	16.4	7.4	16.4	7.4
1.5-inch Flange	14.6	6.6	22.7	10.3	24.0	11.2
2-inch Flange	19.5	8.8	26.9	12.2	33.2	15.1
3-inch Flange	27.5	12.5	39.5	17.9	56.3	25.3
4-inch Flange	43.5	19.7	60.5	27.4	96.2	43.6
6-inch Flange	48.4	22.0	96.2	43.6	178	80.8
8-inch Flange	71.0	32.2	149	67.4	300	136

241i Insertion Meter Weight

Connection Size	lb	kg
Compression Fitting, Male NPT	16.4	7.4
1.5-inch Flange	22.7	10.3
Compression Fitting, 150 lb Flange	26.9	12.2
Compression Fitting, 300 lb Flange	39.5	17.9
Packing Gland, Male NPT	60.5	27.4
Packing Gland, 150 lb Flange	10.4	4.7
Packing Gland, 300 lb Flange	24.8	11.3
Packing Gland, 600 lb Flange	26.8	12.2

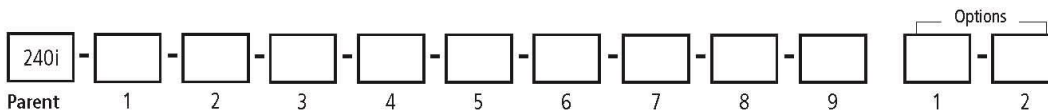

Instructions: To order a 240i, please fill in each number block by selecting the codes from the corresponding features below and following pages.

Parent Model Number	
240i	InnovaMass® iSeries Inline Vortex Flow Meter Raptor II OS

Feature 1: Multivariable Options	
V	Volumetric flow meter for liquid, gas and steam
VT	Velocity and temperature sensors; mass measurement with temperature compensation
VTP	Velocity, temperature and pressure sensors; mass measurement with pressure and temperature compensation

Feature 2: Approvals	
1	NAA. Non-agency approved.
2	cFMus. Process Temperature Range: -40°C to 200°C (-40°F to 392°F); Class I, Division 1, Groups B,C, and D, T6; Ta = -40°C to 60°C (-40°F to 140°F). Type 4x.
3	ATEX and IECEx. Process Temperature Range: -40°C to 200°C (-40°F to 392°F). ATEX: II 2 G Ex db IIC T3 Gb Ta = -20°C to +60°C (-4°F to 140°F), IP66 II 2 D Ex tb IIIC T200°C Db Ta = -20°C to +60°C (-4°F to 140°F), IP66 IECEx: Ex db IIC T3 Gb Ta = -20°C to +60°C (-4°F to 140°F), IP66 Ex tb IIIC T200°C Db Ta = -20°C to +60°C (-4°F to 140°F), IP66

Feature 3: Flow Body (ANSI 316L)					
F4	1-inch ANSI class 150 lb flanged, 316L	G4	1-inch ANSI class 300 lb flanged, 316L	H4	1-inch ANSI class 600 lb flanged, 316L
F5	1.5-inch ANSI class 150 lb flanged, 316L	G5	1.5-inch ANSI class 300 lb flanged, 316L	H5	1.5-inch ANSI class 600 lb flanged, 316L
F6	2-inch ANSI class 150 lb flanged, 316L	G6	2-inch ANSI class 300 lb flanged, 316L	H6	2-inch ANSI class 600 lb flanged, 316L
F7	3-inch ANSI class 150 lb flanged, 316L	G7	3-inch ANSI class 300 lb flanged, 316L	H7	3-inch ANSI class 600 lb flanged, 316L
F8	4-inch ANSI class 150 lb flanged, 316L	G8	4-inch ANSI class 300 lb flanged, 316L	H8	4-inch ANSI class 600 lb flanged, 316L
F9	6-inch ANSI class 150 lb flanged, 316L	G9	6-inch ANSI class 300 lb flanged, 316L	H9	6-inch ANSI class 600 lb flanged, 316L
F10	8-inch ANSI class 150 lb flanged, 316L	G10	8-inch ANSI class 300 lb flanged, 316L	H10	8-inch ANSI class 600 lb flanged, 316L

Feature 3: Flow Body (DN 316L)					
FD4	DN25/PN16 flanged, 316L	GD4	DN25/PN40 flanged, 316L	HD4	DN25/PN64 flanged, 316L
FD5	DN40/PN16 flanged, 316L	GD5	DN40/PN40 flanged, 316L	HD5	DN40/PN64 flanged, 316L
FD6	DN50/PN16 flanged, 316L	GD6	DN50/PN40 flanged, 316L	HD6	DN50/PN64 flanged, 316L
FD7	DN80/PN16 flanged, 316L	GD7	DN80/PN40 flanged, 316L	HD7	DN80/PN64 flanged, 316L
FD8	DN100/PN16 flanged, 316L	GD8	DN100/PN40 flanged, 316L	HD8	DN100/PN64 flanged, 316L
FD9	DN150/PN16 flanged, 316L	GD9	DN150/PN40 flanged, 316L	HD9	DN150/PN64 flanged, 316L
FD10	DN200/PN16 flanged, 316L	GD10	DN200/PN40 flanged, 316L	HD10	DN200/PN64 flanged, 316L

Feature 4: Electronics Enclosure	
E2	NEMA 4X IP 66 enclosure
E4()	NEMA 4X IP 66 remote electronics on probe: specify cable length in parentheses, maximum 50 feet (15.24 m) includes cable glands

Feature 5: Display Option	
DD	Digital display with push buttons
NR	No readout/display

Feature 6: Input Power	
P2	24 VDC +/- 10% 0.4 amps, 12 watts maximum
PS	100-240 VAC, 50/60 Hz line power, 12 watts maximum

Feature 7: Output	
V6	Three analog outputs (4-20 mA), one alarm, one pulse
V6H	Three analog outputs (4-20 mA), one alarm, one pulse, HART
V6M	Three analog outputs (4-20 mA), one alarm, one pulse, Modbus
V6DP1	Three analog outputs (4-20 mA), one alarm, one pulse, Profibus DP with external M12 connection. Not available with AC power; Available only NAA
V6DP2	Three analog outputs (4-20 mA), one alarm, one pulse, Profibus DP with terminal block connection. Not available with AC power
V6FF	Three analog outputs (4-20 mA), one alarm, one pulse, Foundation Fieldbus with terminal block connections

Note: AC power (Feature 6) not available with V6DP1, V6DP2

Feature 8: Process Temperature	
ST	Standard process temperature -40°F to 392°F (-40°C to 200°C)

Feature 9: Process Pressure	
MP0	No pressure sensor; used with V and VT option
MP1	Maximum 30 psia (2.1 bara), proof 60 psia (4.1 bara)
MP2	Maximum 100 psia (6.9 bara), proof 200 psia (13.8 bara)
MP3	Maximum 300 psia (20.7 bara), proof 600 psia (41.4 bara)
MP4	Maximum 500 psia (34.5 bara), proof 1000 psia (69.0 bara)

Option 1: Certificates	
MC	Material certificates—US Mill certs on all wetted parts
PT	Pressure test certificate
CC	Certificate of conformance
NC	NACE certification

Option 2: Oxygen Cleaning	
O2C	Cleaned for O2 service (includes certification). Meter must include O2 cleaning, if meter is to be used for oxygen service.

Accessories: Manuals	
240i-IM	Additional Instruction Manual

ORDERING THE 241i INSERTION

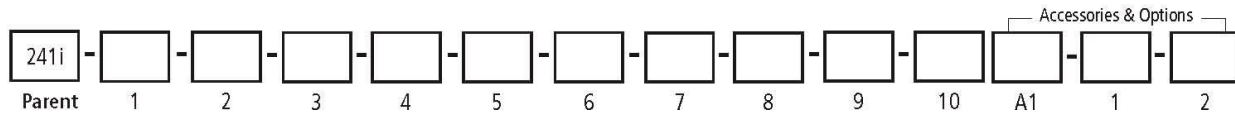

Instructions: To order a 241i, please fill in each number block by selecting the codes from the corresponding features below and following pages.

Parent Model Number	
241i	InnovaMass® iSeries Insertion Vortex Flow Meter Raptor II OS FloPro

Feature 1: Multivariable Options	
V	Volumetric flow meter for liquid, gas and steam
VT	Velocity and temperature sensors; mass measurement with temperature compensation
VTP	Velocity, temperature and pressure sensors; mass measurement with pressure and temperature compensation and automatic flow profile compensation by calculating the Reynolds Number

Feature 2: Approvals	
1	NAA. Non-agency approved.
2	cFMus. Process Temperature Range: -40°C to 200°C (-40°F to 392°F); Class I, Division 1, Groups B,C, and D, T6; Ta = -40°C to 60°C (-40°F to 140°F). Type 4x.
3	ATEX and IECEx. Process Temperature Range: -40°C to 200°C (-40°F to 392°F). ATEX: II 2 G Ex db IIC T3 Gb Ta = -20°C to +60°C (-4°F to 140°F), IP66 II 2 D Ex tb IIIC T200°C Db Ta = -20°C to +60°C (-4°F to 140°F), IP66 IECEX : Ex db IIC T3 Gb Ta = -20°C to +60°C (-4°F to 140°F), IP66 Ex tb IIIC T200°C Db Ta = -20°C to +60°C (-4°F to 140°F), IP66

Feature 3: Probe Length	
LS	Standard probe
LC	Compact probe available only for connections CM, CF, CG, CH
LE	Extended probe (consult factory if for PMR, PFR, PGR or PHR)

Feature 4: Electronics Enclosure	
E2	NEMA 4X IP 66 enclosure mounted on probe
E4()	Remote electronics NEMA 4X IP 66; specify cable length in parentheses, maximum 50 feet (15.24 m)

Feature 5: Display Option	
DD	Digital display with push buttons
NR	No readout/display

Feature 6: Input Power	
P2	24 VDC +/- 10% 0.4 amps, 12 watts maximum
PS	100-240 VAC, 50/60 Hz line power, 12 watts maximum

Feature 7: Output	
V6	Three analog outputs (4-20 mA), one alarm, one pulse
V6H	Three analog outputs (4-20 mA), one alarm, one pulse, HART
V6M	Three analog outputs (4-20 mA), one alarm, one pulse, Modbus
V6DP1	Three analog outputs (4-20 mA), one alarm, one pulse, Profibus DP with external M12 connection. Not available with AC power; Available only NAA
V6DP2	Three analog outputs (4-20 mA), one alarm, one pulse, Profibus DP with terminal block connection. Not available with AC power
V6FF	Three analog outputs (4-20 mA), one alarm, one pulse, Foundation Fieldbus with terminal block connections

Feature 8: Process Temperature	
ST	Standard process temperature -40°F to 392°F (-40°C to 200°C)

Feature 9: Process Pressure	
MP0	No pressure sensor: used with V and VT option
MP1	Maximum 30 psia (2.1 bara), proof 60 psia (4.1 bara)
MP2	Maximum 100 psia (6.9 bara), proof 200 psia (13.8 bara)
MP3	Maximum 300 psia (20.7 bara), proof 600 psia (41.4 bara)
MP4	Maximum 500 psia (34.5 bara), proof 1000 psia (69.0 bara)

Feature 10: Process Connection ANSI	
CO	No fitting (customer to supply); Available NAA only
CM	Compression fitting 2-inch Male NPT, 1500 psig (103 barg) pressure rating
CF	Compression fitting on 2-inch class 150 lb flange
CG	Compression fitting on 2-inch class 300 lb flange
CH	Compression fitting on 2-inch class 600 lb flange
PM	Packing gland* on 2-inch Male NPT, 50 psig (3.4 barg) maximum process pressure for live insertion/removal without a retractor. Packing gland itself rated to 500 psig process pressure. Packing gland live insertion/removal up to 500 psig (34.5 barg) must use a retractor.
PF	Packing gland on 2-inch class 150 lb flange
PG	Packing gland on 2-inch class 300 lb flange
PH	Packing gland on 2-inch class 600 lb flange

Feature 10: Process Connection DN	
CFD	Compression fitting on DN50/PN16 flange
CGD	Compression fitting on DN50/PN40 flange
CHD	Compression fitting on DN50/PN64 flange
PFD	Packing gland on DN50/PN16 flange
PGD	Packing gland on DN50/PN40 flange
PHD	Packing gland on DN50/PN64 flange

Note: Maximum pressure is dependent on temperature plus flange rating.

Accessories (A1): Retractor	
241-Retractor	Retractor (removable or fixed) for use with packing gland (consult factory); PM, PF, PG, PH, PFD, PGD, PHD. Use with iSeries only.

Option 1: Certification Documents	
MC	Material certificates—US Mill certs on all wetted parts
PT	Pressure test certificate
CC	Certificate of conformance
NC	NACE certification

Accessories: Manuals	
241i-IM	Additional Instruction Manual

Appendix B: Flow Meter Calculations

Inline Flow Meter Calculations

Volume Flow Rate

$$Q_V = \frac{f}{K}$$

Mass Flow Rate

$$Q_M = Q_V \rho$$

Flowing Velocity

$$V_f = \frac{Q_V}{A}$$

Where:

A = Cross sectional area of the pipe (ft²)

f = Vortex shedding frequency (pulses / sec)

K = Meter factor corrected for thermal expansion (pulses / ft³)

Q_M = Mass flow rate (lbm / sec)

Q_V = Volume flow rate (ft³ / sec)

V_f = Flowing velocity (ft / sec)

ρ = Density (lbm / ft³)

Insertion Flow Meter Calculations

Flowing Velocity

$$V_f = \frac{f}{K_c}$$

Volume Flow Rate

$$Q_V = V_f A$$

Mass Flow Rate

$$Q_M = V_f A \rho$$

Where:

A = Cross sectional area of the pipe (ft²)

f = Vortex shedding frequency (pulses / sec)

K_c = Meter factor corrected for Reynolds Number (pulses / ft)

Q_v = Volume flow rate (ft³ / sec)

Q_M = Mass flow rate (lbm / sec)

V_f = Flowing velocity (ft / sec)

ρ = Density (lbm / ft³)

Fluid Calculations

The 240i and 241i density and viscosity calculations and values are determined from Sierra proprietary fluid properties algorithm based on temperature and pressure of the fluid.

Appendix: C Glossary

A B C D

A	Cross sectional area.
ACFM	Actual Cubic Feet Per Minute (volumetric flow rate).
ASME	American Society of Mechanical Engineers
Bluff Body	A non-streamlined body placed into a flow stream to create vortices. Bluff body also called a Shedder Bar.
BTU	British Thermal Unit, an energy measurement.
Cenelec	European Electrical Code
Compressibility Factor	A factor used to correct for the non-ideal changes in a fluid's density due to changes in temperature and/or pressure.
CSA	Canadian Standards Association
d	Width of a bluff body or shedder bar
D	Diameter of a flow channel

E F G H

f	Frequency of vortices generated in a vortex flow meter, usually in Hz
Flow Channel	A pipe, duct, stack, or channel containing flowing fluid.
Flow Profile	A map of the fluid velocity vector (usually non-uniform) in a cross-sectional plane of a flow channel (usually along a diameter).
FM	Factory Mutual
Ft	Foot, 12 inches, a measure of length
Ft ²	Square feet, measure of area
Ft ³	Cubic feet, measure of volume
GPM	Gallons Per Minute
Hz	Hertz, cycles per second

I J K L

Inline Flow Meter	A flow meter which includes a short section of piping which is put inline with the user's piping.
Insertion Flow Meter	A flow meter which is inserted into a hole in the user's pipeline.
Joule	A unit of energy equal to one watt for one second. Also equal to a Newton-meter.

LCD Liquid crystal display

M N O P

\dot{m} Mass flow rate

mA Milli-amp, one thousandth of an ampere of current

μ Viscosity, a measure of a fluid's resistance to shear stress. Honey has high viscosity, alcohol has low viscosity.

nm³/hr Normal cubic meters per hour (flow rate converted to normal conditions, as shipped 101 kPa and 0° C). User definable.

ΔP Permanent pressure loss

P Line pressure (psia or bar absolute)

ρ_{act} The density of a fluid at the actual temperature and pressure operating conditions.

ρ_{std} The density of a fluid at standard conditions (usually 14.7 psia and 20° C).

Permanent Pressure Loss Unrecoverable drop in pressure.

Piezoelectric Crystal A material which generates an electrical charge when the material is put under stress.

PRTD An resistance temperature detector (RTD) with platinum as its element. Used because of high stability.

psia Pounds per square inch absolute (equals psig + atmospheric pressure). Atmospheric pressure is typically 14.696 psi at sea level.

psig Pounds per square inch gauge.

P_v Liquid vapor pressure at flowing conditions (psia or bar absolute)

Q R S T

Q Flow rate, usually volumetric.

Rangeability Highest measurable flow rate divided by the lowest measurable flow rate.

Reynolds Number (Re) A dimensionless number equal to the density of a fluid times the velocity of the fluid times the diameter of the fluid channel, divided by the fluid viscosity (i.e., $Re = \rho VD/\mu$). The Reynolds number is an important number for vortex flow meters because it is used to determine the minimum measurable flow rate. It is the ratio of the inertial forces to the viscous forces in a flowing fluid.

RTD Resistance temperature detector, a sensor whose resistance increases as the temperature rises.

scfm	Standard cubic feet per minute (flow rate converted to standard conditions, as shipped 14.696 psia and 59° F). User definable.
Shedder Bar	A non-streamlined body placed into a flow stream to create vortices. Also called a Bluff Body.
Strouhal Number (St)	A dimensionless number equal to the frequency of vortices created by a bluff body times the width of the bluff body divided by the velocity of the flowing fluid (i.e., $St = fd/V$). This is an important number for vortex flow meters because it relates the vortex frequency to the fluid velocity.
Totalizer	An electronic counter which records the total accumulated flow over a certain range of time.
Traverse	The act of moving a measuring point across the width of a flow channel.

U V W X Y Z

Uncertainty	The closeness of agreement between the result of a measurement and the true value of the measurement.
V	Velocity or voltage
VAC	Volts, alternating current
VDC	Volts, direct current
VORTEX	An eddy of fluid

Appendix D: ATEX and IECEx Certified EX Units

1. Labeling

Sierra Instruments Model 240i and 241i ATEX and IECEx Flow Transmitters that have the following label attached have been certified in compliance with:

ATEX: EN 60079-0:2012, EN 60079-1:2014, EN 60079-31:2014, EN 60529:1991+A1:2000

IECEx: IEC 60079-0:2011, IEC 60079-1:2014, IEC 60079-31:2013, IEC 60529:2001



ATEX and IECEx label, 240i/241i

The following information is provided as part of the labeling of the transmitter:

- Name and website of the manufacturer: Sierra Instruments, www.sierrainstruments.com
- The Model number, serial number and order number of the device
- Input power and maximum temperature and pressure
- Manufacturing date
- CE Mark
- ATEX/IECEx marking:

ATEX
II 2 G Ex db IIC T3 Gb
II 2 D Ex tb IIIC T200°C Db

IECEX
Ex db IIC T3 Gb
Ex tb IIIC T200°C Db

- ATEX/IECEX Ambient temperature range $T_a = -20^{\circ}\text{C}$ to $+60^{\circ}\text{C}$
- ATEX certificate number: FM15ATEX0029X; IECEX certificate number: IECEX FMG 15.0019X
- Process temperature range: -40°C to $+200^{\circ}\text{C}$
- IP 66 housing rating
- The following warnings should be obeyed:

WARNING: DO NOT OPEN WHEN AN EXPLOSIVE ATMOSPHERE IS PRESENT
WARNING: DO NOT OPEN WHEN ENERGIZED
WARNING: POTENTIAL ELECTROSTATIC CHARGING HAZARD—SEE INSTRUCTIONS

2. Type Approval Standards

The Sierra Instruments ATEX/IECEX approved flow meters have an EC Type examination certificate issued by FM Approvals and have been approved to the following standards:

ATEX: EN 60079-0:2012, EN 60079-1:2014, EN 60079-31:2014, EN 60529:1991+A1:2000
IECEX: IEC 60079-0:2011, IEC 60079-1:2014, IEC 60079-31:2013, IEC 60529:2001

3. Zone, Gas Group, Category and Temperature class

The Sierra Instruments 240i241i ATEX and IECEX units have been certified ATEX/IECEX marking:

ATEX
II 2 G Ex db IIC T3 Gb
II 2 D Ex tb IIIC T200°C Db

IECEX
Ex db IIC T3 Gb
Ex tb IIIC T200°C Db

This means that the units can be installed in locations with the following conditions.

3.1. Area Classification

Zone 1	Area in which an explosive gas atmosphere is likely to occur in normal operation occasionally
Zone 2	Area in which an explosive gas atmosphere is not likely to occur in normal operation and if it does occur, is likely to do so only infrequently and will exist for a short period only
Zone 21	Place in which an explosive atmosphere in the form of a cloud of combustible dust in air is likely to occur in normal operation occasionally
Zone 22	Place in which an explosive atmosphere in the form of a cloud of combustible dust in air is not likely to occur in normal operation but, if it does, will persist for a short period only

3.2. Gas Grouping

Group IIA	Propane
Group IIB	Ethylene
Group IIC	Hydrogen and Acetylene

3.3. Equipment Category

2GD (Zone 2 suitable for Gasses and Dust explosive environments)

3.4. Temperature Classification for ATEX

T6	40	70
T5	50	80
T4	85	115
T3	150	180
T2	250	280

3.5. Ambient Temperature Range

Ambient temperature range -20°C to +60°C

4. Safe Use of ATEX Approved Equipment

4.1. Notes on Safe Use of the ATEX Approved Equipment

Approved usage of the meter is restricted to fluids compatible with the wetted materials of the flow meter and within the restrictions on temperature and pressure as defined in the product manual.

4.2. Mounting, Commissioning, and Operation

The device has been designed to operate safely in accordance with the current technical and safety regulations of the EU. If installed incorrectly or used for applications for which it is not intended, it is possible that application related changes may arise. For this reason, the instrument must be installed, connected, operated, and maintained according to the instructions in this and the specific product operating manual.

Persons handling/installing or commissioning this equipment must be authorized and suitably qualified. The manual must be read, understood, and the instructions must be followed. Modifications and repairs to the device are only permissible when they are expressly approved in this manual.

4.3. Explosive Hazardous Area

If the device is to be installed in an explosive hazardous area, then the specifications in the certificate as well as all national and local regulations must be observed.

The instrument will be delivered with the certified ATEX/IECEX marking :

ATEX

II 2 G Ex db IIC T3 Gb

II 2 D Ex tb IIIC T200°C Db

IECEX

Ex db IIC T3 Gb

Ex tb IIIC T200°C Db

The certificate type can be identified from the second group of numbers (Feature 2: Approvals) on the model code stamped on the nameplate. For example:

1= NAA : Not suitable for hazardous areas, Non-Agency Approved.

2= cFMus : Explosion proof for Class I, Division 1, Groups B, C, D

3= ATEX/IECEX:

ATEX

II 2 G Ex db IIC T3 Gb

II 2 D Ex tb IIIC T200°C Db

IECEX

Ex db IIC T3 Gb

Ex tb IIIC T200°C Db

This manual addition only applies to ATEX/IECEX units.

The unit is supplied without cable glands for the power and signal. It is the user's responsibility to select suitable cable glands that meet or exceed the required ATEX/IECEX approval and that are suitable for the signal and power cable used. The connections on the electronics housing for the input power and signal cable glands is 3/4"-14 female NPT threads according to the NPT requirements of ANSI B1.20.1 plus +0.5 to +2.0 turns deeper.

WARNING: UNUSED WIRING ENTRIES ARE TO BE CLOSED USING SUITABLY CERTIFIED PLUGS TO MAINTAIN THE ENCLOSURE TYPE OF PROTECTION

NOTE: Please insure that when you mount these cable glands they are made-up wrench tight. At least 3-1/2 turns of the thread must be engaged inside of the electronics enclosure.

4.4. Special Conditions for a Safe Use/Specific Conditions of Use

The ambient temperature must never overrun the following limits: -20...+60°C. The surface temperature of the device (indicated on the device) must never exceed this temperature and must take into account both ambient and fluid temperatures.

Consult the manufacturer if dimensional information on the flameproof joints is necessary.

The flameproof joints of the equipment are not intended to be repaired. Consult the manufacturer if repair of the flameproof joints is necessary.

For probes longer than 13 inches, a suitably certified conduit sealing device is required to be installed between the main enclosure and the probe body. The seal shall be located within 13 inches of the main enclosure.

4.5. Particular Recommendations: Closing the Cover

The safety is guaranteed as long as the covers are correctly screwed and locked.

The lid locking screws are #10-24 Socket Head Cap Screws (SHC Screw) that use a 5/32-inch hex head wrench/driver to adjust. To lock the lids firmly tighten down/secure the lid and then back out the associated SHC screw firmly so that the lid is secured and locked in place. If one of the ribs/bumps on the lid happens to line up so it is blocking access to the SHC screw then either slightly tighten the lid more or loosen the lid slightly, just enough to gain access to the lid locking SHC screw. *Note that this very minor adjustment, if necessary, does not affect the leak integrity of the enclosure.* To un-lock the lid allowing for removal, just turn in the associated SHC screw so that it is no longer in contact with the lid, then the lid can be removed. There are two lids to be locked on the main enclosure and two lids to be locked on the remote enclosure (If E4 feature was ordered) in order to maintain the safety ratings.

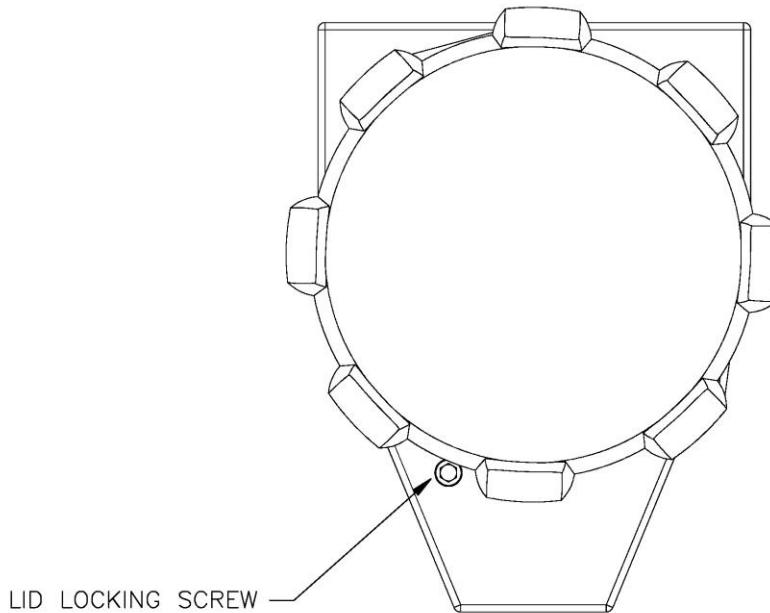

InnovaMass 240i/241i Main and Remote Enclosures Shown With Lid Locking Screw (2 places, front and rear)

The following warnings should be obeyed:

WARNING: DO NOT OPEN WHEN AN EXPLOSIVE ATMOSPHERE IS PRESENT

WARNING: DO NOT OPEN WHEN ENERGIZED

WARNING: POTENTIAL ELECTROSTATIC CHARGING HAZARD—SEE INSTRUCTIONS

To minimize an electrostatic charging hazard on the exterior of the enclosures both the main and remote (If ordered) enclosures should be connected to earth ground, see section 7 below for more details.

5. Remote Electronics

Sierra Thermal flow transmitters with E4 in the model code have remote electronics. They have a cable with glands between the sensor and the electronics. These units are marked with the same label and markings as the non-remote E2 configuration, one label on each of the two enclosures, see section 1 for information.

Please see the previous sections for explanations of all labeling requirements.

If the remote wires need to be disconnected refer to the remote sensor wiring section of the instruction manual.

6. Maintenance

6.1. External Maintenance

The Sierra flow meters can be externally maintained with a dry clean cloth.

6.2. Sensor Maintenance

The sensor can be maintained by switching off the power, removing the probe from the process and cleaning the probe with a solvent compatible with 316SS. After cleaning the probe clean and dry the sensor with compressed air before you insert it back it the process. It is not recommended to use any Ultrasonic Bath cleaning.

6.3. Internal Maintenance

Please make sure that the internals of the unit always stay dry and clean. There are no user maintainable components inside the electronic compartment.

7. Earthing

The Sierra Instruments units must be connected to a good quality earth. The units are provided with internal and external earthing terminals.

7.1. External Earthing

The external earthing connections are located on the boss on the outside of both the main housing and remote housing (E4 option if ordered) and consist of an 18-8SS pan head Phillips screw (10-24 UNC-2B thread) and a serrated tooth #10 ring terminal for 16-14 AWG wire.

7.2. Internal Earthing

The internal earthing connection is located in the main electronics housing terminal side and consist of an 18-8SS pan head Phillips screw (10-24 UNC-2B thread) and a serrated tooth #10 ring terminal for 16-14 AWG wire.

8. Warning



The electronics for ATEX and IECEx units contain special dedicated electronics. No customer modifications are available and are strictly forbidden. Any modification or adjustment to the electronics can be performed at the factory only.

9. Returning Equipment to Factory

Factory Calibration—All Models

Sierra Instruments maintains a fully-equipped calibration laboratory. All measuring and test equipment used in the calibration of Sierra transducers are traceable to NIST Standards. Sierra is ISO-9001 registered and conforms to the requirements of ANSI/NCCL-Z540 and ISO/IEC Guide 25.

Instructions for Returning Your Instrument for Service

The following information will help you return your instrument to Sierra Instruments' Factory Service Center and will ensure that your order is processed promptly. Prices may vary depending on the flow range, type of gas and operating pressure of your unit. To request detailed pricing, contact your local Sierra Instruments distributor or contact one of our offices directly.

Please follow these easy steps to return your instrument for factory service:

1. To obtain a Return Materials Authorization (RMA) go to:
www.sierrainstruments.com/rma/new.php to create a Sierra Account.
2. Once you have created an account, click on the Submit New RMA tab and fill in the RMA form and follow the instructions. You will receive an email confirmation once you have submitted your RMA.
3. Print a copy of the RMA (that now includes RMA #) and send a copy of the RMA form along with your meter back to the factory.

If you require service beyond calibration, but do not know which service(s) will be required, describe the symptoms as accurately as possible on the RMA form.

Pack your instrument carefully. Use the original packaging and foam or bubble wrap (packing peanuts NOT recommended) and include a copy of the RMA form (complete with Sierra supplied RMA number) with the unit(s).

Ship the unit(s) to the following address:

**Sierra Instruments, Inc.
Attention: Factory Service Center
5 Harris Court, Building L
Monterey, CA 93940 USA
RE: RMA# (your number)**

**For Global Service Centers, go to
<http://www.sierrainstruments.com/facilities.html>**

Addendum A: Installation Instructions Cable Gland

Manufacturer:

Sealcon (Hummel)
7374 S. Eagle Street
Centennial, CO 80112-4221
USA

Cable Glands used on Sierra E4 units:

Sealcon: CD13NR-BE-N-ASMBLD PK=10 (Sierra Reference 30-0647)

Brief Description:

The Sealcon (Hummel) type cable gland is for use in the appropriate Hazardous Areas with braided shield cable. It gives environmental protection to IP66. This cable gland is an EMI/RFI proof Nickel Plated Brass type. A termination suitable for EMI/RFI protection is made using braided shield cables with these glands. These glands are non-corrosive and are resistant to salt water, weak acids, weak alkalis, alcohol, esters, ketones, ether, gasoline, mineral, animal & vegetable oil. RoHS and Deca BDE compliant.

Warning:

	PLEASE STUDY CAREFULLY ALL PAGES OF THESE INSTRUCTIONS BEFORE INSTALLATION.
---	--

These glands should not be used in any application other than those mentioned here or in our Data Sheets, unless Sealcon (Hummel) states in writing that the product is suitable for such application. Sealcon (Hummel) can take no responsibility for any damage, injury or other consequential loss caused where the glands are not installed or used according to these instructions. This leaflet is not intended to advice on the selection of cable glands.

PART NUMBERS	CABLE WIRE	THREAD TYPE AND SIZE For Detail items see page 29	DIMENSIONS INCHES (MM)							
			A Clearance 1/32" 1.57	B Body Height Dome Fittings		C Body Height Flex Fittings	D Thread Length Fittings	E/E Measuring Flex Fittings		
				-BE	-FE					
Dome Fittings	Flex Fittings	Dome Fittings								
CD07A-BE CD07AR-BE	CF07AA-BE CF07AR-BE	CD07AA-FE	.11-.26 (3.45) .08-.20 (2.15)	1/8" 1/4" NPT	.49 (12)	.75 (19)	.84 (21)	2.16 (55)	20 (5)	.55 (14)
CD09A-BE CD09AR-BE	CF09AA-BE CF09AR-BE	CD09AA-FE	.18-.31 (4.6) .08-.24 (2.1)	PG 9	.60 (15)	.82 (21)	1.10 (28)	2.60 (66)	24 (6)	.67 (17)
CD09NA-BE CD09NAR-BE	CF09NA-BE CF09NAR-BE	CD09NA-FE	.16-.31 (4.1) .08-.24 (2.1)	3/8" NPT	.68 (17)	.82 (21)	1.14 (29)	2.60 (66)	.58 (15)	.65 (17) .65 (17)
CD11A-BE CD11AR-BE	CF11AA-BE CF11AR-BE	CD11AA-FE	.20-.36 (5.1) .11-.27 (3.7)	PG 11	.73 (18)	.87 (22)	1.14 (29)	3.03 (77)	24 (6)	.79 (20)
CD13AA-BE CD13AR-BE	CF13AA-BE CF13AR-BE	CD13AA-FE	.24-.47 (6.1) .20-.39 (5.1)	PG 13.5	.80 (20)	.84 (21)	1.22 (31)	3.46 (88)	26 (6.5)	.87 (22)
CD13NA-BE CD13NAR-BE	CF13NA-BE CF13NAR-BE	CD13NA-FE	.24-.47 (6.1) .20-.39 (5.1)	1/2" NPT	.83 (21)	.84 (21)	1.28 (32)	3.46 (88)	.51 (13)	.85 (22) .85 (22)
CD16AA-BE CD16AR-BE	CF16AA-BE CF16AR-BE	CD16AA-FE	.29-.50 (7.4) .21-.51 (7.1)	PG 16	.88 (22)	.81 (21)	1.28 (32)	3.66 (93)	28 (6.5)	.94 (24)
CD21AA-BE CD21AR-BE	CF21AA-BE CF21AR-BE	CD21AA-FE	.51-.71 (13.1) .39-.63 (9.9)	PG 21	1.12 (28)	.84 (21)	1.90 (48)	4.37 (111)	27 (7)	1.18 (30)
CD21NA-BE CD21NAR-BE	CF21NA-BE CF21NAR-BE	CD21NA-FE	.51-.71 (13.1) .39-.63 (9.9)	3/4" NPT	1.05 (27)	.88 (22)	1.93 (49)	4.37 (111)	.51 (13)	1.18 (30)
CD29A-BE CD29AR-BE		CD29AA-FE	.71-.88 (18.2) .51-.79 (13.0)	PG 29	1.47 (37)	1.14 (29)	1.89 (48)	-	31 (8)	1.57 (40)
CD36AA-BE CD36AR-BE		CD36AA-FE	.81-1.28 (20.5) .71-1.22 (22.2)	PG 36	1.85 (47)	1.38 (35)	1.89 (48)	-	31 (8)	1.87 (50)
CD42A-BE CD42AR-BE		CD42AA-FE	1.28-1.90 (32.3) .88-1.22 (22.3)	PG 42	2.13 (54)	1.46 (37)	1.77 (45)	-	35 (9)	2.24 (57)
CD48A-BE CD48AR-BE		CD48AA-FE	1.46-1.73 (37.1) 1.14-1.38 (29.3)	PG 48	2.34 (59)	1.50 (38)	1.81 (46)	-	38 (10)	2.52 (64)

SPECIFICATIONS:
Pressure rating:
 150 PSIG (10 BAR) NEMA 4x and 6
 (Submersible) IP68
Materials:
 Body & Nut: Nickel Plated Brass
 Splined Bushing: Nickel Plated Nylon (-FE)
 Nylon (-BE)
 Form Seal & O-Ring: Buna-N
Operating Temperature:
 -40°F to 212°F (-40°C to 100°C)

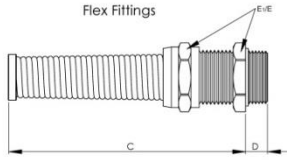
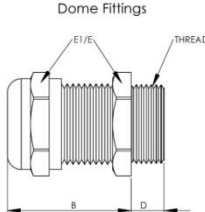

- NOTES:
 1) GENERAL DIMENSIONS DRAWINGS.
 2) DIMENSIONS [] ARE IN INCHES.
 3) DIMENSIONS NOTED ARE FOR REFERENCE ONLY.

Third angle projection

SEALCON

14853 HINDSDALE AVE. SUITE D
 CENTENNIAL, CO 80112-4240, USA
 TEL: +1-303-699-1135
 TOLL FREE: +1-800-456-9012
 E-MAIL: info@sealconusa.com
 WEBSITE: www.sealconusa.com



[▶ 1/4" NPT](#)
[▶ 3/8" NPT](#)
[▶ 1/2" NPT](#)
[▶ 3/4" NPT](#)

Easy Quote
Expand

Request Catalogs / Samples
 (303) 699-1135
 1-800-456-9012

- Strain Relief Fittings**
- ▶ Nylon Fittings
 - ▼ Nickel Plated Brass Fittings
 - ▶ Standard Thread
 - ▶ Elongated Thread
 - ▶ Snap Elbow
 - ▶ Multi-Hole
 - ▶ Mini Wadi - Smallest Cable O.D.
 - ▶ Wadi XL - Largest Cable O.D.
 - ▶ High Performance - Clamp
 - ▶ High Performance - Clamp, Elongated Thread
 - ▼ EMI/RFI (Standard)
 - ▶ PG Threads
 - ▼ NPT Threads
 - ▶ 1/4" NPT
 - ▶ 3/8" NPT
 - ▶ 1/2" NPT
 - ▶ 3/4" NPT
 - ▶ Metric Threads
 - ▶ EMI/RFI (Standard), Elongated
 - ▶ EMI/RFI (Standard), w/ Clamp
 - ▶ EMI/RFI (Feed-Through)
 - ▶ EMI/RFI (Feed-Through), Elongated Thread
 - ▶ PVDF
 - ▶ Stainless Steel
 - ▶ Accessories
 - Sealcon Closeout Stock Sale
 - Resources**
 - Catalogs
 - Flyers
 - Industry Flyers
 - Press Releases
 - Product Videos

[Sealcon Home](#) | [Strain Relief Index](#) | [Nickel Plated Brass Fittings - EMI/RFI Proof \(Standard\) - NPT Threads](#)

**Strain Relief Fittings, Cord Grips, Cable Glands
EMI/RFI Proof Dome and Flex Fittings - 1/2" NPT Thread**

[Strain Relief](#) | [Corresponding Accessories](#) | [Features](#) | [Technical Data](#) | [Other Accessories](#)

- Features:**
- Liquid Tight - Submersible to 300 ft. - NEMA 4x & 6 (IP68 / IP 69 K)
 - Highest Pressure Rating - Patented form seal guarantees 150 psig (10 bar)
 - Flame protected - V0 Rated according to UL 94
 - Halogen - and Phosphorous free materials
 - Large Selection - Cable Range from .08" (2mm) to 1.38" (35mm)
 - Non-Corrosive - Resistant to salt water, weak acids, weak alkalis, alcohol, esters, ketones, ether, gasoline, mineral, animal & vegetable oil.
 - Durable - Rugged Construction
 - Environmentally compliant - RoHS & Deca BDE

This EMI/RFI Proof Nickel Plated Brass Strain Relief with 1/2" NPT Thread will provide your application with a product made of exceptional quality.

Modularity: The Strain Relief allows you to increase and decrease the cable opening by just swapping out the standard and reduced inserts.

The self locking ACME thread on the dome and flex top ensures that the overlapping splines apply a concentric seal, thereby preventing the form seal from being pulled out of the fitting & ensuring pull-out protection of your cable without damaging it.

Kinking and chafing of the cable is eliminated with use of the Flex Nut.

Assembly Instructions

Step 1

- Strip cable
- Expose braided shield

Step 2

- Feed cable through dome nut and clamping insert
- Fold braided shield over clamping insert and O-ring
- Make sure that braided shield overlaps the O-ring by 3/32" (2 mm)

Step 3

- Push clamping insert into body and tighten dome nut
- Assemble into housing
- Finished

WE PROVIDE CUSTOMERS WITH CABLE MANAGEMENT SOLUTIONS!

- Quantity Discounts!
- No Minimum Orders!
- Same Day Shipping!
- Blanket Orders!
- Quick and Friendly Service!
- All Major Credit Cards!

Search

2D/3D CAD DOWNLOAD

Click the button below to view download options.
Click again to close the section.

[CD12NR-BE](#)
[CD12NR-BE](#)
[CF12NR-BE](#)
[CF12NR-BE](#)

[Data Sheet](#)

Dimensions and Specifications may change without prior notice

Questions?

[Click To Chat!](#)

- Advertisements**
- Product News**
- Product Applications**
- Technical Info**
- Strain Relief Fittings, Conduit & Accessories**
- Circular Connectors**
- Enclosures**
- Products By Industry**
- Certificates / Approvals**
- FAQ**
- Benefits & Features**
- Why Choose Sealcon**
- Ex Hazardous Glands**
- EXIOS Armored**
- EXIOS Armored + Barrier**
- Nylon Cable Glands**
- Nickel Plated Brass**
- INOX Stainless Steel**
- Circular Connectors**
- Accessories**

THE EXCLUSIVE IMPORTER OF



HI-TECH CONTROLS, INC. provides cable products at competitive prices with exemplary customer service. Inventory in Excess of \$25 Million allows the immediate shipment of almost all standard cable types and sizes.

Cables, Wires & Accessories: Domestic & Imported
 Importer of **HELLUKABEL®**. Approvals: RoHS, UL, CSA, Harmonized & CE. We offer cables for Power, Control, High/Low Temp., Hi-Flex, Robotic, Track, Servo, VFD, Composite, Ribbon, Data(CAT), Single Conductor, etc!

Plastic Enclosures: Indoor / Outdoor NEMA 4x
 Exclusive importer of **HENSEL ENCLOSURES**. Industrial Strength, UV & Impact Resistant, Modular Expandable.
Materials: Polycarbonate, Polystyrene, Powder-coated Steel
Types: Gray or Transparent Lids, available with Hinges & Latches, Opaque/ Transparent covers, Plain Walls or Knockouts, Hazardous Location, Fire Proof / Functional Integrity, Offshore Applications (Saltwater-proof)
Accessories: DIN rails, Mounting plates, Terminal blocks, Hole plugs, etc.

Aluminum Enclosures: Custom
 Custom Customize your own Control Solution Device with the following Cord Grips, Momentary Push Buttons, etc.
 NEMA Enclosure Rating: 4, 4x (IP66). We offer 1, 2 and 3 Button Solutions. Industrial Enclosures are made of Powder Coated Gray Die Cast Aluminum alloy. We do the assembly at one low price.

Pneumatic Components: Fittings, Tubing, Valves & Gauges
Fittings: Nickel Plated Brass, Composite, Brass & Compression Fittings, the patented & longstanding Pro-Fit® system, High Pressure Dual Seal fittings, etc.
Valves: Flow Control, Manual, Air Piloted, Solenoid, Brass
 We also offer **Tubing, FRL Units (Filters, Regulators & Lubricators), Gauges, Timers and Relays**. Manufacturers include **CAMOZZI, COUPLINGS COMPANY, PNEUMADYNE, INFITEC**, etc.

7374 S. Eagle Street
 Centennial, CO 80112-4221 USA
 Toll Free: 800-456-9012 / 303-699-1135 Fax: 303-680-5344



[Top of Page](#)

Copyright © 2012 Sealcon LLC. All Rights Reserved

[|Strain Relief Fittings|Strain Relief for Hazardous Areas|Circular Connectors|Enclosures|Conduit System|Adapter,Enlarger,Reducer|Accessories|Product Index|Media|Online Catalog|Company Overview|Contact|Privacy Policy|Email Us|Copyright Notice|Site Map|Search|Quote Request](#)

Addendum B: Agency Approvals

View all InnovaMass 240i/241i agency approval certificates on our website along with all documentation relating to the InnovaMass 240i/241i.

InnovaMass 240i sierrainstruments.com/products/downloads/innovamass-240i

InnovaMass 241 sierrainstruments.com/products/downloads/innovamass-241i

Appendix E: Warranty Policy

Warranty Statement

All Sierra products are warranted to be free from defects in material and workmanship and will be repaired or replaced at no charge to Buyer, provided return or rejection of product is made within a reasonable period but no longer than one (1) year for calibration and non-calibration defects, from date of delivery. To assure warranty service, customers must register their products online on Sierra's website. Online registration of all of your Sierra products is required for our warranty process.

Read complete warranty policy at www.sierrainstruments.com/warranty

Register Warranty Online

Register now at www.sierrainstruments.com/register

Learn more about Sierra's warranty policy at www.sierrainstruments.com/warranty