

Smart-Trak[®] 2 Series 100 Mass Flow Meters and Controllers

INSTRUCTION MANUAL



IM-100, Revision: B
August 2010



SIERRA[®]
EXPERIENCE OUR PASSION FOR FLOW!

GLOBAL SUPPORT LOCATIONS: WE ARE HERE TO HELP!

CORPORATE HEADQUARTERS

5 Harris Court, Building L Monterey, CA 93940
Phone (831) 373-0200 (800) 866-0200 Fax (831) 373-4402
www.sierrainstruments.com

EUROPE HEADQUARTERS

Bijlmansweid 2 1934RE Egmond aan den Hoef
The Netherlands
Phone +31 72 5071400 Fax +31 72 5071401

ASIA HEADQUARTERS

Rm. 618, Tomson Centre, Bldg A, 188 Zhang Yang Road
Pu Dong New District, Shanghai, P.R. China
Phone: + 8621 5879 8521 Fax: +8621 5879 8586

IMPORTANT CUSTOMER NOTICE: OXYGEN SERVICE

Sierra Instruments, Inc. is not liable for any damage or personal injury, whatsoever, resulting from the use of Sierra Instruments standard mass flow meters or controllers for oxygen gas. You are responsible for determining if this mass flow meter or controller is appropriate for your oxygen application. You are responsible for cleaning the mass flow meter or controller to the degree required for your oxygen flow application.

© COPYRIGHT SIERRA INSTRUMENTS 2010

No part of this publication may be copied or distributed, transmitted, transcribed, stored in a retrieval system, or translated into any human or computer language, in any form or by any means, electronic, mechanical, manual, or otherwise, or disclosed to third parties without the express written permission of Sierra Instruments. The information contained in this manual is subject to change without notice.

TRADEMARKS

Smart-Trak[®] 100 Series and Dial-A-Gas[™] is a Registered Trademark of Sierra Instruments, Inc. Other product and company names listed in this manual are trademarks or trade names of their respective manufacturers.

Table of Contents

Chapter 1: Introduction	5
Welcome to the future of gas flow measurement!	5
Using This Manual.....	5
Safety Information	6
Receipt of your instrument.....	7
The Smart-Trak 2 Flow Sensing Principle.....	9
Chapter 2: Installation	9
Before You Begin Installation	11
Pre-Installation Check List	12
Installing the Instrument—Plumbing.....	12
Compression Fittings	13
VCO Fittings	13
VCR Fittings	14
1/4 Inch Female NPT	14
Installing your Instrument—Mechanical Mounting	15
Installing your Instrument—Electrical Connections	16
Figure 2-3: HD DB-15 Connector Pin Configuration (on the instrument).....	18
Figure 2-4: Wiring Definitions for Optional Communication Cable.....	18
Figure 2-5: Power Supply Requirements.....	19
Chapter 3: Analog Operation	22
Analog Operation, Mass Flow Controller.....	23
Smart-Trak 2 Features.....	24
Setpoint Adjustment.....	24
Changing the Output or Setpoint Signals.....	24
Over-Range Condition.....	24
Manual Valve Override—Valve Close.....	25
Manual Valve Override—Valve Purge Function	25
Important Notes About Purging.....	25
Purging Non-Reactive Gases:.....	25
Purging Reactive Gases:	25
Chapter 4: Digital Operation with Pilot Module	27
Introduction to Pilot Module Features and Capabilities	27
Pilot Module Operation, Mass Flow Controllers	29
Pilot Module Operation, Mass Flow Controllers:.....	30
Making Changes Using the Lower Level Screens:.....	38
Lost Passwords and General Customer Service:	47
Chapter 5: Digital Operation RS-232 & Smart-Trak 2 Software	48
Power Up Your Instrument	48
Power Up Your Computer	51
Loading the Smart-Trak 2 Software	51
Connecting Smart-Trak 2 to Your Computer	52

If your computer has a serial port.....	51
If your computer has no serial port, but has a USB port.....	53
If you plan to control more than one Smart-Trak 2 instrument from your computer.....	53
Running The Smart-Trak 2 Software.....	55
Chapter 6: Technical Support & Service	68
Factory Calibration—All Models.....	70
Instructions for Returning Your Instrument for Service.....	70

Appendix A: Gas Tables & K-Factors

Appendix B: Product Specifications

Appendix C: Flow Chart for Pilot Module User Interface

Appendix D: PIN Configuration

Appendix E: Product Dimensions and Mounting

Appendix F: Micro-Trak

Appendix G: Smart-Trak Basic Commands

CHAPTER 1: INTRODUCTION

Welcome to the future of gas flow measurement!

This manual is your guide to Smart-Trak 2. Visit the Sierra Instruments website www.sierrainstruments.com any time for more information about this product.

The Smart-Trak 2 instruments offer a variety of features for ease of operation. Among these features:

- ✓ **Dial-A-Gas:** allows a user to change from among 10 gases while maintaining accuracy.
- ✓ **The Optional Pilot Module:** control electronics that offers both display and control options at the user's fingertips.
- ✓ **Digital Electronics:** maximum performance with minimum noise plus exceptional tuning capability.
- ✓ Choice of **Analog Communications Options and RS-232** with every Smart-Trak 2 instrument.
- ✓ **Flexible Design** with many functions that can be re-configured on-site by the user.
- ✓ **Compact Footprint** that allows Smart-Trak 2 to fit almost anywhere.
- ✓ **Wide range of sizes** for gas flow from 0.1 sccm to 1400 slpm.
- ✓ **And many more**

Using This Manual

This manual is organized into six chapters:

- **Chapter 1:** Introduction and Theory of Operation.
- **Chapter 2:** Installation, Plumbing & Wiring instructions.
- **Chapter 3:** Analog Operation.
- **Chapter 4:** Digital Operation with the Optional Pilot Module.
- **Chapter 5:** Digital Operation with RS-232 & Smart-Trak 2 Software.
- **Chapter 6:** Technical Support and Service.

There are also 6 Appendices:

- **Appendix A:** Smart-Trak 2 Pre-Programmed gases, Conversion Formula and Gas Tables.
- **Appendix B:** Product Specifications, useful Optional Parts & Accessories
- **Appendix C:** Flowchart for the Pilot Module.
- **Appendix D:** PIN Configuration of the mini-D connector
- **Appendix E:** Dimensional Drawings & Mounting Instructions
- **Appendix F:** Special Instructions for Installation and Operation of the Micro-Trak ultra-low flow instruments.

Throughout this manual, we use the word *instrument* as a generic term to represent all models of Sierra Instruments' **Smart-Trak 2 Series 100** mass flow meters and controllers.

SAFETY INFORMATION

Caution and warning statements are used throughout this book to draw your attention to important information.



Warning!

This statement appears with information that is important to protect people and equipment from damage. Pay very close attention to all warnings that apply to your application.



Caution!

This statement appears with information that is important for protecting your equipment and performance. Read and follow all cautions that apply to your application.

RECEIPT OF YOUR INSTRUMENT

When receiving the instrument, carefully check the outside packing carton for damage that may have incurred during shipment. If the carton is damaged, notify the local carrier and submit a report to the factory or distributor. Remove the packing slip and check that all ordered components are present and match your specifications (as ordered). Make sure any spare parts or accessories are not discarded with the packing material. Do not return any equipment to the factory without first contacting one of Sierra's Technical Support Centers:

USA (Headquarters) Customer Service:

TOLL FREE: 800-866-0200
PHONE: 831-373-0200
FAX: 831-373-4402
EMAIL: service@sierrainstruments.com

European Customer Service:

PHONE: +31 72 5071400
FAX: +31 72 5071401
EMAIL: service@sierra-instruments.nl

Asia Customer Service:

PHONE: + 8621 5879 8521
FAX: +8621 5879 8586
EMAIL: www.sierra-asia.com

DEFINITIONS USED IN THIS MANUAL

The following terms are used frequently in this manual. They are presented here with their definitions for your information.

Setpoint—The command or control signal supplied to a flow controller is called its setpoint. The controller will maintain the flow at this value.

Full scale—The highest flow that an instrument will meter within its specified accuracy. It is often possible for an instrument to measure a flow beyond its full scale value, but the accuracy of this measurement may be outside of published specifications.

Purge—The Smart-Trak 2 Mass Flow Controller is supplied with the ability to open the valve far beyond the full scale position to allow them to be cleaned. This is usually accomplished by blowing clean, dry nitrogen through the instrument. When the valve is opened to this cleaning position, it is said to be in the Purge mode.

LFE—Laminar Flow Element (LFE) or bypass generates pressure drop forcing a small fraction of the total flow to pass through the sensor capillary tube.

THE SMART-TRAK 2 FLOW SENSING PRINCIPLE

The operating principle of the Smart-Trak 2 instruments is based on heat transfer and the first law of thermodynamics. During operation process gas enters the instrument's flow body and divides into two flow paths, one through the sensor tube, and the other through the laminar flow bypass. The laminar flow bypass (often called LFE which stands for "laminar flow element") generates a pressure drop, $P_1 - P_2$, forcing a small fraction of the total flow to pass through the sensor tube (\dot{m}_1).

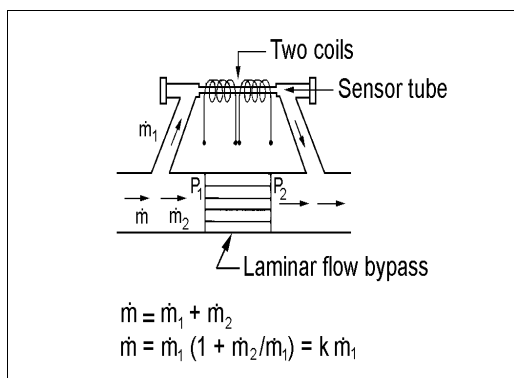

Figure 1-1. Flow Paths through the Instrument

Two resistance temperature detector (RTD) coils around the sensor tube direct a constant amount of heat (H) into the gas stream. During operation, the gas mass flow carries heat from the upstream coil to the downstream coil. The resulting temperature difference (ΔT) is measured by the Smart-Trak 2 microprocessor. From this, Smart-Trak 2 calculates the output signal. Since the molecules of the gas carry away the heat, the output signal is linearly proportional to gas mass flow.

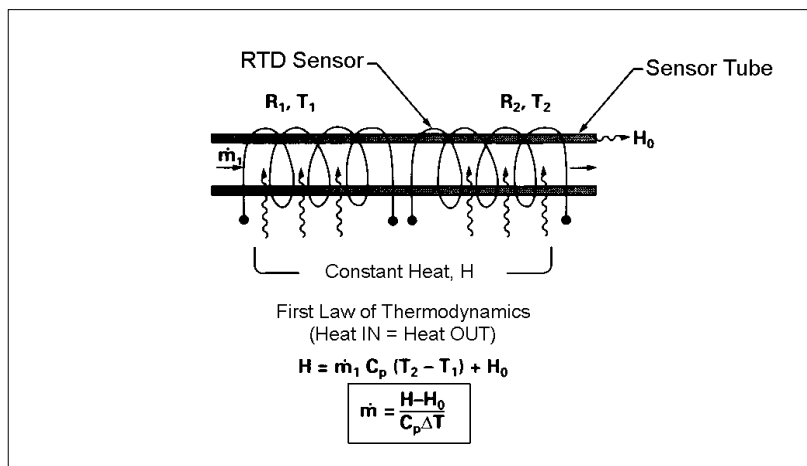

Figure 1-2. Flow Measuring Principle

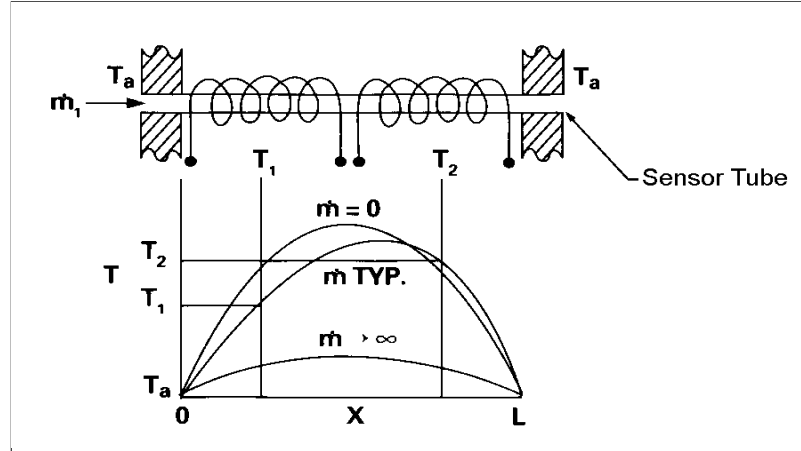

Figure 1-3. Sensor Temperature Distribution

Figures 1-2 and 1-3 show the mass flow through the sensor tube as inversely proportional to the temperature difference of the coils. The coils are legs of a bridge circuit with an output voltage in direct proportion to the difference in the coils' resistance; the result is the temperature difference (ΔT). Two other parameters, heat input (H) and coefficient of specific heat (C_p) are both constant. Through careful design and attention to these parameters, this output signal is made linear over the transducer's normal operating range (Figure 1-4). As a result, the measured flow through the sensor tube is directly proportional to the gas flow in the main body.

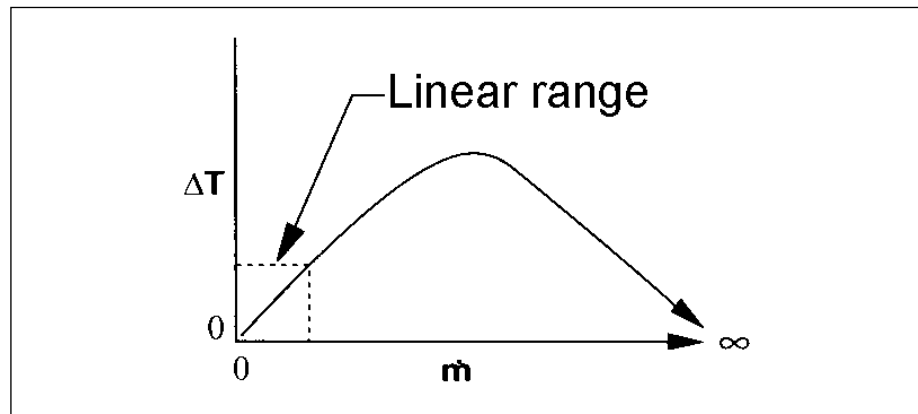

Figure 1-4. Linear Range of the Transducer's Output Signal

In the Smart-Trak 2 mass flow *controllers*, the gas which flows through the monitoring section is precisely regulated by the built-in electromagnetic valve. The normally closed valve is similar to an on/off solenoid valve, except that the current to the valve coil, and hence the magnetic field, is modulated so that the ferromagnetic valve armature, or valve plug, assumes the exact height above the valve's orifice required to maintain the valve's command flow (set point). The result is excellent resolution.

CHAPTER 2 INSTALLATION

Before You Begin Installation



Warning!
Injury can result if line pressure exceeds the maximum rating of 500 psig (34 barg).

Before installing the instrument, ensure that the installation site conforms to the specific operating parameters recorded on the instrument’s Data Label. The Data Label is mounted on the back of the instrument electronics enclosure (see sample Data Labels in Figure: 2-1). This is critical because each instrument is configured for a specific application range. Please review the gas or gases, the mounting orientation, the maximum flow range(s), the inlet and outlet pressure(s), and the operating temperature(s). The line pressure should not exceed 500 psig (34 barg). The temperature should not exceed 122°F (50°C). The minimum operating temperature is 32°F (0°C) and ambient temperature is 0-50°C. If your application exceeds any of these parameters, contact your Sierra Sales Agent before installation. You may also contact one of Sierra’s Technical Support Centers. FACTORY USA: TOLL FREE: 800-866-0200 or PHONE: 831-373-0200 or FAX: 831-373-4402 or EMAIL: service@sierrainstruments.com

Figure 2-1: Examples of Smart-Trak 2 Data Labels

SIERRA INSTRUMENTS, INC. <small>THE MASS FLOW COMPANY</small>		5 Harris Court Bldg. L Monterey, Ca. 93940 800-866-0200 831-373-0200	
Mass Flow Controller			
Model			
C100L-L-DD-LE-5-OV1-SV1-PV1C-V1-S1			
Serial	Order	Mfg. Date	
10067	10001	7/1/03	
Gas			
Air			
Range & Units		STP	
0-1 SLPM		70F / 1 ATM	
Output Signal		Set Signal	
0-5 Vdc		0-5 Vdc	
Orientation		Supply	
Horizontal		12-15 Vdc	
Inlet Press.	Outlet Press.	Max. Press.	
30 PSI	ATM	500 PSIG	
Oper. Temp	Max. Temp	Connections	
70F	122F	1/4" VCO	
O-ring Material		Valve Seat Material	
Viton		Viton	
Technician	Cal. Date	Recal. Date	

Made in USA		ISO 9001 Registered	

SIERRA INSTRUMENTS, INC. <small>THE MASS FLOW COMPANY</small>		5 Harris Court Bldg. L Monterey, Ca. 93940 800-866-0200 831-373-0200	
Mass Flow Meter			
Model			
M100L-L-DD-LE-5-OV1-SV1-PV2-V4-S4			
Serial	Order	Mfg. Date	
10068	10001	7/1/03	
Gas			
Nitrogen			
Range & Units		STP	
0-1 NM3/hr		21C/760 mmHg	
Output Signal		Set Signal	
4-20 mA		4-20 mA	
Orientation		Supply	
Vertical Flow Down		24-30 Vdc	
Inlet Press.	Outlet Press.	Max. Press.	
2 BARG	ATM	35 BARG	
Oper. Temp	Max. Temp	Connections	
20C	50C	3/8 VCR	
O-ring Material		Valve Seat Material	
Viton		Viton	
Technician	Cal. Date	Recal. Date	

Made in USA		ISO 9001 Registered	

Pre-Installation Check List

1. **Double-check to be sure that the O-ring material used in your instrument is compatible with the gas to be measured.** The O-ring material used in your Smart-Trak 2 can be found in the Data Label. See Appendix A for a table of elastomer compatibility with a wide variety of gases.
2. **Sierra strongly recommends you install an in-line filter upstream of the instrument.** Recommended filter size: 10 micron. A 10 micron filter is available from Sierra as an accessory. See Appendix B or contact your local Sierra distributor.
3. **Do not locate the instrument in areas subject to sudden temperature changes, excessive moisture or near equipment radiating significant amounts of heat.** Be sure to allow adequate space for cable connectors and wiring.
4. **For controllers, use a properly sized pressure regulator.** Make sure the pressure regulator is not too small or too big. There can be no restrictions (such as valves, tubing or pipe internal diameters, reducers, etc.) upstream or downstream of the controller with a dimension that is less than the valve orifice diameter. To determine orifice diameter, consult the calibration certificate included with your instrument. If restricted, controller will not reach full scale.
5. **Output Signals:** The Smart-Trak 2 has two analog outputs that are linearly proportional to the gas mass flow rate, one voltage and one current. Choose from 0-20 mA or 4-20 mA for current plus one voltage signal: 0-5 VDC or 0-10 VDC or 1-5 VDC. The output signals specified at time of order will be indicated on the data label. You may change among the current and the voltage output signal at your discretion after receipt of the instrument using the Pilot Module or the Smart-Trak 2 Software (see Chapters 4 & 5). Changing the output signals has no influence on the instrument's accuracy.
6. **The CAT-5** connector on the side of the Smart-Trak 2 is NOT an Ethernet connector. It is for use with the optional Remote Pilot Module. Do not plug an Ethernet cable here as damage may result. Keep this connector covered if possible whenever it is not in use.
7. **The instrument has specific power supply requirements.** See the table later in this chapter for a complete listing of power requirements.

Installing the Instrument—Plumbing

Smart-Trak 2 instruments are supplied with compression, VCO[®], VCR[®], or female NPT process connections. To ensure a successful installation, inlet and outlet tubing

should be clean prior to plumbing the instrument into the system. The shipping caps covering the inlet/outlet fittings should not be removed until immediately before installation.

Follow the installation instructions that are applicable to your instrument's process connection. Ensure that the tubing is free from burrs or sharp rims that may result from cutting.



CAUTION: Before use, all plumbing should be checked carefully for leaks, especially at the connecting fittings. All instruments are leak-tested prior to shipping. It is not a requirement to leak test your instrument. Do not use liquid leak detectors such as Snoop® to search for leaks inside or outside the Smart-Trak 2. Instead, monitor pressure decay.

Compression Fittings

1. Position the instrument with the flow direction arrow pointing in the direction of flow.
2. Verify the position of the front and back ferrule. Insert the tubing into the fitting. Be sure that the tubing rests firmly on the shoulder of the fitting and that the nut is finger-tight. Scribe the nut at the six o'clock position.
3. While holding the fitting body steady with a backup wrench, tighten the nut 1-1/4 turns, watching the scribe mark make one complete revolution and continue to the nine o'clock position. For 1/16-inch, 1/8-inch and 3/16-inch (2, 3 and 4 mm) sizes, tighten only 3/4 turns from finger-tight. **Do not over-tighten!**
4. If you use flexible tubing (Example: Polyflow) use an "Insert" (see www.swagelok.com)
5. Check the system's entire flow path thoroughly for leaks. **Do not use liquid leak detectors.** Instead, monitor pressure decay. Exposing the instrument to leak detector fluid may cause damage.

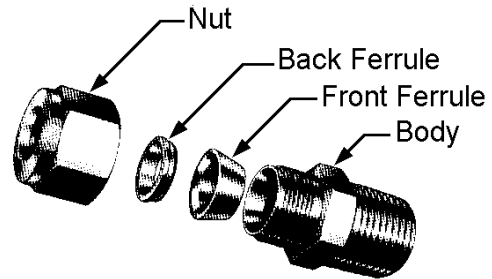

VCO Fittings

1. Position the instrument with the flow direction arrow pointing in the direction of flow.
2. Tighten the nut finger-tight, and then 1/8 turn tighter with a wrench. **Do not over-tighten!**

3. Check the system's entire flow path thoroughly for leaks. **Do not use liquid leak detectors.** Instead, monitor pressure decay. Exposing the instrument to leak detector fluid may cause damage.

VCR Fittings

1. Position the instrument with the flow direction arrow pointing the direction of flow.
2. Install new gaskets that are compatible with the gas to be used.
3. Tighten the nut finger-tight, and then 1/8 turn tighter with a wrench. **Do not over-tighten!**
4. Check the system's entire flow path thoroughly for leaks. **Do not use liquid leak detectors.** Instead, monitor pressure decay. Exposing the instrument to leak detector fluid may cause damage.

1/4 Inch Female NPT

1. Position the instrument with the flow direction arrow pointing the direction of flow.
2. Apply high quality Teflon tape to the male NPT fitting. Alternatively, use a high quality paste pipe thread sealant suitable for the application and gas, and apply this compound to the inlet and outlet fittings. Avoid getting the tape or the thread sealant onto the first two threads to keep it out of your process gas.
3. Tighten each fitting by hand. Then, tighten no more than one (1) turn. **Do not over-tighten.**
4. Check the system's entire flow path thoroughly for leaks. **Do not use liquid leak detectors.** Instead, monitor pressure decay. Exposing the instrument to leak detector fluid may cause damage.

Installing your Instrument—Mechanical Mounting

Mounting your Instrument

The base plate or bottom of the instrument has 4 mounting holes. Two are SAE thread and two are metric thread. For location and dimensions, please see Appendix E.

Your Smart-Trak 2 instrument is made from premium 316 stainless steel. As a result, it may require substantial mounting brackets to properly support its weight. Exercise caution when installing to avoid damage or injury.

Mounting the Optional Remote Pilot Module

If you have the optional Remote Pilot Module control unit, you have several mounting options.

1. **Wall or Panel mounting**—your Remote Pilot Module may be mounted to a flat surface using the supplied plate and 2 special “shoulder” screws. Simply screw the shoulder screws into the plate. Then, attach the plate to the wall by driving 2 screws (not included) through the 2 large central holes. **MAKE SURE THE UP ARROW IMPRINTED ON THE MOUNTING BRACKET POINTS UPWARD.** Your Remote Pilot Module will slip onto the shoulder screws. Push against the plate and then down. To remove, push up and pull. Attach the CAT-5 cable to the socket on the bottom of the Remote Pilot Module.
2. **Rack mounting**—to mount your Remote Pilot Module to a standard 19” laboratory rack, first purchase a “blank” panel from your industrial supplier. Decide where the Remote Pilot Module will be attached, then follow the procedure listed above for wall mounting. When you are ready, insert the CAT-5 cable into the socket in the Remote Pilot Module.
3. **Desktop mounting**—the Remote Pilot Module will sit on a desk in a fashion that makes it convenient to view and operate. Insert the CAT-5 cable into the socket in the back of the Module. Use the cable as a “kickstand.” Gently bend the cable to recline the Remote Pilot Module to an angle suitable for easy viewing. Alternately, you can lay the Remote Pilot Module on its back and insert the CAT-5 cable into the socket in the bottom.

Installing your Instrument—Electrical Connections

All electrical connections for your Smart-Trak 2 instrument are made on the left (inlet) side panel. See Figure 2-2: Smart-Trak 2 Connections below for the location of all connections. **Note that the CAT-5 connector is not an ethernet connector.**

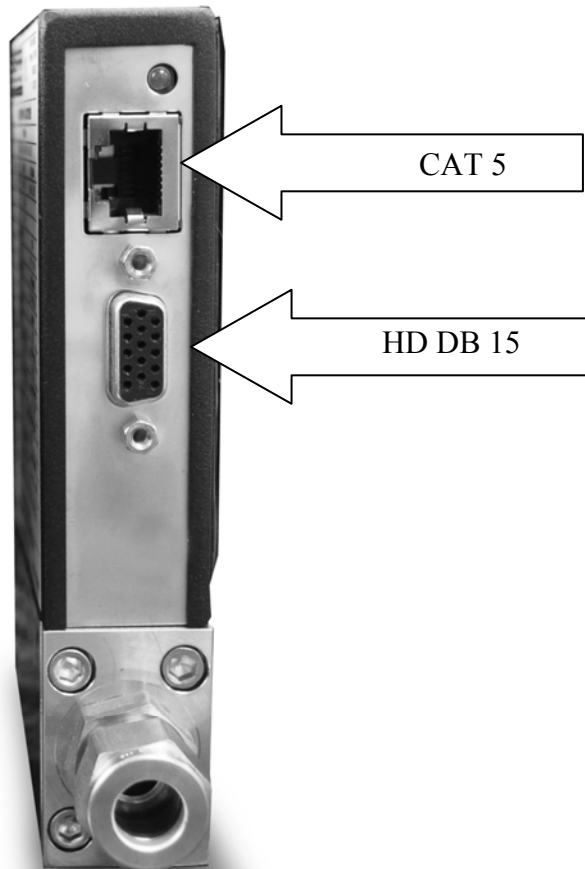
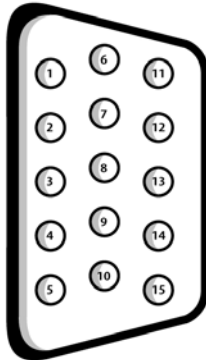

Figure 2-2: Smart-Trak 2 connections

Smart-Trak 2 is provided with a high density 15-pin D Connector called an “HD DB-15” located on the side of the enclosure and either one of our optional pre-assembled communications cables or an empty mating connector. Power must be supplied to the HD DB-15 connector. Other features may be accessed there as well. The pin numbers and assignments for the HD DB-15 connector are shown in Figure 2-3: HD DB-15 Connector Pin Configuration (on the instrument). The corresponding colors of the optional communication cable wires and the functions of each are listed in Figure 2-4: Wiring Definitions for Optional Communication Cable. The connections for input power, analog output signal and analog input signal (controllers only) are all made at the HD DB-15 connector. There is a second copy of these 2 figures in Appendix D for your convenience

Figure 2-3: HD DB-15 Connector Pin Configuration (on the instrument)**Figure 2-4: Wiring Definitions for Optional Communication Cable**

Pin #	Wire Color in Cable	Function
1.	Brown	Analog Ground/ Output
2.	Red	0-5 VDC Output (or 0-10, 1-5 VDC)
3.	Orange	Analog Ground/ RS232
4.	Pink	Valve Override Purge
5.	Yellow	Power Return (-)
6.	Green	Power Input (+)
7.	Green/White	RS-232 Transmit (out)
8.	Blue	Setpoint
9.	Purple	Not Used
10.	Gray	Analog Ground/ Setpoint
11.	White	Reference Voltage (5 VDC External Setpoint & Valve Purge)
12.	Black	Valve Override Close
13.	Brown/white	RS-232 Receive (in)
14.	Red/white	4-20 mA Output
15.	Red/Black	Not Used
	Shield Wire (no insulation)	Chassis (Earth) Ground

Note: Pins 1, 3, and 10 are connected together inside the instrument. Do not tie these grounds together outside the instrument. Must have one connection per analog ground. Recommended use listed.

Instrument Power:

The Smart-Trak 2 requires a 15-24 VDC power supply. If you are using the power supply supplied by Sierra, connect it to the 15-pin HD DB-15 connector on the side of the instrument. If you are supplying your own power source, it must be a regulated 15-24 VDC with ripple not to exceed 100 mV peak-to-peak. It must be capable of producing the current specified for the appropriate voltage shown in Figure 2-5: Power Supply Requirements. Apply power as follows: positive (+) to the green (pin 6) and negative (-) to the yellow (pin 5) wires. The instrument is polarity sensitive. If you reverse this wiring, the instrument will not be damaged, but it will not function.

Instrument Grounding:

The Smart-Trak 2 has very high levels of RFI and EMI shielding built into the metal electronics cover (meets or exceeds the CE Standard EN 61326-1; 2006). To maintain the integrity of this CE rating, it is critical that a path be provided for any residual internal noise to exit the instrument or it may register on the outputs. Grounding provides this path.

To properly ground your instrument, secure the chassis to solid earth ground using the mounting holes on the bottom of the flow body. If the instrument will be used without permanent mounting (on a laboratory bench, for instance) then, using the provided cable, connect the shield wire (no insulation) to earth ground in your facility. If you purchased a Sierra power supply, a ground wire is provided for your convenience.

Figure 2-5: Power Supply Requirements

Instrument Type	Recommended Input Voltage	Minimum Current Required (mA)
M100L Meter	15-24 VDC ($\pm 10\%$)	130
M100M Meter	15-24 VDC ($\pm 10\%$)	130
M100H Meter	15-24 VDC ($\pm 10\%$)	130
C100L Controller	24 $\pm 10\%$ VDC*	400
C100M Controller	24 $\pm 10\%$ VDC	700
C100H Controller	24 $\pm 10\%$ VDC	1260



CAUTION: This instrument is not a loop-powered device! Do NOT apply power to the 4-20 mA output or input connections.

Analog Output Signals:

- **Output Signal—Voltage:** Measure the voltage output signal across the red (pin 2) wire and any of the analog grounds: brown (pin 1), orange (pin 3) or gray (pin 10). The minimum load is 1000 Ohms. We recommend pin 1. **DO NOT USE THE SAME ANALOG GROUND FOR CURRENT OUTPUT, SETPOINT OR RS232.**
- **Output Signal—Current:** Measure the current output signal, 4-20 mA or 0-20 mA, across the red/white stripe (pin 14) wire and any of the analog grounds: pin 1, 3, or 10. The maximum load is 500 Ohms. We recommend pin 1. **DO NOT USE THE SAME ANALOG GROUND FOR VOLTAGE OUTPUT, SETPOINT OR RS232.**

For Mass Flow Controllers, the following analog features are also available at the HD DB-15 connector:

- **Setpoint:** To transmit an analog setpoint, supply the voltage or current signal (check the data label and/or setting) across the blue (pin 8) wire and pin 10.
- **Valve Close:** To force the valve closed, connect the black (pin 12) wire to pin 10
- **Purge:** To force the valve to its maximum open position which we call “Purge,” connect the pink (pin 4) wire to the white (pin 11) wire. Note that this will allow much greater flow than the rated full-scale value.

For Digital Communication Using Your Personal Computer:

You can communicate with your instrument using the Smart-Trak 2 Software package and your PC running the Windows operating system. Simply connect the light green (pin 7) wire, the brown/white stripe (pin 13) wire and one of the analog grounds (pin 1,3, or 10) to a standard DB-9 connector according to Figure 2-6: Digital Communication.

Figure 2-6: Digital Communication

RS-232 Transmit (pin 7)	to	DB-9 pin #2
RS-232 Receive (pin 13)	to	DB-9 pin #3
Analog ground (pin 3)	to	DB-9 pin #5



NOTE: Transit and Receive may need to be reversed, depending on which type of device or cable is connected. (No damage will result—attempt communication after reversal.)

With the connections in Figure 2-6 in place, plug the DB-9 connector into an appropriate serial port on your PC.

To minimize the potential for RF interference, it is recommended to shield these wires. Use a metal DB-9 connector and connect one end of the shield to the DB-9 shell and the other end to the outer shell of the Smart-Trak 2 HD DB-15 connector.



CAUTION: The CAT-5 connector on the side of the Smart-Trak 2 is NOT an Ethernet connector. It is for use with the optional Remote Pilot Module or CRN cable. Do not plug an Ethernet cable here as damage may result.

CHAPTER 3: ANALOG OPERATION

Your Smart-Trak 2 instrument may be operated in three different ways:

THREE CONTROL OPTIONS

- A. **Analog Input/Output Operation (This Chapter):** Using analog input/output signals at the 15-pin mini-D connector.
- B. **Digital Operation with Pilot Module (Chapter 4):** Using the optional Pilot Module.
- C. **Digital Operation with RS-232 and Smart-Trak 2 Software (Chapter 5):** Using the RS-232 link, the supplied Smart-Trak 2 Software package, and a PC-style computer running Windows operating system.

This chapter will discuss the first of these—Analog Operation. Please see subsequent chapters for other options.

Regardless of control options, the standard output for all Smart-Trak 2 instruments are two linear analog output signals corresponding to 0% to 100% of the mass flow full-scale range. Please note that one of these output signals is a current signal of either 4-20 or 0-20 mA. The other is a voltage signal of 0-5 VDC, 0-10 VDC or 1-5 VDC. You can choose any combination of these signals at any time in your facility.

For mass flow controllers, one input signal of 4-20 mA, 0-20 mA, 0-5 VDC, 0-10 VDC or 1-5 VDC (selectable by user) may be chosen to set the gas mass flow rate to any desired value within the range of the device. This input signal must be a direct linear representation of 0% to 100% of the desired gas mass flow full-scale value. For the location of these signals on the HD DB-15 connector, refer to Figure 2-4 or Appendix D.

Analog Operation, Mass Flow Meter

After your instrument is installed and the system has undergone a complete leak check as discussed in detail in Chapter 2, you are ready to supply power.

Power Your Instrument: Provide adequate power per Figure 2-5. Apply power using Sierra's power supply or your own power source. The green LED at the top of the inlet side will light to confirm power. If your instrument has a Pilot Module, it will begin its start-up cycle. See Chapter 4 for details on Pilot Module operation. **NOTE:** It is highly recommended you connect power to the Smart-Trak 2, and then power your supply (plug into wall or switch on). The opposite may cause the unit to take longer to power on. Let the instrument warm up for at least 15 minutes for optimal performance.

Your Smart-Trak 2 instrument is now ready for use!

Analog Operation, Mass Flow Controller

After your instrument is installed and the system has undergone a complete leak check as discussed in detail in Chapter 2, follow these steps:

1. **The valve will remain closed until power is supplied.** See Chapter 2 for wiring instructions. Remember that the valve in the Smart-Trak 2 is not a positive shut-off device. When power is applied, the flow control valve will operate per any instructions it receives. When the Smart-Trak 2 is delivered, the valve will be in the Automatic (Normal) state and the Pilot Module or analog signal will provide the correct zero setpoint reference for the instrument. As a result, the valve will be closed. However, upon subsequent power-ups, the valve will return to the state it was in the last time the instrument was operated.



CAUTION: If you do not know the value of the setpoint or the valve state given to the Smart-Trak 2 when it was last operated, you must assume that the valve will open when power is applied. Take necessary precautions. You may use the Pilot Module or the Smart-Trak 2 Software to check the setpoint or the valve state currently on your instrument. See Chapter 4 or Chapter 5 for information on Setpoint and Valve State.

2. **Power Your Instrument:** Provide adequate power per Figure 2-5. Apply power using Sierra's power supply or your own power source. The green LED at the top of the inlet side will light to confirm power. If your instrument has a Pilot Module, it will begin its start-up cycle. See Chapter 4 for details on Pilot Module operation. **NOTE:** It is highly recommended you connect power to the Smart-Trak 2, and then power your supply (plug into wall or switch on). The opposite may cause the unit to take longer to power on. Let the instrument warm up for at least 15 minutes for optimal performance.
3. **Adjust the controller setpoint to the desired flow rate by supplying an appropriate signal (mA or VDC).** The effective control range of the unit is 2% to 100% of the calibrated full scale flow range. Automatic shut-off occurs at 1.9% of the factory full scale calibrated range unless specifically modified at time of order. Smart-Trak 2 will immediately begin accurately monitoring and controlling the gas mass flow rate. Let the instrument warm up for at least 15 minutes for optimal performance.

Your Smart-Trak 2 instrument is now ready for use!

Smart-Trak 2 Features

Setpoint Adjustment

The setpoint (command) input signal you supply to Smart-Trak 2 must be a direct linear representation of 0% to 100% of the mass flow full-scale value. Apply the setpoint signal from pin 8 to any of the analog grounds (see Chapter 2 for wiring details). A setpoint value of 0 VDC or mA (or 1 VDC or 4 mA) will regulate the flow to 0% and a setpoint value of 5.00 VDC (or 10 VDC or 20 mA) will adjust the flow to 100% of the instrument's full scale range.

When the setpoint (command) signal is applied, the flow controller will reach the setpoint value within two seconds to within $\pm 2\%$ of the selected flow rate.



CAUTION: DO NOT LEAVE A SETPOINT APPLIED FOR AN EXTENDED PERIOD OF TIME TO A CONTROLLER WHEN THE GAS SUPPLY IS SHUT OFF OR BLOCKED. Damage may result and the instrument will become hot to the touch. Instead, see below for use of the “Valve Close” feature which allows you to disable the valve while maintaining the setpoint signal. This may be set by the Pilot Module, the Smart-Trak 2 Software, or an external analog signal.

Changing the Output or Setpoint Signals

To modify the analog output or setpoint signals (from 4-20mA to 0-10Vdc, for example), you must use the Pilot Module or the Smart-Trak 2 Software. The data label will indicate the form these signals had when the instrument was last calibrated. We strongly recommend that you adapt the data label if the configuration is changed for future reference. See Chapter 4 or 5 for the necessary procedure.

Over-Range Condition

If the mass flow rate exceeds the full-scale range listed on the Smart-Trak 2 data label (see samples on page 2-1), the output signal will measure above full-scale. However, the device has not been calibrated for flows in excess of the calibrated full scale value and the value will be both non-linear and inaccurate if an over-range condition exists. Please be aware that the analog outputs can exceed full scale by as much as 20%, or more.

Once the over-range condition has been removed, it may take up to 30 seconds for the Smart-Trak 2 to recover and resume normal operation. An over-range condition will not harm the instrument.

Manual Valve Override—Valve Close

Manual valve override is provided for all Sierra mass flow controllers. This feature includes both a valve close command and a valve maximum open command (called purge). When the valve is directed to close or to purge, it will no longer respond to a setpoint command.

FOR VALVE CLOSE: connect pin 12 to analog ground

Remember that the valve in the Smart-Trak 2 is not a positive shut-off device. The Controller will return to normal automatic operation about 4 seconds after pin 12 is left floating.

Manual Valve Override—Valve Purge Function

The purge function opens the controller valve completely for the purpose of quickly flushing unwanted gas from the flow path. When the valve is opened for purging, it allows flows far in excess of the rated full scale of the controller.

FOR VALVE PURGE: connect pin 4 to pin 11.



CAUTION: PURGE MODE ALLOWS FAR MORE GAS TO FLOW THROUGH THE CONTROLLER! BEFORE USING VALVE PURGE OPERATION, INSURE PROPER DOWNSTREAM CAPACITY AND VENTILATION.

Caution!

IMPORTANT NOTES ABOUT PURGING

Purging Non-Reactive Gases:

Purge your Smart-Trak 2 with clean, dry nitrogen for a minimum of two hours.

Purging Reactive Gases:

One of the following methods may be used:

- ❖ Cycle purge. This is done by alternately evacuating and purging the instrument for 2 to 4 hours with clean, dry nitrogen.
- ❖ Purge the instrument with clean, dry nitrogen for 18 to 24 hours.
- ❖ Evacuate the instrument for 18 to 24 hours.

IMPORTANT SAFETY NOTES ABOUT PURGING



WARNING: When toxic or corrosive gases are used, purge unit thoroughly with inert dry gas before disconnecting from the gas line to prevent personnel from being injured when coming in contact with the instrument.



WARNING: If an instrument used with a toxic or corrosive gas is returned to the factory, a Material Safety Data Sheet (MSDS) must be enclosed & attached to the outside of the box to alert Sierra personnel of the potential hazard. Also, make sure the inlet & outlet are securely sealed.

CHAPTER 4: Digital Operation with Pilot Module

Your Smart-Trak 2 instrument may be operated in three different ways:

THREE CONTROL OPTIONS

- A. **Analog Input/Output Operation (Chapter 3):** Using analog input/output signals at the HD DB-15 connector.
- B. **Digital Operation with Pilot Module (This Chapter):** Using the optional Pilot Module.
- C. **Digital Operation with RS-232 and Smart-Trak 2 Software (Chapter 5):** Using the RS-232 Smart-Trak 2 Software package and a computer running the Windows operating system.

This chapter will discuss the second of these—Digital Operation with the optional Pilot Module. Please see alternate chapters for other options.

Although you have chosen to use the optional Pilot Module, please note that all the Analog control functions are still available on your instrument. Consult Chapter 3 for details on Analog operation. Also, computer control using the RS-232 communication is available. See Chapter 5 for details on operation with a computer.



CAUTION—If RS-232 digital communication is to be used in conjunction with the Pilot Module, the HD DB15 connector must be properly wired with a three wire serial DB9 cable to your computer. Often, this is done with the same HD DB15 that supplies power to your instrument. You can run both RS-232 communication and Pilot Module communications in parallel, but the unit will only respond to one set of commands at a time. **DO NOT** attempt to control the unit simultaneously with both the Pilot Module and the computer, this can lock up the unit.

Introduction to Pilot Module Features and Capabilities

The optional Pilot Module functions as both display and a control unit for your Smart-Trak 2 instrument. The standard Pilot Module is available mounted directly on the face of your instrument or as a handheld / remote mountable control interface attached to the Smart-Trak 2 via a detachable cable.

If your instrument has a standard Pilot Module mounted locally on the face of the unit, no additional set-up is required. See picture below.



On the other hand, if your instrument has a Remote Pilot Module, attach one end of the included Category 5 (CAT 5, also called RJ-45) connecting cable into the jack at the top of the instrument's left side, immediately above the HD DB-15 connector. Next, place the other end into one of the two matching jacks on the Pilot Module. For your convenience, Sierra has provided two jacks—one on the back and one on the bottom of the Remote Pilot Module. You may use whichever jack is most convenient for your application as they both have identical functions.

The Pilot Module includes a large LCD graphic display screen and six buttons. The LCD will show a variety of information and the buttons can be used to view and modify this information. The convenient buttons are:

- Left arrow
- Right arrow
- Up arrow
- Down arrow
- Enter button
- Escape button

These are shown in the photo below:

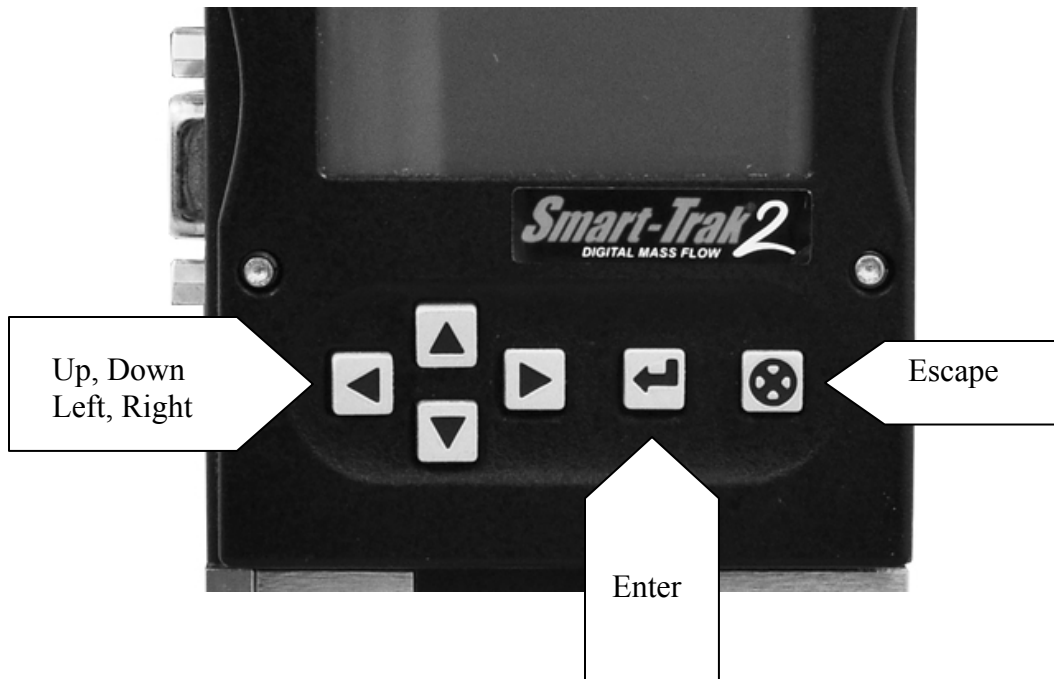

Pilot Module Operation, Mass Flow Meter

After your instrument is installed and the system has undergone a complete leak check as discussed in detail in Chapter 2, follow these steps:



Caution!

The Smart-Trak 2 is not a loop-powered device. Do not apply power to the 4-20 mA outputs.

- 1. Power Up Your Instrument:** Apply power to your instrument. See Chapter 2, Figure 2-5: Power Supply Requirements. When power is first applied, the Pilot Module will display:

Version
2.04X
Read Parameters

Assuming no gas is flowing, after another 5-10 seconds the display will read:

Mass Flow
0.000 sl/m

Air

NOTE: If gas is flowing the Pilot Module will immediately begin to accurately display the gas mass flow rate on the LCD panel. If you have chosen alternate units or another gas, the display will show the selected units instead of the above.

2. **Open the gas supply:** Smart-Trak 2 is now ready to monitor the gas mass flow rate. Let the instrument warm up for at least 15 minutes for optimal performance.

Your Smart-Trak 2 instrument is now ready for use!

Pilot Module Operation, Mass Flow Controllers

After your instrument is installed and the system has undergone a complete leak check as discussed in detail in Chapter 2, follow these steps:

1. **The valve will remain closed until power is supplied.** See Chapter 2 for wiring instructions.



CAUTION: Remember that the valve in the Smart-Trak 2 is not a guaranteed positive shut-off device. For dangerous applications, Sierra recommends use of an external shut-off safety valve.

When power is applied, the flow control valve will operate per the instructions it receives from the Pilot Module. When the Smart-Trak 2 is delivered, the valve will be in the Automatic (Normal) state and the Pilot Module will provide the correct zero setpoint reference. As a result, the valve will be closed. However, the valve will return to the state it was in the last time the instrument was operated.



WARNING: If you do not know the setpoint or the valve state of the Mass Flow Controller before it was shut down, you must assume that the valve will open when power is applied. *TAKE NECESSARY PRECAUTIONS.*

2. **Power Up Your Instrument:** Apply power to your instrument using Sierra's power supply or your own input power source. See Chapter 2, Figure 2-5: Power Supply Requirements. When power is first applied, the Pilot Module will display:

Version

2.04X

Read Parameters

If no gas is flowing, after another 5-10 seconds the display will read:

Mass Flow
0.000 sl/m
Air

NOTE: If gas is flowing and the Pilot Module has a setpoint greater than zero, it will immediately begin to accurately display the gas mass flow rate on the LCD panel. If you have chosen alternate units or another gas, the display will show the selected units instead of those above.

3. **Open the gas supply.** Smart-Trak 2 is now ready to monitor and control the gas mass flow rate. The display will show 0.000 until it is given a setpoint. Let the instrument warm up for at least 15 minutes for optimal performance.

Your Smart-Trak 2 instrument is now ready for use!



CAUTION: DO NOT LEAVE A SETPOINT APPLIED FOR AN EXTENDED PERIOD OF TIME TO A CONTROLLER WHEN THE GAS SUPPLY IS SHUT OFF OR BLOCKED. Damage may result and the instrument will become hot to the touch. Instead, see below for use of the “Valve Close” feature which allows you to disable the valve while maintaining the setpoint signal. This may be set by the Pilot Module, the Smart-Trak 2 Software, or an external analog signal.

Using the Pilot Module Menus & User Interface

The features of the Pilot Module can be considered in three groups:

- 1 **Upper Level Screens:** display information (no password is required to view this information). These include:
 - ❖ Mass flow rate
 - ❖ Gas (10 options pre-programmed)
 - ❖ Engineering units (mass per unit time)
 - ❖ Current Setpoint with units
 - ❖ Source of Setpoint (analog or digital and type)
 - ❖ Valve operation mode (normal, valve close or purge)
 - ❖ Current meter full scale value with units (user selectable)

-
- 2 **Lower Level Screens:** permit changes to instrument operation. They are password protected. These include:
- ❖ Setpoint value
 - ❖ Engineering units
 - ❖ Gas
 - ❖ Valve operation
 - ❖ Source of the setpoint signal
 - ❖ Form of the output signals
 - ❖ Full scale of the instrument
 - ❖ Password
 - ❖ Zero
 - ❖ Span
- 3 **Maintenance Features:**
- ❖ Re-boot the Smart-Trak 2 microprocessor

Map of the Pilot Module Interface

The Pilot Module user interface is presented below in a graphical format. Once you have some familiarity with the user interface, you may find you want to make a copy of this and keep it with the instrument for reference. You can find a larger version of this Flow Chart in Appendix C.

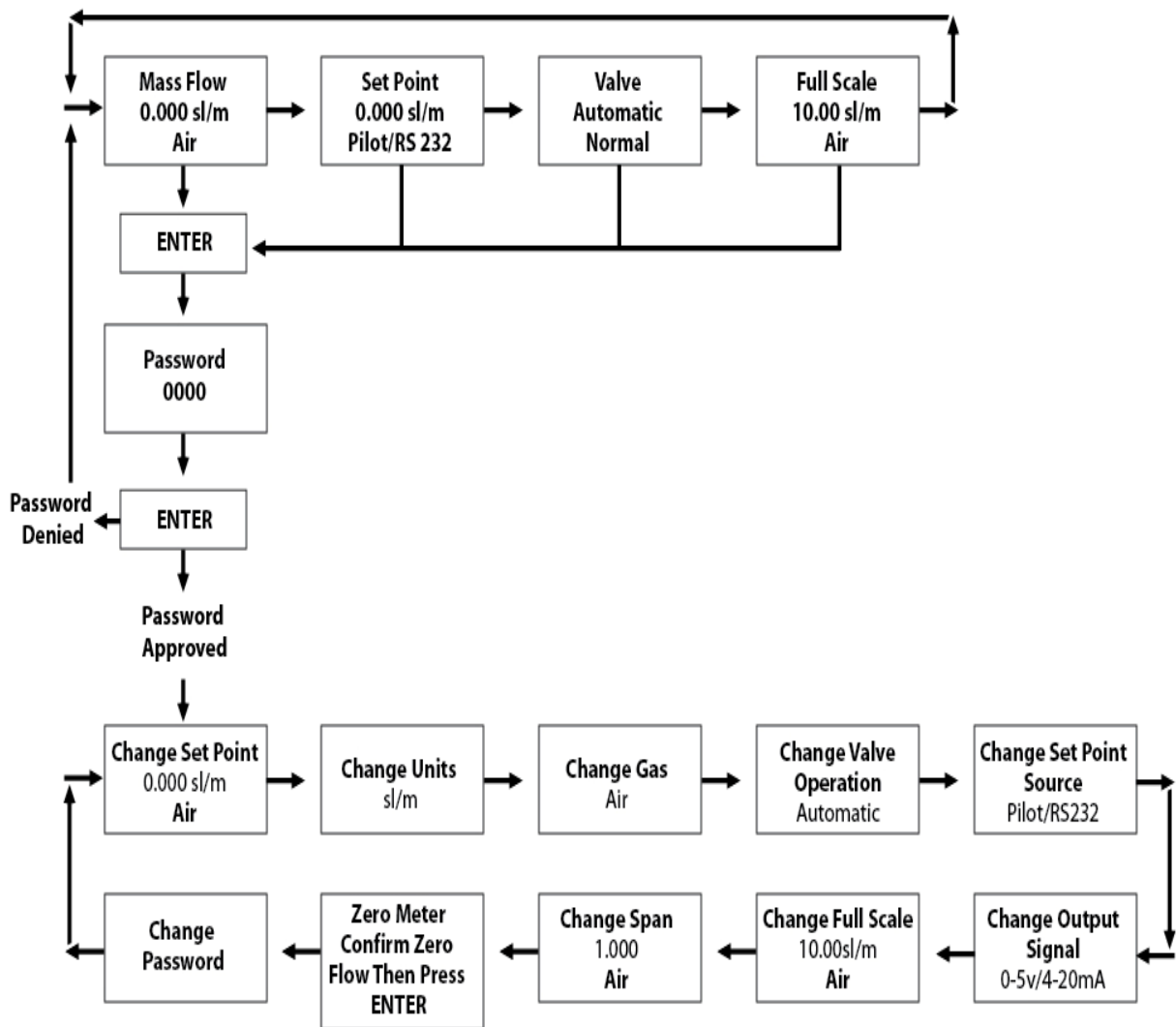

The four **Upper Level Screens** display a variety of information. You are able to move between the screens by pressing the left or right arrows. No password is required for the Upper Level Screens.

Mass Flow Screen

When the instrument is powered up, or whenever the escape button is pressed, it always returns to the Mass Flow Screen. This screen displays the mass flow rate, the engineering units and your gas choice. It looks something like this:

Mass Flow
0.000 sl/m
Air

Setpoint Screen

Pushing the right arrow takes you to the Setpoint Screen. The Setpoint Screen displays the current setpoint given to the controller, the engineering units and the source of the setpoint signal.

The source of the setpoint can be:

- Pilot Module/RS-232
- 4-20 mA
- 1-5 Vdc
- 0-5 Vdc
- 0-10 Vdc

For operation with the Pilot Module, the display will look something like this:

Setpoint
10.00 sl/m
Pilot Module/RS-232

If this screen does not show “Pilot Module/RS-232” at the bottom, you will not be able to give the controller a setpoint command from the Pilot Module because the instrument is waiting for an analog setpoint. See section below titled “Change Setpoint Source Screen” to change the source of the setpoint signal. Alternately, you may supply an analog setpoint to the HD DB-15 connector (see Chapter 3).

Valve Position Screen (Mass Flow Controllers only)

Pushing the right arrow again takes you to the Valve Position Screen, if you have a Mass Flow Controller. This screen will display the current state of the Smart-Trak 2 valve.

The state of the valve can be:

1. Closed (Remember that the Smart-Trak 2 is not a positive shut-off device).
2. Purge--Maximum Open (recommended 120% of the calibrated full scale value, but can be much more and can be dangerous)
3. Automatic (the normal position, where the controller responds to a setpoint signal).



WARNING: The flow rate in Purge is much greater than the calibrated full scale value and as a result can be dangerous.

For normal operation of the flow controller, this screen should display:

**Valve
Automatic
Normal**

If this is visible, the instrument will automatically control flow as soon as a setpoint is given to it. If this screen displays Closed or Purge, the instrument has been placed into an override position and it will not respond to any setpoint signal. The valve state may be changed using the “Change Valve Operation” as described on page 4-16.

Full Scale Screen

Pressing the right arrow again takes you to the Full Scale Screen. This screen displays the current full scale value of the instrument with engineering units. It also displays the gas. Note that this is not necessarily the factory calibrated full scale value. The screen will display:

**Full Scale
10.00 sl/m
Nitrogen**

To change the full scale value, see the section below titled “Change Full Scale Screen.” Pressing the right arrow again takes you back to the Mass Flow Screen.

Lower Level Screens (Changing Parameters)

Getting to the Lower Level Screens:

Your instrument is password protected so that unauthorized personnel will be unable to change the operating parameters of Smart-Trak 2. To enter the Lower Level Screens at any time you must first supply the correct password.

Password Screen: By pressing the “enter” key from any of the Upper Level Screens you will come to the Password Screen. (If you do not know if you are in an Upper Level Screen, press escape and you always automatically go to the Mass Flow Screen in the Upper Level) The display will show:

Enter Password
0000

The first digit will blink. At this point, you must enter the correct password to gain access to the Lower Level Screens.

- ✓ **If the instrument is being operated for the first time or if no password has ever been set on the instrument:** You can use the factory default password. The factory default password is “0000.” To proceed to the Lower Level Screens by using the factory default password, simply press the “enter” key a second time. If you want rapid access to permit regular changes to your instrument and you do not desire a password, this is the fastest way to enter the lower level.
- ✓ **If You Have a Password:** If you have already set a password, enter it now. To enter the password, push the up arrow to increase the blinking digit or the down arrow to decrease the blinking digit. To move to the next digit, press the left or right arrow and repeat the process. When you have selected your four digit password, press the enter key.
- ✓ **If You Want to Set a New Password:** If you want to change the password, you must first get to the Lower Level Screens. Proceed by entering your known password or if no password has ever been set on the instrument, use the factory default password. Follow the instructions in the “Change Password Screen” section found later in this chapter.

If the password you have entered is correct, you will enter the Lower Level at the Change Setpoint Value Screen.

If the password is not correct, the display will show:

Access Denied
Press any button
To continue

When you press any button, you will return to the Mass Flow Screen in the Upper Level. Press the “enter” key to try again.

LOST PASSWORDS & GENERAL CUSTOMER SERVICE: If you lose your password, it will be necessary to contact one of Sierra’s Technical Support Centers.

Email Customer Service: service@sierrainstruments.com

FACTORY USA Customer Service:

TOLL FREE: 800-866-0200

PHONE: 831-373-0200

FAX: 831-373-4402

EMAIL: service@sierrainstruments.com

European Customer Service:

PHONE: +31 72 5071400

FAX: +31 72 5071401

EMAIL: service@sierra-instruments.nl

Asia Customer Service:

PHONE: + 8221 5879 8521

FAX: +8621 5879 8586

EMAIL: www.sierra-asia.com

Making Changes Using the Lower Level Screens:

The eight Lower Level Screens are at the heart of Dial-A-Gas, allowing you complete control of your Smart-Trak 2 instrument. It is possible to make several changes on different Lower Level Screens before exiting.

For example, you could change between one of the ten pre-programmed gases, change the engineering units, and change the setpoint all in one visit to the Lower Level Screens. The Smart-Trak 2 will make each adjustment as you complete it. At any time, you may press the escape button to return to the Upper Level.

Change Setpoint Value Screen

This screen is the entry point to the Lower Level. As soon as a correct password is entered, you will arrive here. If you are already in the Lower Level Screens, push the right or left arrow until you reach the Change Setpoint Value screen. The display will show:

Change Setpoint
00.00 sl/m
Air

This is the position where you can change the setpoint value of the mass flow controller. To make a change to the displayed value, press the enter key. The first number in the display will blink. Use the up and down arrows to change the value of this digit or the left and right arrows to move to another digit. For example, if you wish to enter a setpoint of 12.5 sl/m, push the “up” arrow once when the first digit is blinking. You will see:

Change Setpoint
10.00 sl/m
Air

Next, press the “right” arrow so that the second digit blinks. Push the up arrow twice. You will now see:

Change Setpoint
12.00 sl/m
Air

Press the right arrow again. The first digit after the decimal point will now blink. Press the up arrow 5 times until you see:

Change Setpoint
12.50 sl/m
Air

Now that you have made your selection, press the enter key. The display from our example will show:

Change Setpoint
12.50 sl/m
Air

If you are finished or wish to observe the changes you have made on the LCD panel, press the escape key to return to the Upper Level Mass Flow Screen.

If you prefer to make additional changes, use the left and right arrow keys to move to other Lower Level Screens.



Caution!

The Smart-Trak 2 will not allow you to enter a setpoint greater than the current full scale value set on the instrument.

Note: If you enter a Setpoint that exceeds the full scale value (displayed in the “Full Scale” screen in the Upper Level), the Smart-Trak 2 will automatically modify this value to equal the current full scale value. For example, if the current full scale value of your instrument is 10 slpm and you have entered a setpoint of 15 slpm, the Smart-Trak 2 will modify your setpoint to 10 slpm when you implement the change. The Setpoint Value screen will show 10 slpm, not 15 slpm.

Change Units Screen

If you are already in the Lower Level Screens, push the right or left arrow until you reach the Change Units screen. To get to this screen at any time, Press Escape—Press Enter—type password and Press Enter. Then, press the Right or Left arrow until you reach the Change Units Screen.

The display will show:

Change Units
sl/m

If you wish to change the engineering units, press the enter button at this point. The “mass units” will begin to blink. Use the up or down arrows to select an alternate unit. You can choose from the following mass units:

sl
NL
g
kg
lb
scc
Ncc
SCF
NM³
SM³

When you are satisfied, push the left or right arrow. You will now see the “time unit” blink. Use the up or down arrows to select your choice of time units. You can choose from the following time units:

m (minutes)
H (hours)
S (seconds)

When you are finished, press the enter button again. You will see:

Change Units
XXX/x

You can make additional changes by using the left and right arrow keys to move to other Lower Level Screens. You may also choose to press the escape key to return to the Upper Level Screens and to observe your change.



Change Gas Screen (Dial-A-Gas)

If you are already in the Lower Level Screens, push the right or left arrow until you reach the Change Gas screen. To get to this screen at any time: Press Escape—Press Enter—type password and Press Enter. Then, press the Right or Left arrow until you reach this screen. The display will show:

Change Gas
Nitrogen

If you wish to change the gas used in the instrument, press enter. The name of the gas will blink. Use the up and down arrows to make your selection. When you reach the desired gas, press enter. You will see:

Change Gas
XXXX

You can make additional changes by using the left and right arrow keys to move to other Lower Level Screens. You may also choose to press the escape key to return to the Upper Level Screens and to observe your change.

Note: your instrument comes with 10 pre-programmed standard gases. These are listed in the Specifications in Appendix B. Smart-Trak 2 may be ordered with alternate gases programmed. If your device was so ordered, you may choose from these 10 gases instead. You may see the 10 gases programmed in your instrument by using this screen and simply scrolling up or down.



Caution!
The Smart-Trak 2
valve is not a positive
shut-off device.

Change Valve Operation-Close, Purge

If you are already in the Lower Level Screens, push the right or left arrow until you reach the Change Valve Operation screen. To get to this screen at any time: Press Escape—Press Enter—enter password and Press Enter. Then, press the Right or Left arrow until you reach this screen. The display will show:

Change Valve
Operation
Automatic

From this screen you may set the valve to open all the way (“Purge”), force the valve to remain closed until further changes are made (“Valve Closed”) or set the valve to control flow when it receives a setpoint from some source (“Automatic”). To make a change to the valve operation, press the enter key. Use the up and down arrows to make your selection. When you are satisfied, press the enter key again. You will see:

Change Valve
Operation
XXXXX

You can make additional changes by using the left and right arrow keys to move to other Lower Level Screens. You may also choose to press the escape key to return to the Upper Level Screens.

Note: The valve will move to the desired position immediately when you press the enter key.

IMPORTANT SAFETY NOTES ABOUT PURGING



WARNING: When toxic or corrosive gases are used, purge unit thoroughly with inert dry gas before disconnecting from the gas line to prevent personnel from being injured when coming in contact with the instrument. Chapter 3 discusses how to purge your instrument. Always neutralize any toxic gas trapped inside the instrument before removing it from the gas line.



WARNING: The flow rate in Purge is much greater than the calibrated full scale value and as a result can be dangerous.

Change Setpoint Source Screen (mass flow controllers only)

If you are already in the Lower Level Screens, push the right or left arrow until you reach the Change Setpoint Source screen. To get to this screen at any time: Press Escape—Press Enter—enter password and Press Enter. Then, press the Right or Left arrow until you reach this screen. The Change Setpoint Source screen allows you to re-configure the location and type of the setpoint for the Smart-Trak 2 controller. If you intend to supply the setpoint command signal from the Pilot Module or a computer using the RS-232 link, the display must show:

**Change Setpoint
Source
Pilot/RS232**

If, instead of using the Pilot Module or the RS-232 link, you prefer to supply an analog setpoint signal to the Smart-Trak 2, press the enter button. “Pilot/RS232” will begin to blink. Use the up and down arrows to make your selection from the following choices:

0-5 VDC
0-10 VDC
1-5 VDC
4-20 mA
Pilot/RS232

When you are satisfied, press enter. You will see:

**Change Setpoint
Source
X-XX XX**

You can make additional changes by using the left and right arrow keys to move to other Lower Level Screens. You may also choose to press the escape key to return to the Upper Level Screens.



Caution: If you change the source of the setpoint to an analog value, you will not be able to control your Smart-Trak 2 mass flow controller via the Pilot Module or the RS-232 link.

Change Output Signals Screen

If you are already in the Lower Level Screens, push the right or left arrow until you reach the Change Output Signals screen. To get to this screen at any time: Press Escape—Press Enter—enter password and Press Enter. Then, press the Right or Left arrow until you reach this screen. The display will show:

**Change Output
Signals
0-5 VDC/4-20 mA**

Here you can re-configure the analog output signals for the instrument. The Smart-Trak 2 always outputs one current signal of 4-20mA but the voltage signal may be selected using this screen. Use the up and down arrows to make your selection. You can choose between:

0-5VDC and 4-20mA
0-10VDC and 4-20mA
1-5VDC and 4-20mA

When you are finished making your selection, press enter. The screen will read:

**Change Output
Signals
X-XX XX/X-XX XX**

You can make additional changes by using the left and right arrow keys to move to other Lower Level Screens. You may also choose to press the escape key to return to the Upper Level Screens.

Change Full Scale Screen

If you are already in the Lower Level Screens, push the right or left arrow until you reach the Change Full Scale screen. To get to this screen at any time: Press Escape—Press Enter—enter password and Press Enter. Then, press the Right or Left arrow until you reach this screen. The display will show:

**Change Full Scale
XX.XX sl/m
Air**

This screen allows you to re-range the outputs of your instrument. You may select any full-scale value between 100% and 50% of the displayed maximum value (this is the factory full-scale calibration value).

The new full-scale value that you select will re-define the analog outputs of the instrument. The 20 mA signal and the corresponding voltage signal (5 VDC, 1-5 VDC or 10 VDC) will now represent this new full-scale value.



Caution: Changing the full-scale value of the instrument does not affect the accuracy.

The accuracy is always $\pm 1\%$ of the original factory full-scale calibration value.



Caution: For any instrument, if a value greater than the factory full scale calibration value is entered on this screen, the Smart-Trak 2 will modify the requested value to equal the factory full scale calibration value.

If you choose to change the full-scale value, press the enter key. The first digit will blink. Use the up and down arrows to adjust the value of the digit or the left and right arrows to choose another digit. When you have completed your modification, press the enter key. The display will show:

**Change Full Scale
XX.XX sl/m
Air**

You can make additional changes by using the left and right arrow keys to move to other Lower Level Screens. You may also choose to press the escape key to return to the Upper Level Screens.

Change Span Screen

If you are already in the Lower Level Screens, push the right or left arrow until you reach the Change Span screen. To get this screen at any time: Press Escape—Press Enter—enter password and Press Enter. Then, press the Right or Left arrow until you reach this screen.

From this screen you can change the instrument's span distance by a percentage factor ratio. For example, if your meter is reading 1% high of reading, change span to 0.990 (99.0%) and the full scale value should be reduced by 1%. If your controller is controlling 1% below of reading, the same change will bring it in. If the meter is reading 1% low (controller controls 1% high), then change span to 1.010 (101.0%). The display will show:

Change Span
1.000
Air

To make a change, press the enter key. The first digit will begin to blink. Use the up and down arrows to modify this digit or the left and right arrows to choose another digit. When you are satisfied, press enter. The display will show:

Change Span
X.XXX
Air

Keep in mind that you can change the span for each individual gas, thus, a change in the span to one gas will not affect the span of another gas. You can make additional changes by using the left and right arrow keys to move to other Lower Level Screens. You may also choose to press the escape key to return to the Upper Level Screens.

Zero Meter Screen

If you are already in the Lower Level Screens, push the right or left arrow until you reach the Zero Meter screen. To get this screen at any time: Press Escape—Press Enter—enter password and Press Enter. Then, press the Right or Left arrow until you reach this screen.

From this screen you can change the zero flow bridge differential value to match the zero flow conditions of your application. Mount (or place) the instrument where it is intended to be used, minding orientation, tilt, etc.; The accuracy of this function is dictated on how close to operating conditions the unit is when the meter is zeroed. The display will show:

Zero Meter
Confirm zero flow
Then press enter

Once you push enter, the unit will monitor the sensor bridge differential value. The display will show:

Zero Meter
Confirm zero flow
New Zero

Upon pressing the enter key again, the unit will record the bridge differential value to the zero flow condition, leaving you with a freshly “zeroed” instrument! You can make additional changes by using the left and right arrow keys to move to other Lower Level Screens. You may also choose to press the escape key to return to the Upper Level Screens.

Change Password Screen

If you are already in the Lower Level Screens, push the right or left arrow until you reach the Change Password screen. To get to this screen at any time: Press Escape—Press Enter—enter password and Press Enter. Then, press the Right or Left arrow until you reach this screen.

From this screen you can change the instrument password from the factory default to any four-digit password of your choice. The display will show the factory default password of four zero's: “0000”. The display will show:

Change Password
0000

To make a change, press the enter key. The first digit will begin to blink. Use the up and down arrows to modify this digit or the left and right arrows to choose another digit. When you are satisfied, press enter. The display will show:

Change Password
0000

You can make additional changes by using the left and right arrow keys to move to other Lower Level Screens. You may also choose to press the escape key to return to the Upper Level Screens.



Caution: Once you change the Password, you will not be able to enter the Lower Level without it. Be certain the new password is recorded.

Lost Passwords and General Customer Service

If you lose your password, it will be necessary to contact one of Sierra's Technical Support Centers.

Email Customer Service: service@sierrainstruments.com

FACTORY USA Customer Service:

TOLL FREE: 800-866-0200

PHONE: 831-373-0200

FAX: 831-373-4402

EMAIL: service@sierrainstruments.com

European Customer Service:

PHONE: +31 72 5071400

FAX: +31 72 5071401

EMAIL: service@sierra-instruments.nl

Asia Customer Service:

PHONE: + 8221 5879 8521

FAX: +8621 5879 8586

EMAIL: www.sierra-asia.com

Maintenance Functions

Re-boot the Microprocessor

Should you ever need to reboot the Smart-Trak 2 microprocessor, press the left arrow, the down arrow, the enter key and the escape button simultaneously. The Smart-Trak 2 will re-initialize its microprocessor

CHAPTER 5: Digital Operation RS-232 & Smart-Trak 2 Software

Your Smart-Trak 2 instrument may be operated in three different ways:

THREE CONTROL OPTIONS

- A. Analog Input/Output Operation (Chapter 3):** Using analog input/output signals at the 15-pin mini- D connector.
- B. Digital Operation with Pilot Module (Chapter 4):** Using the optional Pilot Module.
- C. Digital Operation with RS-232 and Smart-Trak 2 Software (This Chapter):** Using the RS-232 Smart-Trak 2 Software package and a PC-style computer running the Windows operating system.

This chapter will discuss “C” above—Digital Operation with your computer via RS-232 and Smart-Trak 2 Software. Although you have chosen to use the RS-232 option, please note that all the Analog control functions are still available on your instrument. Consult Chapter 3 for details on Analog operation. Also, the Pilot Module may be used so long as you make RS-232 communication with the supplied CRN cable. See Chapter 4 for details on operation using the Pilot Module.

If you prefer to write your own software to communicate with the Smart-Trak 2 over the RS-232 link, this is certainly possible. Sierra Instruments will provide the Source Code including the Command Set upon request. Unfortunately, this is the limit of software Technical Support we can extend.

Summary of the Smart-Trak 2 Features

Your Smart-Trak 2 instrument may be easily monitored and adjusted using the supplied Smart-Trak 2 Software package. You should note that the Smart-Trak 2 Software was designed with all the same functions as the Pilot Module. The software allows you to see all changes & parameters at a glance and will allow you to make changes quickly and easily. For review, the features of the Smart-Trak 2 include:

1. Top Level Screens that display information In our software, these screens appear as yellow boxes. They include:

- ❖ Mass flow rate
 - ❖ Gas (10 options pre-programmed, one must be AIR)
 - ❖ Engineering units (mass per unit time)
 - ❖ Current Setpoint with units
 - ❖ Source of Setpoint (analog or digital and type)
 - ❖ Valve operation mode (normal, valve shut or purge)
 - ❖ Current meter full scale value with units (user selectable)
2. Lower level Screens that permit changes to instrument operation In our software, these screens appear as white boxes. They include:
- ❖ Setpoint value
 - ❖ Engineering units
 - ❖ Gas
 - ❖ Valve operation
 - ❖ Source of the setpoint signal
 - ❖ Form of the output signals
 - ❖ Full scale of the instrument
 - ❖ Zero meter
 - ❖ Span meter
3. Additional Features include:
- ❖ Re-boot the Smart-Trak 2 microprocessor
 - ❖ Change the Communication Port
 - ❖ Links to Sierra Instruments' Web Site
 - ❖ Specifications

Power Up Your Instrument



CAUTION: The Smart-Trak 2 is not a loop-powered device. Do not apply power to the 4-20mA outputs.

After your instrument is installed and the system has undergone a complete leak check (discussed in detail in Chapter 2), apply power using Sierra's power supply or your own input power source. See Chapter 2, for power supply requirements. The green LED at the top of the left side will light. If your instrument has a Pilot Module, it will begin its start-up cycle. See Chapter 4 for details on Pilot Module operation.

If you have a Mass Flow Controller, the valve will remain closed until power is supplied. Remember that the valve in the Smart-Trak 2 controller is not a positive shut-off device. When power is applied, the flow control valve will operate per any instructions it receives. When the Smart-Trak 2 is delivered, the valve will be in the

Automatic (Normal) state and the Pilot Module will provide the correct zero setpoint reference for the instrument. As a result, the valve will be closed. However, the valve will return to the state it was in the last time the instrument was operated.



CAUTION: If you do not know the position of the valve before it was shut down, you must assume that the valve will open when power is applied. Take necessary precautions.

Power Up Your Computer

Apply power to your computer per the manufacturer's recommendations. The Smart-Trak 2 Software is compatible with any computer running the following Windows Operating Systems:

Windows 98, 2nd Edition
Windows XP
Windows XP Professional
Windows 2000

Loading the Smart-Trak 2 Software

If you are using your Smart-Trak 2 instrument or your computer for the first time, it is necessary to install the Smart-Trak 2 Software into your computer. If this software is already installed, skip this section. If you want to upgrade the Smart-Trak 2 Software because you have a higher revision, continue below.

Each Smart-Trak 2 order is shipped with a CD-ROM containing the Smart-Trak 2 Software. Locate this disk. At this point, **EXIT OUT OF ANY OPEN APPLICATIONS BEING RUN ON YOUR COMPUTER.**

PROCEDURE:

1. Insert the Smart-Trak 2 Software CD into your CD-ROM
2. Open "My Computer" on your desktop
3. Open the CD Named: "Smart-Trak 2" on your D-drive
4. Run "setup.exe"
5. Follow the instructions on screen



CAUTION: It is recommended that you do not change the default installation directory for this software. The default directory is:

C-drive:\ Program Files.

Changing the installation directory may lead to malfunctions in the software.

Connecting Smart-Trak 2 to Your Computer

If your computer has a serial port...

We suggest you use the supplied Sierra Instruments RS-232 communication cable (part number CRN). This pre-manufactured cable has the correct DB9 connection to mate with most computers and a CAT 5 connector which should be connected to the jack on the side of your new instrument.

With your Smart-Trak 2 **POWERED**, plug CAT 5 connector into the receptacle on the side of your Smart-Trak 2 instrument (See Figure 5-1: Smart-Trak 2 Connections). Next, plug the DB-9 connector to an appropriate serial port on your computer. Note the serial port channel number, especially if there is more than one serial port available. If your computer has only one serial port, it is often named “Comm Port 1.” You will need to know the Comm Port number to communicate with your Smart-Trak 2 instrument.



CAUTION: The CAT-5 connector on the side of the Smart-Trak 2 is NOT an Ethernet connector. Do not plug an Ethernet cable here as damage may result.

All electrical connections for your Smart-Trak 2 instrument are made on the left (inlet) side panel.

Figure 5-1: Smart-Trak 2 Connections

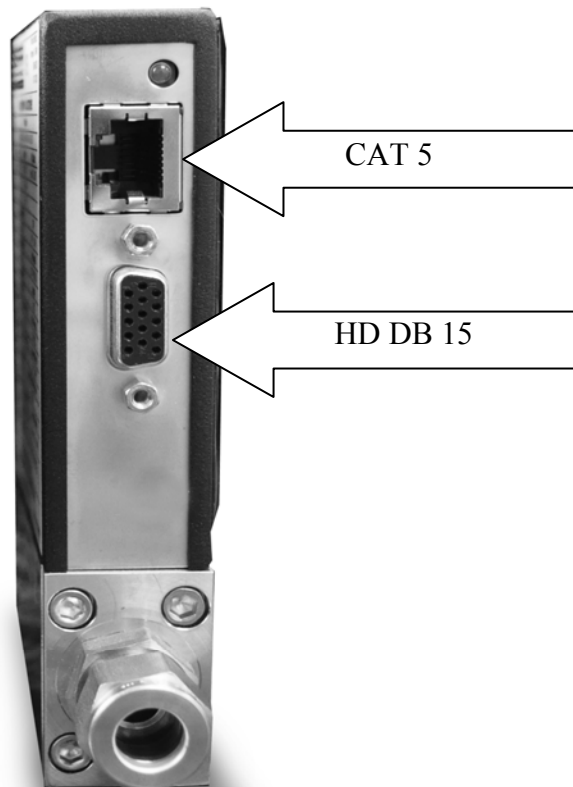

If you do not have the Pilot Module display, you can connect pins 7 (serial transmit), 13 (serial receive) and 3 (analog ground) on the instrument's 15-pin mini-D Connector to an appropriate serial port using a standard DB-9 connector instead of using the supplied CRN cable (see Chapter 2 for wiring instructions). If you use the mini-D connector for your RS-232 communication, please shield the cable to prevent EMI from disrupting communications.

If your computer has no serial port, but has a USB port...

Perform the identical connections as if your computer has a serial port (see previous paragraph), but do not plug the DB-9 connector into your computer. Instead, purchase an appropriate Serial to USB converter. Plug the DB-9 connector into your Serial to USB converter and then plug the USB connector into your computer. Load the necessary software driver into your computer to operate the converter (software and instructions should come with the converter).

Your computer will assign a Comm Port number to your USB adapter, but it will probably not be “Comm Port 1.” Use the Control Panel feature of your computer to identify which Comm Port number has been assigned to your USB adapter.

Open “My Computer” from your desktop.

Next, open “Control Panel.”

Then, open “System.”

Click on the tab labeled “Device Manager.”

Scan down the list until you see the word “Ports,” then right double-click to examine the available Com Ports. Record the number(s). You will need to enter this number or one of these numbers to communicate with your Smart-Trak 2 instrument.

If you plan to control more than one Smart-Trak 2 instrument from your computer...

If your computer has a number of serial ports equal to the number of instruments you wish to operate, simply plug each instrument into a separate serial port as directed above in “If your Computer has a Serial Port...”

If you wish to operate more instruments than your computer has serial ports, you will usually have to use USB ports instead. If the number of USB ports in your computer equals the number of instruments, then purchase one serial to USB converter per Smart-Trak 2 and follow the instructions above. If you have more instruments than ports, you will need to acquire an edge port device (converts one USB port into several serial ports) or a USB hub (converts one USB port into many USB ports). Once you have attached the necessary device and loaded the proper drivers, connect your Smart-Trak 2 instruments to the serial or USB ports as outlined in the sections above. Open a separate software window for each meter and you can monitor all of them at one time.

If connecting your computer to the Smart-Trak 2 creates any confusion, please contact Sierra Instruments or your IT person for assistance.

Running the Smart-Trak 2 Software

Locate the file named “Smart-Trak 2” and open it. You will see the following screen: This is the main data screen. First, you must select the proper comport.

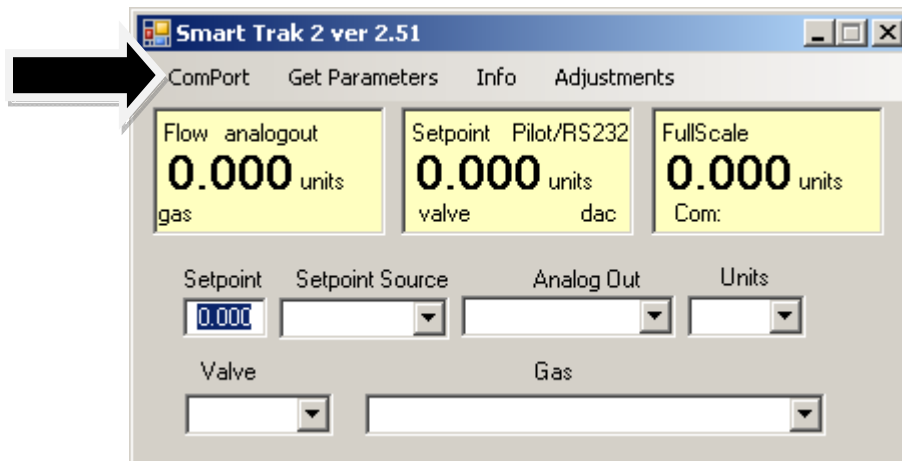

Select the comport pull down menu:

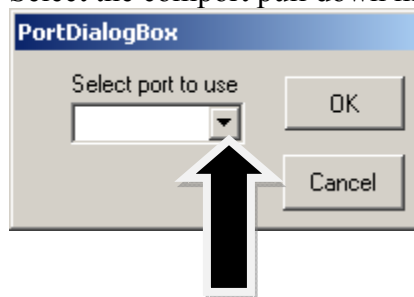

Use the pull-down menu to choose the port number that corresponds to the serial port channel your Smart-Trak 2 is connected to (from 1 to 255). If you have only one serial port, select “Comm Port 1.” When finished, click on the box marked “OK.”

You will be returned to the the Smart-Trak 2 Master Screen. The screen is the same for both meters and controllers. Controller functions will not be active for meters and vice versa

Establishing Communication

If the Screen appears with all the yellow and white boxes full, the Smart-Trak 2 instrument has established communication with your computer.

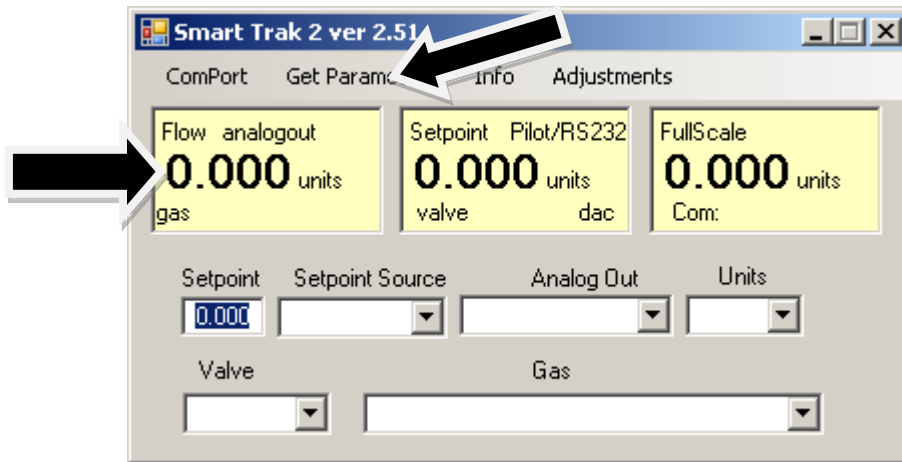

Proceed to the next section.

If the screen appears, but the yellow and white boxes are all empty, you have selected the wrong "Com Port number." See the section titled "Com Port" on page 5-16 for instructions on how to change the communication port number.

If the screen appears, but only the Mass Flow box shows a value, you are using the correct Com Port, but your computer is not talking to the Smart-Trak 2. To begin communication, move the mouse pointer to the top center screen and left click on the words "Get Parameters." then values will fill all the boxes on the screen. Communication has been established. Your computer is now able to control your Smart-Trak 2 instrument.

Your Smart-Trak 2 instrument is now ready for use!

Using the Smart-Trak 2 Software

A. Upper Section of Software Window

Across the upper half of the Smart-Trak 2 Software window you will see 3 yellow boxes. These are titled:

- ❖ Flow
- ❖ Setpoint (flow controllers only. Will show zero for meters)
- ❖ Full Scale

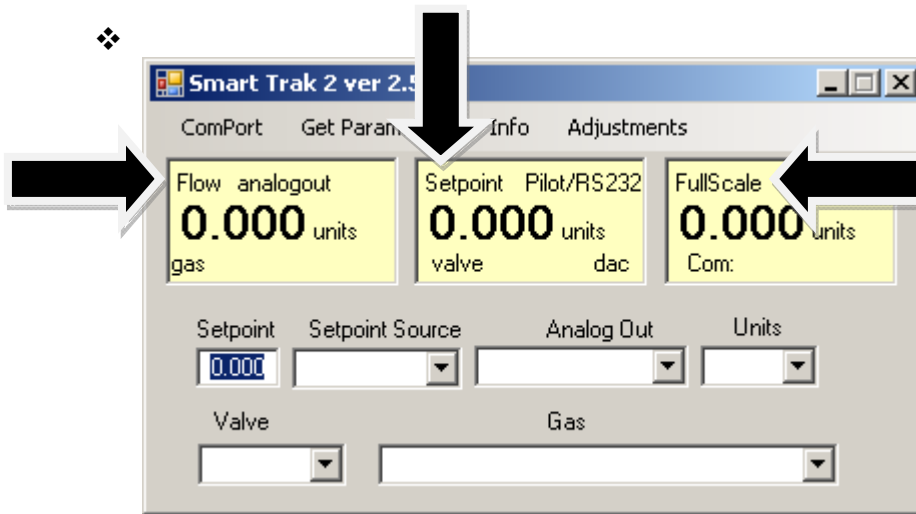

These boxes display the current operating conditions of your Smart-Trak 2 instrument. If you have the Pilot Module, these boxes on the upper half of the software screen are identical to the Upper Level Screens on the Pilot Module discussed in Chapter 4. The features of these boxes are described below.

Flow

The box displays the mass flow rate, the engineering units, the gas choice and the analog output choice.

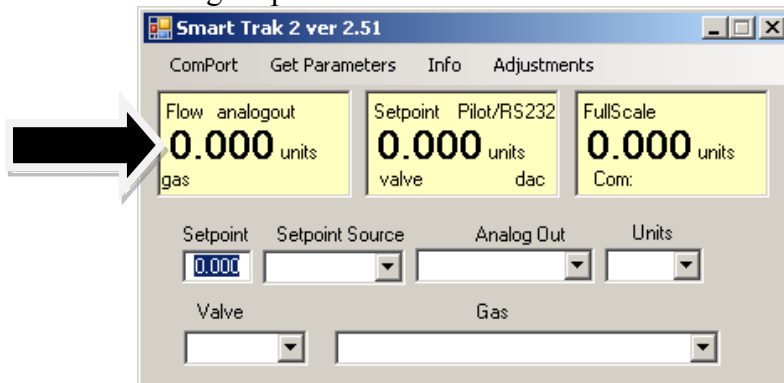

Setpoint

If you have a Mass Flow Meter, this box is zero (as shown above). The Setpoint box displays the current setpoint given to the flow controller, the engineering units, the source of the setpoint signal, the current valve state (open, closed or purge) and the dac values for the valve (for Sierra troubleshooting only).

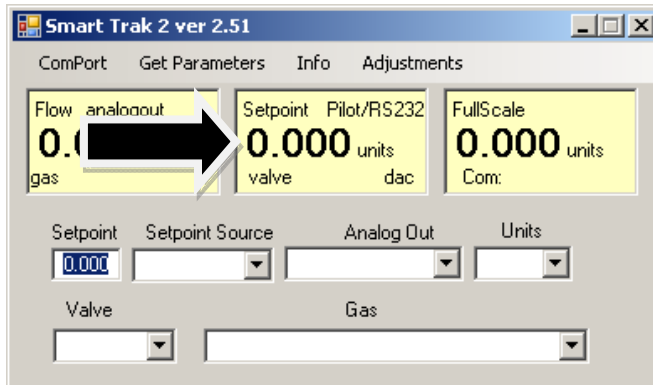

CAUTION: If this box does not show Pilot Module/RS-232 on the first line, you will not be able to give the controller a setpoint command from your computer. This is because you Smart-Trak 2 is expecting an analog setpoint at the 15-pin mini- D-connector. To supply a setpoint from your computer, see “Change Setpoint Source” on page 5-13.

Note on Valve

If you have a Mass Flow Meter, this information can be bypassed. For normal operation of the flow controller, this line should display **Automatic**. If this is visible, the instrument will automatically control flow as soon as a setpoint is given to it.

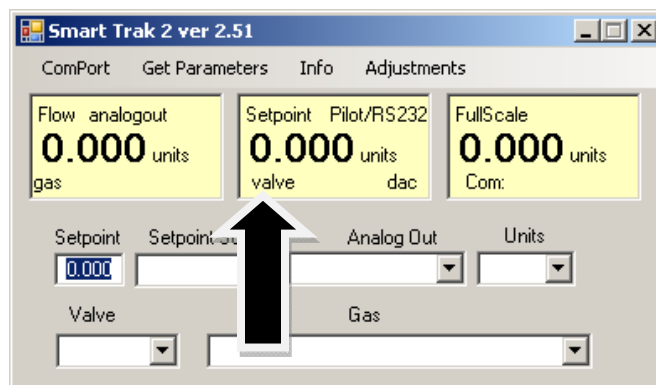

If this box does not display “Automatic,” it will not be possible to control gas flow. Your valve is locked open (Purge) or closed (Closed). See the section titled “Change Valve Operation” below for further instructions

Full Scale

This screen displays the current full-scale value of the instrument with engineering units. It also displays the com port selected and a counter for the com port (for Sierra Troubleshooting only).

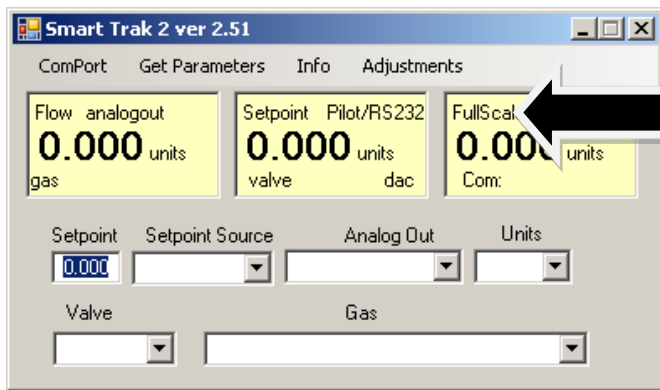

B. Lower Section of Software Window– Changing Parameters

Across the bottom half of the screen you will find a number of white boxes. Each box allows you to adjust one or more meter functions. The various functions are reviewed in the following section.

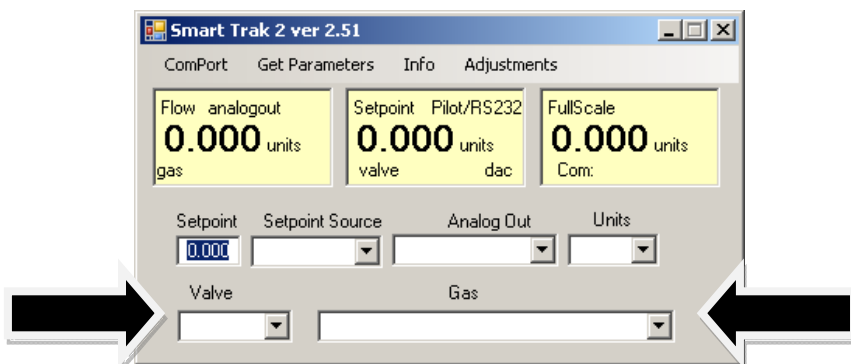

Change Setpoint Value (flow controllers only)

This is the box that allows you to change the setpoint of the mass flow controller. To make a change to the setpoint value, move your pointer to this box and left click. You may change a digit or delete the current setpoint and key in a new one. When you have made your selection, press the enter key to implement it.

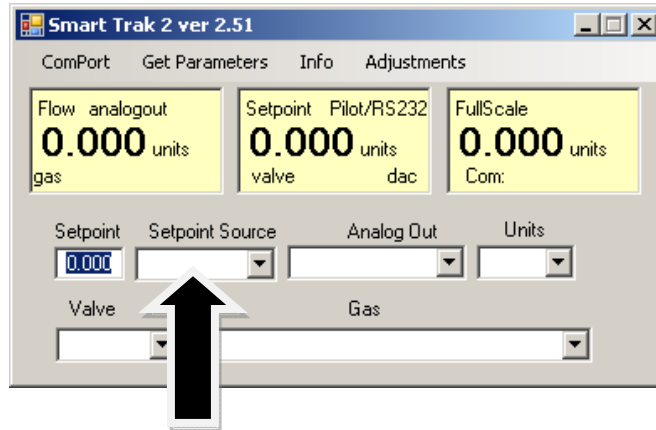

If, instead of using the RS-232 link or the Pilot Module, you prefer to supply analog set point signal to the Smart-Trak 2, activate the pull-down menu. Make your selection carefully and click. Your selection will appear in the box and, after a few seconds, it will also appear in the yellow setpoint box.



CAUTION: If you change the source of the setpoint to one of the analog values, you will not be able to control your Smart-Trak 2 with your computer.

Change Valve Operation –Automatic, Close, Purge

This function enables or overrides any setpoint command given to the Smart-Trak 2. At start-up, the box will show **Automatic**:

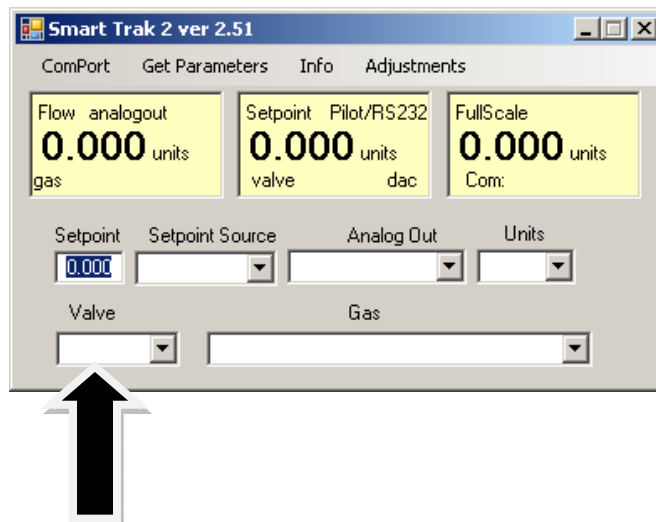

In this normal operating position, the valve is ready to control flow when it receives a setpoint from some source. Using this box, you may set the valve to open well beyond its normal maximum position (“Purge”) or force the valve to remain shut regardless of setpoint (“Closed”). Use the pull down menu to make this change. Choose “purge” to fully open the valve regardless of the given setpoint or choose “closed” to override any setpoint command and close the valve.



CAUTION: Do not activate the valve state pull-down menus unless you are ready to make this change. Once in the pull-down menu, if you click on one of the selections, the valve operation will change immediately. Remember that the Smart-Trak 2 is not a positive shut-off device.



Change Gas (Dial-A-Gas™)

This box will display the current gas selection. If you wish to change the gas used in the instrument, activate the pull-down menu. The 10 gases programmed into the memory of your Smart-Trak 2 will be displayed.

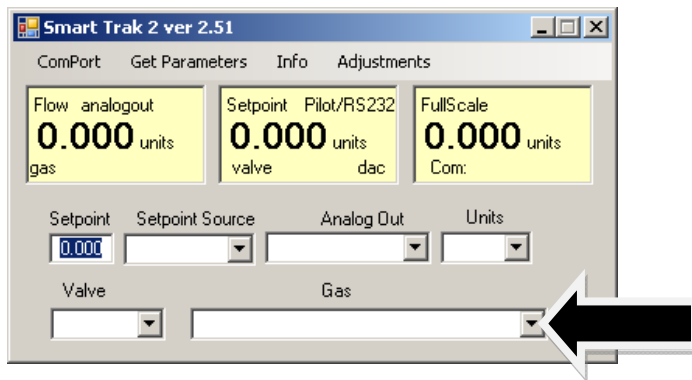

Choose the correct gas for your current application and click. The new gas selection will appear in the box. Within a few seconds, the new gas selection will also appear in the yellow Flow box and the values of the mass flow, setpoint and the full scale will be adjusted for this new gas. This is normal. In some cases, where the thermal properties of one gas are very similar to another, these values may not change very much.

Change Units

This box will show the current engineering units. Should you wish to change the engineering units, use the pull-down menu.

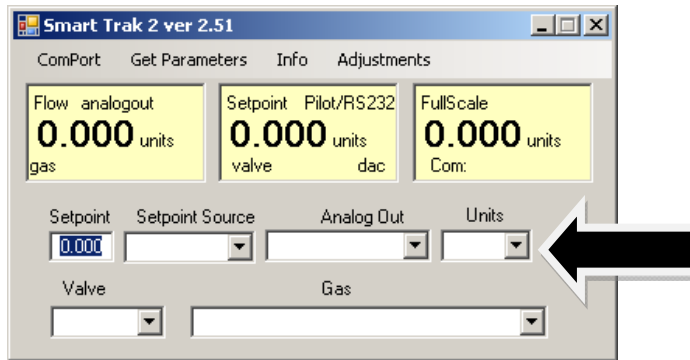

Make your selection, noting that each engineering unit is available with 3 different time constants: seconds, minutes and hours. Choose the combination of units and time constants you desire, then click. The box will display your new selection. Within a few seconds, the units will change in the Flow, Setpoint, and Full Scale boxes and the numerical values will be adjusted into the new units.

Change Analog Out

This box will show the two analog output signals currently selected for your instrument. To re-configure the analog output signals, use the pull-down and make your selection. The Smart-Trak 2 will adjust the analog output voltage signal per your instruction.

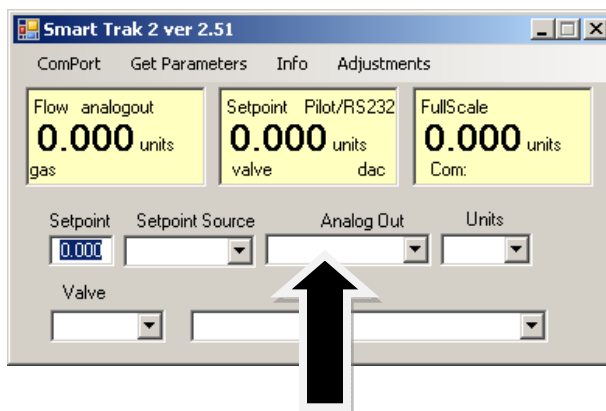

C: ADJUSTMENTS:

Clicking on “adjustments” brings up the meter settings screen.

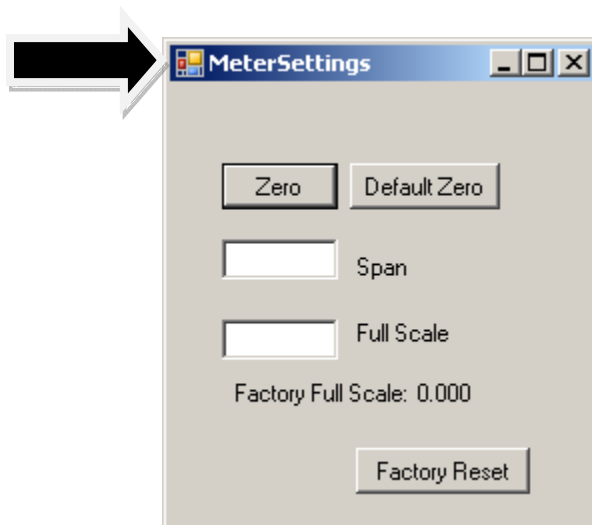
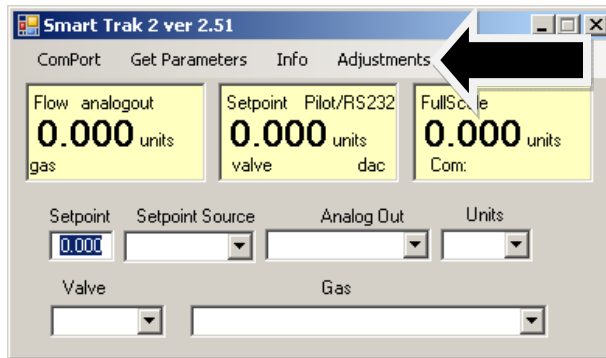

This screen allows for zeroing, spanning and adjusting the full scale for each of the 10 gases in the gas table individually. The screen will be displayed for the gas selected in the gas table on the main screen



Caution: the values in this screen can be set individually for each of the 10 gases. MODIFICATIONS of this screen will only be applicable to the gas displayed. To modify other gases, change the gas in the pull down menu and repeat.

Change Zero:

This button automatically zeros the meter.

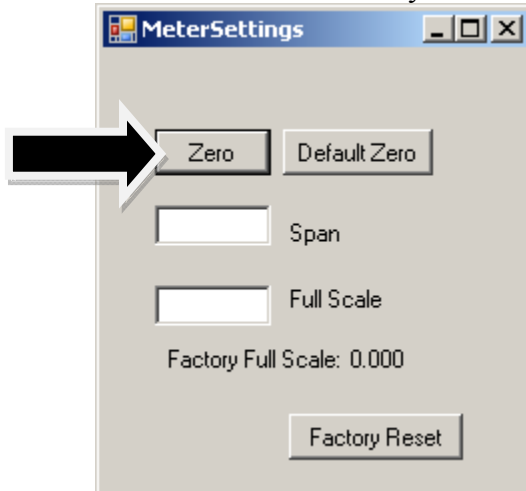

To perform this zero procedure, you must make sure that the actual flow is zero. Attempting to zero the meter or controller while there is a flow condition will cause an offset. Note: This MUST be done using the appropriate gas as selected.



Caution: do not perform auto zero when there is no gas present in the meter and or the gas is FLOWING.

Default zero:

This will set the zero value back to factory conditions. Use this in order to recover from a mistaken entry.

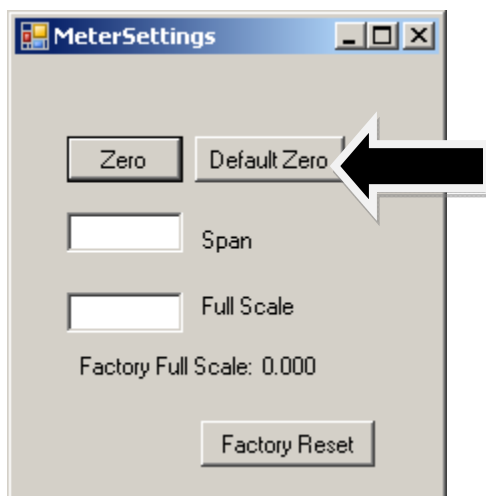

Span:

This allows the user to enter an offset to the span to adjust the meter outputs to match another device or field conditions. The span is a MULTIPLIER and will multiply all outputs by the entered amount.

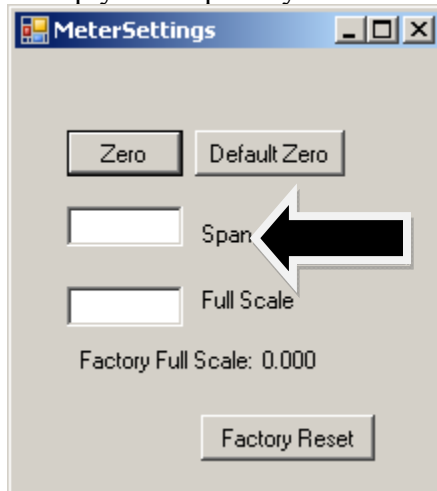

For example, the meter reads 98. The desired reading is 100. A span value of 1.02 will adjust the meter output to read 100.



Caution: this number should not be adjusted beyond 0.8 to 1.2.

Change full scale:

This setting allows you to change the full scale of your instrument

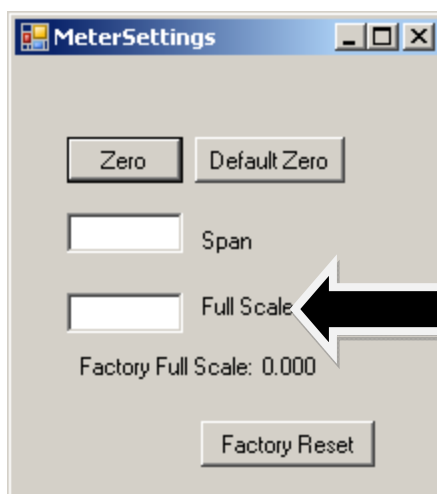

The instrument will display its current full-scale value. If your instrument is new or this value has never been modified, the value displayed will be 100% of the maximum flow rate your Smart-Trak 2 can measure or control without factory recalibration. This is the number listed here:

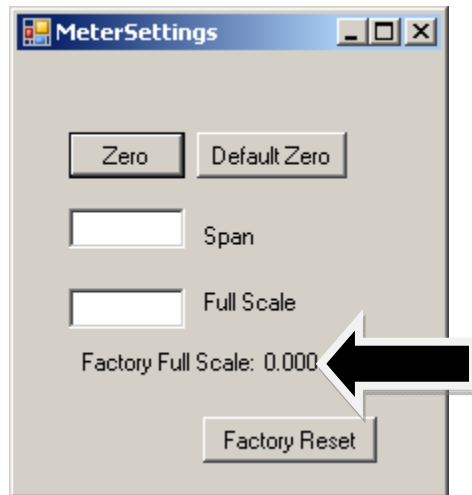

The instrument's maximum flow rate is also recorded on the data label (at the back of the instrument) and on the calibration certificate.

You may select any full-scale value between 100% and 50% of the maximum full-scale value. If you select a new full-scale value, it will re-define the analog outputs of the instrument. The 20 mA signal and the corresponding voltage signal (5 or 10 VDC) will now represent this new full-scale value.

To change the full-scale value of your device, modify one digit or erase the current value displayed and type in your desired full-scale value. When you are satisfied with your selection, press the enter key. The new full-scale value will appear in the white box. A few seconds later, the same value will appear in the yellow box in the upper half of the screen titled "Full Scale."



CAUTION: The Change Full Scale function allows you to re-range your instrument, but it is important to be aware of the limitations of this function. Changing beyond recommended values may require a new LFE or even flow body be installed. If in doubt, select factory reset and both zero and span values are reset to factory values

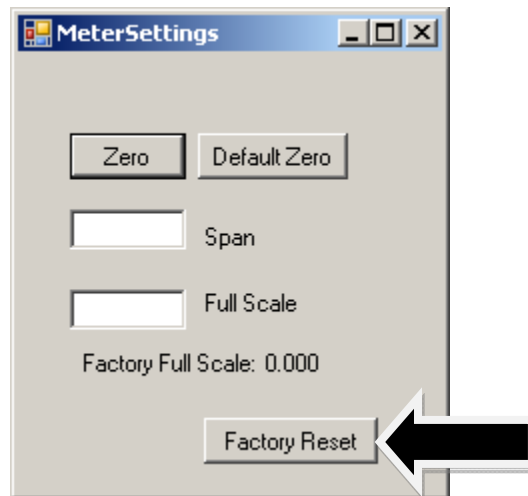

Here are some guidelines to remember if you choose to modify the Full Scale Value: Changing the full-scale value of the instrument does not affect the accuracy of the measurement. Instrument accuracy is a percentage of the original factory full-scale value

If you enter a full-scale value beyond the instrument's calibrated maximum range, the Smart-Trak 2 will automatically modify the full-scale to equal the factory full-scale value. Below 1% of the original factory full-scale value for a meter and 2% for a controller, your Smart-Trak 2 is programmed to read zero because the error in the measurement may exceed the measurement itself.

Other Useful Features

There are several additional features that you may utilize via the Smart-Trak 2 Software. Across the top of the Smart-Trak 2 Master Screen, you can see these options:

- Com Port
- Read Parameters
- Info

To use any of these functions, simply place the mouse pointer onto the name of the feature you wish and left click.

Com Port

To change the communication port for the Smart-Trak 2, click on this feature. Use the pull down menu to choose the Comm Port that your Smart-Trak 2's serial connector is plugged into. Remember that the software asks you to confirm your Comm Port every time you re-start. This feature is designed for situations when you have multiple Comm Ports available and you wish to move the Smart-Trak 2 from one to another or you are controlling more than one Smart-Trak 2 at one time.

Read Controller Parameters

Use this function if you believe your computer and your Smart-Trak 2 instrument may have stopped communicating. It is essentially a re-boot command for the Smart-Trak 2 microprocessor. When you switch Comm Ports, it is recommended that you use this function. If your computer requires a re-boot and you do not unplug your Smart-Trak 2, the communication link will be broken. Use this function to re-establish communication. If at any time, the instrument does not appear to be sending correct information to the Smart-Trak 2 software, try this command to ensure communication.

Info

This gives information about the meter serial and software revisions.

CHAPTER 6: TECHNICAL SUPPORT & SERVICE

Technical Support

If you encounter any problem with your instrument, review the configuration information for each step of the installation, operation, and set up procedures as explained in this manual. Verify that your settings and adjustments are consistent with factory recommendations.

If the problem persists, Sierra is eager to help you. You may contact us at any of the following Technical Support Centers. It may also help to call your Sierra Sales Agent, who is also well trained in the operation of the product.

IMPORTANT: When contacting Technical Support, make sure you have included the following information:

- The flow range, serial number, Sierra order number and model number (all marked on the instrument data label).
- The problem you are encountering and any corrective action taken.
- Application information (gas, pressure, temperature, pipe and fitting configuration).

CUSTOMER SERVICE AND SUPPORT INFORMATION:

Email Technical Support: service@sierrainstruments.com

Email Sales: sales@sierrainstruments.com

FACTORY USA

TOLL FREE: 800-866-0200

PHONE: 831-373-0200

FAX: 831-373-4402

EMAIL: service@sierrainstruments.com

European Sales & Service Center:

PHONE: +31 72 5071400

FAX: +31 72 5071401

EMAIL: service@sierra-instruments.nl

Asia Sales & Service Center:

PHONE: + 8221 5879 8521

FAX: +8621 5879 8586

EMAIL: www.sierra-asia.com

Sierra Websites

Sierra Instruments, Inc. (USA Headquarters): **www.sierrainstruments.com**

Sierra Instruments b.v. (Europe): **www.sierrainstruments.nl**

Sierra Asia Instruments (China): **www.sierra-asia.com**

Returning Equipment to the Factory

Factory Calibration—All Models

Sierra Instruments maintains a fully-equipped calibration laboratory. All measuring and test equipment used in the calibration of Sierra transducers are traceable to NIST Standards. Sierra is ISO-9001 registered and conforms to the requirements of ANSI/NCSSL-Z540 and ISO/IEC Guide 25.

Instructions for Returning Your Instrument for Service

The following information will help you return your instrument to Sierra Instruments' Factory Service Center and will ensure that your order is processed promptly. Prices may vary depending on the flow range, type of gas and operating pressure of your unit. To request detailed pricing contact your local Sierra Instruments distributor or contact one of our offices directly. Our expedite fees are: three-day turnaround 25%, two-day turnaround 40%.

Please follow these easy steps to return your instrument for factory service:

1. Obtain a Return Materials Authorization (RMA) number from Sierra Instruments. You may obtain this from the factory by calling (800) 866 0200 between 8:00 a.m. and 5:00 p.m. PST Monday through Friday. You may also obtain this number via e-mail by contacting service@sierrainstruments.com.
2. Once you have obtained an RMA number, complete the RMA form. If you require service beyond calibration, but do not know which service(s) will be required, describe the symptoms as accurately as possible on the RMA form. Submit electronically or by fax to (831) 373-2414.
3. Pack your instrument carefully. Use the original packaging and foam or bubble wrap (packing peanuts NOT recommended) and include a copy of the RMA form (complete with Sierra supplied RMA number) with the unit(s). This is particularly important when shipping the medium and high flow versions. Due to their weight, they can be damaged in transit if not packed properly.

4. Ship the unit(s) to the following address:

RETURN ADDRESS:

**Sierra Instruments, Inc.
Attention: Factory Service Center
5 Harris Court, Building L
Monterey, CA 93940 USA**

IMPORTANT SAFETY NOTE ABOUT PURGING



WARNING: When toxic or corrosive gases are used, purge unit thoroughly with inert dry gas before disconnecting from the gas line to prevent personnel from being injured when coming in contact with the instrument.



WARNING: If an instrument used with a toxic or corrosive gas is returned to the factory, a Material Safety Data Sheet (MSDS) must be enclosed & attached to the outside of the box to alert Sierra personnel of the potential hazard. Also, make sure the inlet & outlet are solidly plugged off.

Appendix A: Gas Tables

Smart-Trak 2 Pre-programmed Gases: Dial-A-Gas

The following gases have been programmed into the Smart-Trak 2 instrument in this order. If you are using one of these gases, you may use the Dial-A-Gas feature in either the Pilot Module or the Software Package and the instrument will adjust the outputs automatically.

1. Air
2. Argon
3. CO₂
4. CO
5. Helium
6. Hydrogen
7. Methane
8. Nitrogen
9. Nitrous Oxide
10. Oxygen



K-Factor Calculations-- Using Smart-Trak 2 with Other Gases

If you will be using Smart-Trak 2 with a gas not on this list, you may use the tables below. They provide K-factors and thermodynamic properties of gases commonly used with mass flow meters and controllers. This is particularly useful if the actual gas is not a common gas or if it is toxic, flammable, corrosive, etc. The tables can also be used to interpret the reading of a flow meter or flow controller that has been calibrated with a gas other than the actual gas.

Before applying the tables, set the instrument for Air. Then, the following fundamental relationship may be used:

$$Q_1/Q_N = K_1/K_N$$

Where:

Q = The volumetric flow rate of the gas referenced to standard conditions of 0°C and 760 mm Hg (sccm or slm),

K = The K-factor from the following tables, referenced to Air

()₁ = Refers to the “actual” gas, and

()_N = Refers to the “reference” gas, Air in this case.

Gas Tables and K-factors

Actual Gas	Chemical Symbol	K-factor Relative to Air	Cp (Cal/g)	Density (g/l) @ 70°F	Density (g/l) @ 0°C	Elastomers*	
						O-ring	Valve Seat
Acetylene	C ₂ H ₂	.581	.4036	1.079	1.162		
Air		1.000	.240	1.200	1.293		
Allene (Propadiene)	C ₃ H ₄	.431	.352	1.659	1.787		KR
Ammonia	NH ₃	.732	.492	.706	.760	NEO	KR/NEO
Argon	Ar	1.398	.1244	1.655	1.782		
Arsine	AsH ₃	.671	.1167	3.229	3.478		KR
Boron Trichloride	BCl ₃	.411	.1279	4.852	5.227	800 Series Recommended	
Boron Trifluoride	BF ₃	.511	.1778	2.808	3.025		KR
Boron Tribromide	Br ₃	.381	.0647	10.378	11.18		KR
Bromine	Br ₂	.812	.0539	6.619	7.130		
Bromine Pentafluoride	BrF ₅	.261	.1369	7.244	7.803		KR
Bromine Trifluoride	BrF ₃	.381	.1161	5.670	6.108		KR
Bromotrifluoromethane (Freon-13 B1)	CBrF ₃	.371	.1113	6.168	6.644		
1,3-Butadiene	C ₄ H ₆	.321	.3514	2.240	2.413		
Butane	C ₄ H ₁₀	.261	.4007	2.407	2.593	NEO	KR
1-Butane	C ₄ H ₈	.301	.3648	2.324	2.503	NEO	KR
2-Butane	C ₄ H ₈ CIS	.325	.336	2.324	2.503	NEO	KR
2-Butane	C ₄ H ₈ TRANS	.292	.374	2.324	2.503		
Carbon Dioxide	CO ₂	.737	.2016	1.835	1.964		
Carbon Disulfide	CS ₂	.601	.1428	3.153	3.397		
Carbon Monoxide	CO	1.002	.2488	1.160	1.250		
Carbon Tetrachloride	CCl ₄	.311	.1655	6.368	6.860		KR
Carbon Tetrafluoride (Freon-14)	CF ₄	.421	.1654	3.645	3.926		KR
Carbonyl Fluoride	COF ₂	.541	.1710	2.734	2.945		
Carbonyl Sulfide	COS	.661	.1651	2.488	2.680		
Chlorine	Cl ₂	.862	.114	2.936	3.163	800 Series Recommended	
Chlorine Trifluoride	ClF ₃	.401	.1650	3.829	4.125		KR
Chlorodifluoromethane (Freon-22)	CHClF ₂	.461	.1544	3.581	3.858		KR
Chloroform	CHCl ₃	.391	.1309	4.944	5.326		KR
Chloropentafluoroethane (Freon-115)	C ₂ ClF ₅	.241	.164	6.398	6.892		KR
Chlorotrifluoromethane (Freon-13)	CClF ₃	.381	.153	4.326	4.660		KR
Cyanogen	C ₂ N ₂	.611	.2613	2.156	2.322		KR
Cyanogen Chloride	ClCN	.611	.1739	2.545	2.742		
Cyclopropane	C ₃ H ₅	.461	.3177	1.742	1.877		KR
Deuterium	D ₂	1.002	.1722	1.670	1.799		
Diborane	B ₂ H ₆	.441	.508	1.147	1.235		KR
Dibromodifluoromethane	CBr ₂ F ₂	.190	.15	8.691	9.362		KR
Dibromomethane		.471	.075	7.204	7.76		KR
Dichlorodifluoromethane (Freon-12)	CCl ₂ F ₂	.351	.1432	5.008	5.395		KR
Dichlorofluoromethane (Freon-21)	CHCl ₂ F	.421	.140	4.597	4.952		KR

- If no O-ring material is specified then O-ring to be used is Viton. NEO is neoprene or equivalent. KR is DuPont Kalrez or equivalent. Valve Seat applies only to controllers.

Actual Gas	Chemical Symbol	K-factor Relative Air	Cp (Cal/g)	Density (g/l) @ 70°F	Density (g/l) @ 0°C	Elastomers* O-ring	Valve Seat
Dichloromethylsilane	(CH ₃) ₂ SiCl ₂	.251	.1882	5.345	5.758		KR
Dichlorosilane	SiH ₂ Cl ₂	.401	.150	4.183	4.506		KR
Dichlorotetrafluoroethane (Freon-114)	C ₂ Cl ₂ F ₄	.220	.1604	7.079	7.626		KR
1,1-Difluoroethylene (Freon-1132A)	C ₂ H ₂ F ₂	.185	.224	2.652	2.857		KR
Dimethylamine	(CH ₃) ₂ NH	.371	.366	1.867	2.011		KR
Dimethyl Ether	(CH ₃) ₂ O	.391	.3414	1.908	2.055		KR
2,2-Dimethylpropane	C ₃ H ₁₂	.220	.3914	2.988	3.219		KR
Ethane	C ₂ H ₆	.501	.4097	1.246	1.342		
Ethanol	C ₂ H ₆ O	.391	.3395	1.908	2.055		KR
EthylAcetylene	C ₄ H ₆	.321	.3513	2.240	2.413		KR
Ethyl Chloride	C ₂ H ₅ Cl	.391	.244	2.673	2.879		KR
Ethylene	C ₂ H ₄	.601	~.358	1.161	1.251		
Ethylene Oxide	C ₂ H ₄ O	.521	.268	1.824	1.965		KR
Fluorine	F ₂	.982	.1873	1.574	1.695	800 Series Recommended	
Fluoroform (Freon-23)	CHF ₃	.501	.176	2.903	3.127		KR
Freon-11	CCl ₃ F	.331	.1357	5.690	6.129		KR
Freon-12	CCl ₂ F ₂	.351	.1432	5.008	5.395		KR
Freon-13	CCIF ₃	.381	.153	4.326	4.660		KR
Freon-13	B1 CFrF ₃	.371	.1113	6.168	6.644		KR
Freon-14	CF ₄	.421	.1654	3.645	3.926		
Freon-21	CHCl ₂ F	.421	.140	4.597	4.952		KR
Freon-22	CHClF ₂	.461	.1544	3.581	3.858		KR
Freon-113	CCl ₂ FCCIF ₂	.200	.161	7.761	8.360		KR
Freon-114	C ₂ Cl ₂ F ₄	.220	.160	7.079	7.626		KR
Freon-115	C ₂ ClF ₅	.241	.164	6.398	6.892		KR
Freon-C318	C ₄ F ₆	.170	.185	7.795	8.397		KR
Germane	GeH ₄	.571	.1404	3.173	3.418		
Germanium Tetrachloride	GeCL ₄	.271	.1071	8.879	9.565		KR
Helium	He	1.399	1.241	.164	.1786		
Hexafluoroethane (Freon-116)	C ₂ F ₆	.241	.1834	5.716	6.157		KR
Hexane	C ₆ H ₁₄	.180	.3968	3.569	3.845		KR
Hydrogen	H ₂	1.001	3.419	.083	.0899		
Hydrogen Bromide	HBr	1.002	.0861	3.351	3.610		KR
Hydrogen Chloride	HCl	1.002	.1912	1.510	1.627	800 Series Recommended	
Hydrogen Cyanide	HCN	1.072	.3171	1.120	1.206		KR
Hydrogen Fluoride	HF	1.002	.3479	.829	.893	800 Series Recommended	
Hydrogen Iodide	HI	1.002	.0545	5.298	5.707		KR
Hydrogen Selenide	H ₂ Se	.792	.1025	3.354	3.613		KR
Hydrogen Sulfide	H ₂ S	.802	.2397	1.411	1.520	NEO	KR
Iodine Pentafluoride	IF ₅	.251	.1108	9.190	9.90		KR
Isobutane	CH(CH ₃) ₃	.271	.3872	3.335	2.593		KR
Isobutylene	C ₄ H ₈	.291	.3701	2.324	2.503		KR
Krypton	Kr	1.456	.0593	3.471	3.739		
Methane	CH ₄	.754	.5328	.665	.715		
Methanol	CH ₃ OH	.581	.3274	1.327	1.429		
Methyl Acetylene	C ₃ H ₄	.431	.3547	1.659	1.787		KR
Methyl Bromide	CH ₃ Br	.581	.1106	3.932	4.236		
Methyl Chloride	CH ₃ Cl	.193	2.253	2.092			KR
Methyl Fluoride	CH ₃ F	.681	.3221	1.409	1.518		KR

- If no O-ring material is specified then O-ring to be used is Viton. NEO is neoprene or equivalent. KR is DuPont Kalrez or equivalent. Valve Seat applies only to controllers.

Actual Gas	Chemical Symbol	K-factor Relative Air	Cp (Cal/g)	Density (g/l) @ 70°F	Density (g/l) @ 0°C	Elastomers* O-ring	Valve Seat
Methyl Mercaptan	CH ₃ SH	.521	.2459	1.992	2.146		KR
Methyl Trichlorosilane	(CH ₃) ₃ SiCl ₃	.251	.164	6.191	6.669		KR
Molybdenum Hexafluoride	MoF ₆	.210	.1373	8.695	9.366		KR
Monoethylamine	C ₂ H ₅ NH ₂	.351	.387	1.867	2.011		KR
Monomethylamine	CH ₃ NH ₂	.511	.4343	1.287	1.386		KR
Neon	NE	1.463	.245	.836	.900		
Nitric Oxide	NO	.992	.2328	1.243	1.339		
Nitrogen	N ₂	1.002	.2485	1.161	1.25		
Nitrogen Dioxide	NO ₂	.742	.1933	1.905	2.052	800 Series Recommended	
Nitrogen Trifluoride	NF ₃	.481	.1797	2.941	3.168		KR
Nitrosyl Chloride	NOCl	.611	.1632	2.711	2.920		KR
Nitrous Oxide	N ₂ O	.716	.2088	1.836	1.964		
Octafluorocyclobutane (Freon-C318)	C ₄ F ₆	.170	.185	7.795	8.397		KR
Oxygen Difluoride	OF ₂	.631	.1917	2.234	2.406		
Oxygen	O ₂	.998	.2193	1.326	1.427		
Ozone	O ₃	.447	.3	1.990	2.144		
Pentaborane	B ₅ H ₉	.261	.38	2.614	2.816		KR
Pentane	C ₅ H ₁₂	.210	.398	2.988	3.219		KR
Perchloryl Fluoride	ClO ₃ F	.391	.1514	4.243	4.571		KR
Perfluoropropane	C ₃ F ₈	.174	.197	7.787	8.388		KR
Phosgene	COCl ₂	.441	.1394	4.101	4.418		KR
Phosphine	PH ₃	.762	.2374	1.408	1.517		KR
Phosphorous Oxychloride	POCl ₃	.361	.1324	6.352	6.843		KR
Phosphorous Pentafluoride	PF ₅	.301	.1610	5.217	5.620		KR
Phosphorous Trichloride	PCl ₃	.301	.1250	5.688	6.127		KR
Propane	C ₃ H ₈	.335	.3885	1.826	1.967		
Propylene	C ₃ H ₆	.411	.3541	1.742	1.877		
Silane	SiH ₄	.601	.3189	1.330	1.433		KR
Silicon Tetrachloride	SiCl ₄	.281	.1270	7.037	7.580		KR
Silicon Tetrafluoride	SiF ₄	.351	.1691	4.310	4.643		KR
Sulfur Hexafluoride	SF ₆	.261	.1592	6.049	6.516		KR
Sulfuryl Fluoride	SO ₂ F ₂	.391	.1543	4.235	4.562		KR
Teos		.090				800 Series Recommended	
Tetrafluorohydrazine	N ₂ F ₄	.321	.182	4.307	4.64		KR
Trichlorofluoromethane (Freon-11)	CCl ₃ F	.331	.1357	5.690	6.129		KR
Trichlorosilane	SiHCl ₃	.331	.1380	5.610	6.043		KR
1,1,2-Trichloro-1,2,2-Trifluoroethane (Freon-113)	CCl ₂ FCFClF ₂	.200	.161	7.761	8.360		KR
Trisobutyl Aluminum	(C ₄ H ₉) ₃ Al	.061	.508	8.214	8.848		KR
Titanium Tetrachloride	TiCl ₄	.271	.120	7.858	8.465		KR
Trichloro Ethylene	C ₂ HCl ₃	.321	.163	5.523	5.95		KR
Trimethylamine	(CH ₃) ₃ N	.281	.3710	2.450	2.639		KR
Tungsten Hexafluoride	WF ₆	.251	.0810	12.328	13.28	800 Series Recommended	
Uranium Hexafluoride	UF ₆	.200	.0888	14.574	15.70		KR
Vinyl Bromide	CH ₂ CHBr	.461	.1241	4.430	4.772		KR
Vinyl Chloride	CH ₂ CHCl	.481	.12054	2.588	2.788		KR
Xenon	Xe	1.443	.0378	5.438	5.858		

- If no O-ring material is specified then O-ring to be used is Viton. NEO is neoprene or equivalent. KR is DuPont Kalrez or equivalent. Valve Seat applies only to controllers.

Appendix B: Product Specifications

Performance Specifications:

Accuracy

Standard Calibration: $\pm 1.0\%$ of full scale at operating conditions

High Accuracy Calibration: $\pm 0.7\%$ of reading plus 0.3% of full scale at operating conditions.

Dial-A-Gas: $\pm 1.0\%$ of full scale in all 10 gases

Repeatability

$\pm 0.2\%$ of full scale

Temperature Coefficient

$\pm 0.025\%$ of full scale per °F ($\pm 0.05\%$ of full scale per °C), or better

Pressure Coefficient

$\pm 0.01\%$ of full scale per psi (± 0.15 of full scale per bar), or better

Response Time

300 millisecond time constant--2 seconds (typical) to within $\pm 2\%$ of final value (includes settling time)

Operating Specifications:

Gases

All clean gases including corrosives; specify when ordering. The following 10 gases make up the standard Dial-A-Gas feature. Alternate gases may be substituted at time of ordering. Flow rates in slpm.

GAS	Maximum Flow Low Flow Body	Maximum Flow Medium Flow Body	Max Flow Rate High Flow Body
Air	50	300	1000
Argon	72.5	435	1450
Carbon Dioxide (CO ₂)	37	220	740
Carbon Monoxide (CO)	50	302	1000
Methane (CH ₄)	36	227	720
Helium	72.7	420	1454
Hydrogen	50	300	1000
Oxygen	50	300	1000
Nitrogen	50	300	1000
Nitrous Oxide (N ₂ O)	35.5	215	710

Mass Flow Rates

101 Micro-Trak: 0 to 4 sccm

100L low flow body: 0 to 10 sccm to 0 to 50slpm

100M medium flow body: 0-20 to 0-300 slpm

100H high flow body: 0-100 to 0-1000 slpm

Flow ranges specified are for nitrogen at 760 mm Hg and 21°C (70°F) or for an equivalent;
other engineering units are available (e.g., nlpm, scfh, nm³/h or kg/h)

Gas Pressure

500 psig (34 barg) maximum, burst tested to 750 psig (52 barg).

Pressure Drop across a Meter

Pressure must be above the values in the table below. Note that pressure increases with flow rate.

Minimum Pressure Drop for Air, Mass Flow Meters					
Flow Rate (slpm)	Pressure Drop in PSI (mbar)				
	Low Flow ¼ inch fittings (std)	Low Flow 3/8 inch fittings (opt.)	Medium Flow 3/8 or ½ inch fittings	High Flow Small Bore (100H) (std up to 500 slpm) ½ comp fittings	High Flow Large Bore (H1, H2) (std 501-1000 slpm) ¾ comp fittings
0.1	0.36 (24.5)	N/A	N/A	N/A	N/A
0.5	0.36 (24.5)	N/A	N/A	N/A	N/A
1	0.37 (25.4)	N/A	N/A	N/A	N/A
10	0.46 (31.7)	0.41 (28.6)	N/A	N/A	N/A
20	0.66 (45.7)	0.47 (32.7)	0.5 (34)	N/A	N/A
30	N/A*	0.59 (40.9)	0.5 (34)	N/A	N/A
40	N/A*	0.77 (53.3)	0.5 (34)	N/A	N/A
50	N/A*	1.00 (68)	0.5 (34)	N/A	N/A
100	N/A	N/A	1.0 (68)	1.0 (68)	0.5 (34)
150	N/A	N/A	2.0 (136)	1.2 (81.6)	0.5 (34)
200	N/A	N/A	3.0 (204)	1.5 (102)	0.5 (34)
250	N/A	N/A	4.0 (272)	1.8 (122.4)	0.5 (34)
300	N/A	N/A	5.5 (374)	2 (136)	0.6 (408)
350	N/A	N/A	7.5 (510)	2.5 (170)	0.7 (476)
400	N/A	N/A	10 (680)	3 (204)	0.9 (612)
450	N/A	N/A	N/A	3.5 (238)	1.1 (748)
500	N/A	N/A	N/A	4 (272)	1.3 (884)
750	N/A	N/A	N/A	N/A*	3.0 (204)
1000	N/A	N/A	N/A	N/A*	5.0 (340)

Note: tests performed at 21 degrees C, outlet at ambient pressure

*Larger fittings recommended for these flow rates because these fittings reduce overall performance.

Differential Pressure Requirement for Controllers

(lower or higher available upon request)

Optimum: 30-60 psi (2-4 bar)

Minimum: See chart below. Note that required pressure increases with flow rate.

Minimum Differential Pressure Requirement for Air, Mass Flow Controllers					
Flow Rate (slpm)	Pressure Drop in PSI (mbar)				
	Low Flow ¼ inch fittings (std)	Low Flow 3/8 inch fittings (opt.)	Medium Flow 3/8 or ½ inch fittings	High Flow Small Bore (100H) (std up to 500 slpm) ½ comp fittings	High Flow Large Bore (H1, H2) (std 501-1000 slpm) ¾ comp fittings
0.1	1 (68)	1 (68)	N/A	N/A	N/A
1	1.5 (102)	1.28 (87)	N/A	N/A	N/A
10	6 (408)	3.8 (258)	N/A	N/A	N/A
20	12 (816)	6.6 (449)	1 (68)	N/A	N/A
30	15 (1020) *	9.4 (639)	1.2 (82)	N/A	N/A
40	30 (2040) *	12.2 (830)	1.6 (110)	N/A	N/A
50	40 (2720) *	15 (1020)	2 (136)	N/A	N/A
100	N/A	N/A	5 (340)	1.5 (102)	1.0 (68)
150	N/A	N/A	10 (680)	2 (136)	1.0 (68)
200	N/A	N/A	15 (1020)	4.5 (306)	1.0 (68)
250	N/A	N/A	20 (1360)	5.5 (374)	1.5 (102)
300	N/A	N/A	25 (1700)	6.5 (442)	2.0 (136)
350	N/A	N/A	30 (2040)	8.5 (578)	3.0 (204)
400	N/A	N/A	35 (2380)	10.5 (714)	4.0 (272)
450	N/A	N/A	N/A	13 (884)	5.0 (340)
500	N/A	N/A	N/A	15 (1020)	6.0 (408)
750	N/A	N/A	N/A	N/A*	15 (1020)
1000	N/A	N/A	N/A	N/A*	20 (1360)

Note: tests performed at 21 degrees C, outlet at ambient pressure

*Larger fittings recommended for these flow rates because these fittings reduce overall performance

Gas & Ambient Temperature

32 to 122°F (0 to 50°C)

Leak Integrity

5 X 10⁻⁹ standard cc/sec of helium maximum

Power Requirements

Ripple should never exceed 100 mV peak-to-peak

For Mass Flow Meters: 15-24 ±10%, VDC, (230mA, regulated)

For Mass Flow Controllers: C100L: 24 VDC ±10%, (500mA, regulated)

C100M: 24 VDC ±10%, (800mA, regulated)

C100H: 24 VDC ±10%, (1260mA, regulated)

Control Range

2–100% of full scale flow; automatic shut-off at 1.9%.

Output Signals--Analog:

Linear 4–20 mA, 500 ohms maximum loop resistance plus one of the following (user selectable):

Linear 0–5 VDC, 1000 ohms minimum load resistance

Linear 0-10 VDC, 1000 ohms minimum load resistance

Linear 1-5 VDC, 1000 ohms minimum load resistance

Output Signals--Digital:

RS-232 (standard)

Pilot module (optional)

Command Signal--Analog (choice of one):

Linear 4–20 mA

Linear 0–5 VDC

Linear 0-10 VDC

Linear 1-5 VDC

Command Signal--Digital:

RS-232

Pilot module (optional)

Physical Specifications:**Wetted Materials**

316 stainless steel or equivalent, 416 stainless steel, Viton® “O”-rings and valve seat (standard). Other elastomers are available upon request.

Optional Parts & Accessories:

The following optional accessories are available from your Authorized Sierra Instruments Representative or directly from Sierra Instruments. They are provided to improve your experience with the Smart-Trak 2 Series 100 Mass Flow Meters and Controllers. Call or write for current pricing and availability.

Description	Order Code
Remote Pilot Module	RDO
Compod without display	CM-NR
Compod with display	CM-DD
Compod with Relays	CM-Relays
Power Supply with D-connector attached, USA plug	100 T8D
Power Supply with fly leads (bare wires), USA plug	100 T8F
Power Supply with D-connector for C100H units	100 T10D
Power Supply with fly leads (bare wires) for C100H units	100 T10F
Multi-adapter with voltage regulator (to permit operation with less than 24 Vdc)	100 Conv
15 pin mini-D mating connector only	C0
Communication cable—6 inch	C1
Communication cable—3 foot	C3
Communication cable—10 foot	C10
Communication cable—Custom length	C () specify length
RS-232 cable, 10 foot, with CAT 5 on one end and Standard DB-9 connector on the other	CRN
10 micron filter for M100L or C100L	100L Filter
10 micron filter for M100M or C100M	100M Filter
10 micron filter for M100H or C100H	100H Filter

Ordering Parts & Accessories:

Email Customer Service: service@sierrainstruments.com

FACTORY USA:

TOLL FREE: 800-866-0200
 PHONE: 831-373-0200
 FAX: 831-373-4402
 EMAIL: service@sierrainstruments.com

European Sales & Service Center:

PHONE: +31 72 5071400
 FAX: +31 72 5071401
 EMAIL: service@sierra-instruments.nl

Asia Sales & Service Center:

PHONE: + 8221 5879 8521
 FAX: +8621 5879 8586
 EMAIL: www.sierra-asia.com

Appendix C: Flow Chart for Pilot Module User Interface

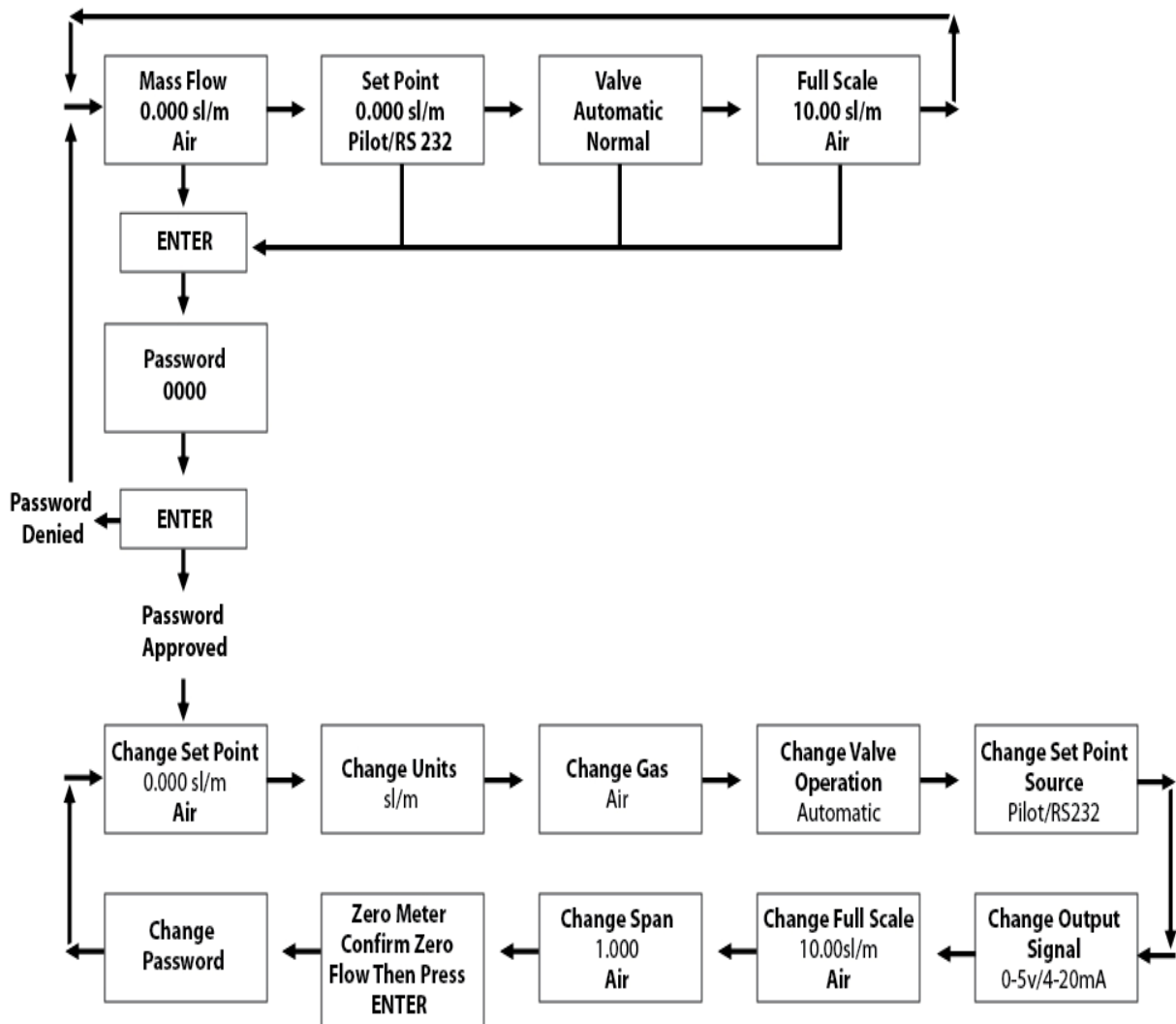

Note: If you press the escape key at any time, you will immediately return to the main Mass Flow screen in the Upper Level.

Appendix D: PIN Configuration

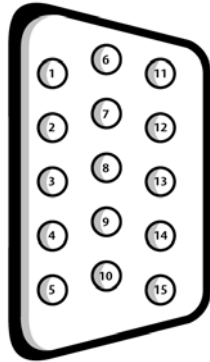

Figure 2-4: Wiring Definitions for Optional Communication Cable

Pin #	Wire Color in Cable	Function
1.	Brown	Analog Ground/Output
2.	Red	0-5 VDC Output (or 0-10, 1-5 VDC)
3.	Orange	Analog Ground/RS232
4.	Pink	Valve Override Purge
5.	Yellow	Power Return (-)
6.	Green	Power Input (+)
7.	Green/White	RS-232 Transmit (out)
8.	Blue	Setpoint
9.	Purple	Not Used
10.	Gray	Analog Ground/Setpoint
11.	White	Reference Voltage (5 VDC External Setpoint & Valve Purge)
12.	Black	Valve Override Close
13.	Brown/white	RS-232 Receive (in)
14.	Red/white	4-20 mA Output
15.	Red/Black	Not Used
	Shield Wire (no insulation)	Chassis (Earth) Ground

Note: Pins 1, 3, and 10 are connected together inside the instrument. Do not tie these grounds together outside the instrument. Must have one connection per analog ground. Recommended use listed.

Appendix E: Product Dimensions and Mounting

All dimensions are in inches with millimeters in (brackets). Dimension "L" is listed in the Table at the end of Appendix E.

M100L & C100L Front View

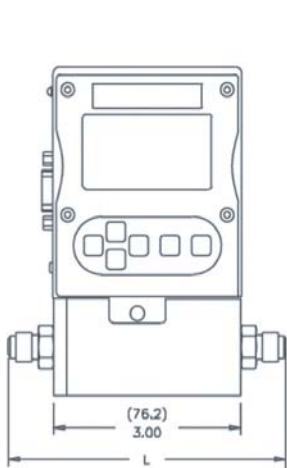

M100L & C100L Inlet View

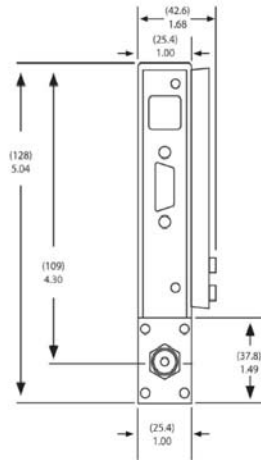

M100M Front View

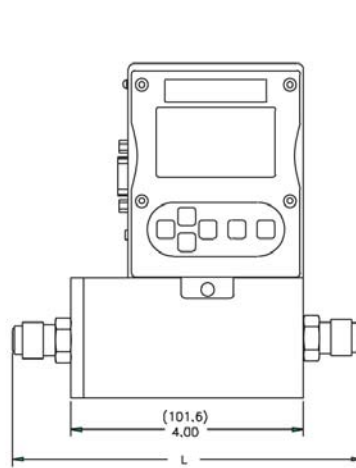

M100M Inlet View

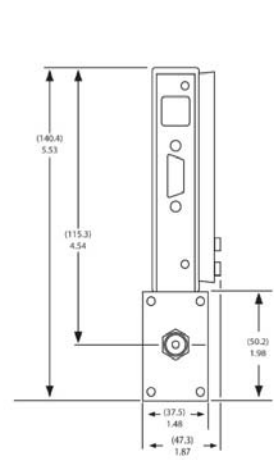

M100L & C100L Bottom View

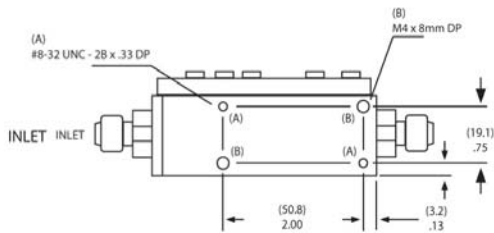

M100M & C100M Bottom View

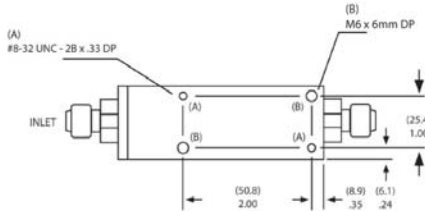

C100M Front View

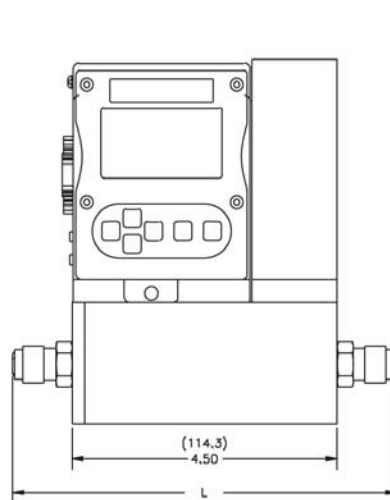

C100M Inlet View

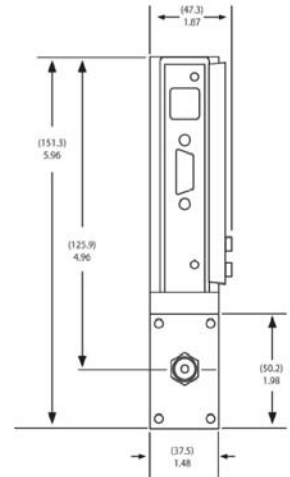

M100H,H1,H2 Front View

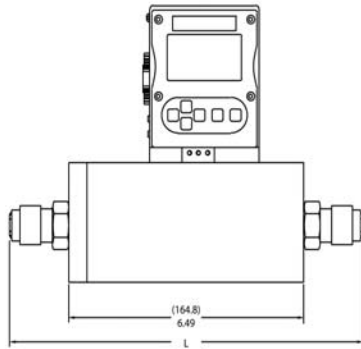

M100H,H1,H2 Side View

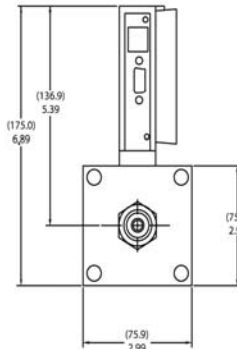

M100H,H1,H2 Bottom View

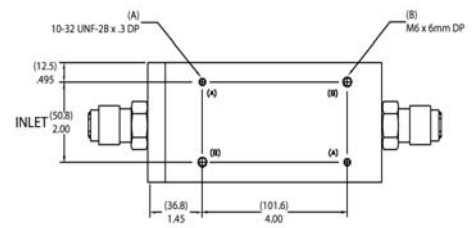

C100H Front View

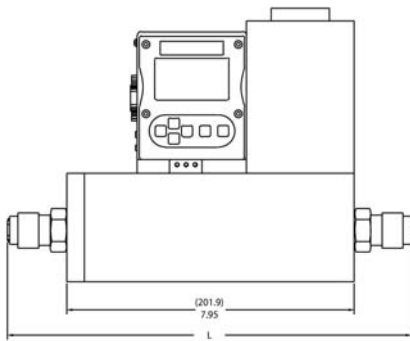

C100H Side View

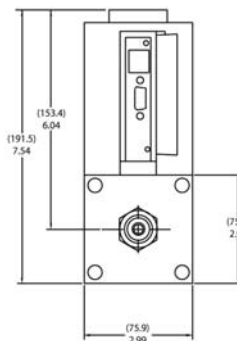

C100H Bottom View

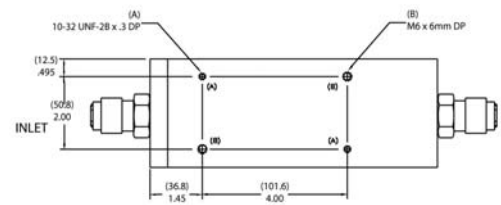

C100H1,H2 Front View

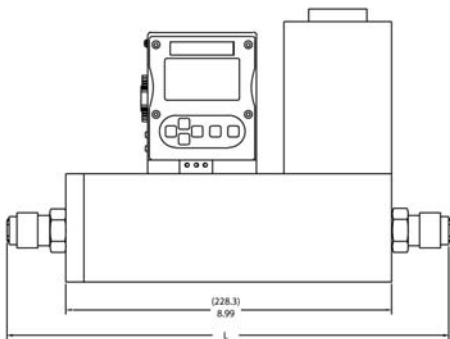

C100H1,H2 Side View

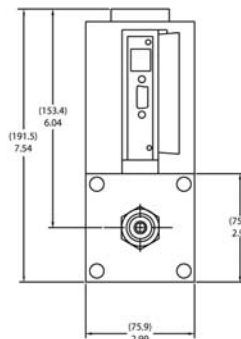

C100H1,H2 Bottom View

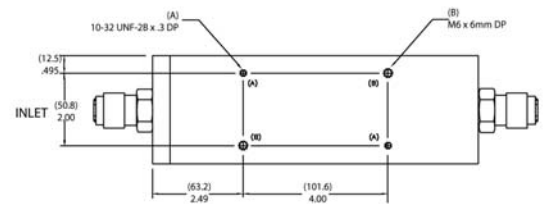

Dimension L

Fittings	Length with fittings in inches (mm)						
	C100L/M100L	C100M	M100M	M100H	M100H1, H2	C100H	C100H1, H2
1/8 compression	4.84 (124)	NA	NA	NA	NA	NA	NA
1/4 compression	5.02 (129)	6.52 (167)	6.02 (154)	NA	NA	NA	NA
3/8 compression	5.14 (132)	6.64 (170)	6.14 (157)	NA	NA	NA	NA
1/2 compression	5.3 (136)	6.80 (174)	6.30 (162)	8.92 (229)	NA	10.37 (266)	NA
1/4 VCO	4.56 (117)	6.06 (155)	5.56 (143)	NA	NA	NA	NA
1/2 VCO	5.00 (128)	6.50 (167)	6.00 (154)	8.56 (220)	NA	10.01 (257)	NA
3/4 VCO	NA	NA	NA	NA	8.78 (225)	NA	11.28 (289)
1/4 VCR	4.88 (125)	6.38 (164)	5.88 (151)	NA	NA	NA	NA
1/2 VCR	5.18 (133)	6.68 (171)	6.18 (158)	8.98 (230)	NA	10.43 (267)	NA
6 mm compression	5.04 (129)	6.54 (168)	6.04 (155)	NA	NA	NA	NA
10 mm compression	5.20 (133)	6.70 (172)	6.20 (159)	NA	NA	NA	NA
12 mm compression	5.38 (138)	6.88 (176)	6.38 (164)	8.90 (228)	NA	10.35 (265)	NA
1/4 FNPT	4.85 (124)	6.35 (163)	5.85 (150)	NA	NA	NA	NA
3/8 FNPT	NA	6.50 (167)	6.00 (154)	NA	NA	NA	NA
1/2 FNPT	NA	NA	NA	9.14 (234)	NA	10.59 (272)	NA
3/4 FNPT	NA	NA	NA	NA	9.30 (238)	NA	11.80 (303)
3/4 compression	NA	NA	NA	9.24 (237)	9.18 (235)	10.69 (274)	11.68 (300)
1 inch compression	NA	NA	NA	NA	9.52 (244)	NA	12.02 (308)

Appendix F: Micro-Trak

The information included in this section applies to the Model 101 Micro-Trak mass flow meters and controllers only.

Introduction

The Micro-Trak series of flow instruments from Sierra are designed to measure and control ultra low flows of clean gas. Special considerations must be taken to obtain optimum performance from your Model 101 Micro-Trak instrument.

Installation

Because the gas flows used with Micro-Trak are extremely small, the plumbing of these instruments has a dramatic impact on their performance. Sierra recommends all installations use tubing of 1/8 inch diameter or smaller. Larger tubing may be used, but a reduction in the response time of the instruments may be noticed. It is also important to minimize large volumes within the gas systems because these will act as manifolds and introduce delays in flow measurement and control.

Micro-Trak must be securely mounted in a location away from vibrations or it may not function normally. Periodic impacts will upset the delicate equilibrium of Micro-Trak and should be avoided.

Any gas used with Micro-Trak must be extremely clean and dry so it does not contaminate the micro passages inside the instrument. An upstream 10 micron particle filter coupled with water and oil traps are suggested.

Inlet gas pressure must be very well regulated for optimum performance from Micro-Trak. The M101 flow meter can be over-ranged by a pressure change of 10 in H₂O (0.36 psi or 25 mbar). The C101 flow controller can temporarily lose control over a similar pressure fluctuation. In either case, the Micro Trak will recover within several seconds, but a delicate process could be affected. For these reasons, caution must be taken to maintain stable pressure to obtain the excellent performance Micro-Trak was engineered to deliver.

Electrical installation is identical to other 100 Series instruments. See Chapter 2 for details.

Operation

Operation of Micro-Trak is similar to all other 100 Series instruments outlined in this manual. All functions of the Smart-Trak 2 will function with Micro-Trak and can be used with analog or digital signals, per the instructions in Chapters 3, 4 and 5.

Performance Specifications—Micro-Trak

Accuracy

± 1% of full scale including linearity at operating conditions

Dial-A-Gas

± 1% of full scale in all 10 standard gases

Repeatability

±0.2% of full scale

Temp Coeff

±0.025% of full scale per °F (±0.05% of full scale per °C) or better

Pressure coeff

±0.01% of full scale per psi (±0.15% of full scale per bar) or better

Response Time

Governed by total volume of installation. If suggestions above are followed, response time will be similar to all other Smart-Trak 2 instruments.

Operating Specifications

All clean gases, including corrosives and toxics. The following 10 gases make up the standard Dial-A-Gas feature. Alternate gases may be substituted at time of order.

Mass Flow Rates

<i>Gas</i>	<i>Micro-Trak Flow Range (sccm)</i>
<i>Air</i>	<i>0.10 – 4.0</i>
<i>Argon</i>	<i>0.14 – 5.6</i>
<i>CO₂</i>	<i>0.074 – 2.95</i>
<i>CO</i>	<i>0.10 – 4.0</i>
<i>Methane</i>	<i>0.075 – 3.0</i>
<i>Helium</i>	<i>0.14 – 5.6</i>
<i>Hydrogen</i>	<i>0.10 – 4.0</i>
<i>Oxygen</i>	<i>0.10 – 4.0</i>
<i>Nitrogen</i>	<i>0.10 – 4.0</i>
<i>N₂O</i>	<i>0.072 – 2.9</i>

Note: flow rates specified at 21°C and 760 mm Hg.

Other engineering units are available.

Gas Pressure

500 psig (34 barg) maximum pressure; burst tested to 750 psig (52 barg)

Pressure Drop Across a Micro-Trak Meter

0.36 psi (24.5 mbar) with 1/8 inch compression fittings

Differential Pressure Requirement for Micro-Trak Flow Controllers

30 psi (2040 mbar) optimum

1 psi (68 mbar) minimum with 1/8 inch compression fittings

Leak Integrity

5 X 10⁻⁹ atm cc/sec of helium maximum

Power Requirements

For Mass Flow Meters: 12-30 VDC, (230mA, regulated).

For Mass Flow Controllers:

24 VDC ±10% standard, (500mA, regulated)

15-22 VDC ±10%, (800 mA) with optional regulator

Control Range

2–100% of full scale flow; automatic shut-off at 2%.

Output Signals

Analog:

- Linear 4–20 mA, 500 ohms maximum loop resistance plus one of the following (user selectable):
- Linear 0–5 VDC, 1000 ohms minimum load resistance
- Linear 0-10 VDC, 1000 ohms minimum load resistance
- Linear 1-5 VDC, 1000 ohms minimum load resistance

Digital:

- RS-232
- Pilot module controller

Command Signal

Analog (choice of one):

- Linear 4–20 mA
- Linear 0–5 VDC
- Linear 0-10 VDC
- Linear 1-5 VDC

Digital:

- RS-232
- Pilot module controller

Physical Specifications--Wetted Materials

316 stainless steel; 416 stainless steel; synthetic ruby, Viton® “O”-rings and valve seat standard. Other elastomers are available, consult factory.

Dimensions

Same as Model C100L, M100L. See Appendix E for details.

Appendix G: Smart-Trak Basic Commands

Most Commonly Used Commands on the Smart-Trak® Series

IMPORTANT CUSTOMER NOTICE

This document is for firmware version 2.044. Sierra Instruments, Inc. reserves the right to change the command set without notification to the user. However, Sierra will also make every effort to maintain backwards compatibility with previously published command sets for Smart-Trak®. There is no implied warranty or guarantee regarding the use of this commands set. Sierra Instruments, Inc. is not liable for any damage or personal injury, whatsoever, resulting from the use of this command set.

PROTOCOL

The Smart-Trak communication is based on a standard RS232 port. All bytes are ASCII except the two CRC bytes used for a redundancy check. Each command starts with four bytes of command type, followed by a variable length value section. The two CRC bytes follow the value string and a carriage return ends the string. Each command string will vary in length but, can not exceed 26 bytes.

Command String = {4 command bytes + variable length value + 2 CRC bytes + carriage return} < 26 bytes.

The RS232 port does not depend on hardware handshaking and uses only three wires on the port: transmit, receive and ground. The port on the host needs to be configured to (9600,n,8,1) : 9600 baud, no parity, eight bit characters, one stop bit.

DESCRIPTION

Commands for the Meter. There are old commands Smart-Trak (version 1.xx) and new commands Smart-Trak 2 (version 2.xx). The 2.xx commands will support some of the 1.xx commands. If a 1.xx commands is not shown below, it is not supported in the 2.xx commands. CMNDS is a class included in the class of Meter. This page shows all types, fields, and values as derived from Meter. Version 2.xx commands that start with a '?' are read commands and commands that start with a '!' are write commands. This is list of the most commonly used commands, which are relative safe.

We can supply a list of more advanced commands, however you will need to agree to some special terms. Misuse of the Advanced commands can cause irreversible damage to the unit which would void your warranty.

FLOW

DESCRIPTION

FLOW makes the streaming mode data = flow only. If meter is in streaming mode, this data will stream until a FLOWwSETPOINT, FLOWwSETPOINTwDAC or TOTALwDIFFwDAC is sent to the meter. If not in streaming mode then one flow will be return with each FLOW command sent. ReadMeter, WriteMeter both will set flow as the streaming data.

ASCII STRING COMMANDS

'?Flow + CRC + cr' Version 2.xx read command
'!Flow + value + CRC + cr' Version 2.xx write command
'?Flow + CRC + cr' Version 1.xx read command

Returns ASCII string 'Flow + value + CRC + cr'

Values are a string of digits and an optional decimal place: '10.00'

SETPOINT

DESCRIPTION

SETPOINT sets the control setpoint. The set point is store in the flash memory. This command is not recommended for version 2.xx,. Use SETPOINT_FLASH.

ASCII STRING COMMANDS

'?Sinv + CRC + cr' Version 2.xx read command
'!Sinv + value + CRC + cr' Version 2.xx write command
'?Sinv + CRC + cr' Version 1.xx read command
'Sinv + value + CRC + cr' Version 1.xx write command

Returns ASCII string 'Sinv + valueSetpoint + CRC + cr'

Values are a string of digits and an optional decimal place: '10.00'
CRC=redundancy check bytes; cr=carrage return byte.

SETPOINT_FLASH

DESCRIPTION

SETPOINT_FLASH returns the current flash memory value setpoint with read command. The write command sets the flash memory value and makes it the active setpoint. This would be the setpoint after a power down.

ASCII String commands

'?Setf + CRC + cr' Version 2.xx read command
'!Setf + value + CRC + cr' Version 2.xx write command

Returns ASCII string 'Setf + valueSetpoint + CRC + cr'

Values are a string of digits and an optional decimal place: '10.00'
CRC=redundancy check bytes; cr=carrage return byte.

SETPOINT_RAM**DESCRIPTION**

SETPOINT_RAM returns the current ram memory value setpoint with read command. The write command sets the ram memory value and makes it the active setpoint.

ASCII STRING COMMANDS

'?Setr + CRC + cr' Version 2.xx read command

!'Setr + value + CRC + cr' Version 2.xx write command

Read returns ASCII string 'Setr + valueSetpoint + CRC + cr'

Write returns ASCII string 'Sinv + valueSetpoint + CRC + cr'

Values are a string of digits and an optional decimal place: '10.00'
CRC=redundancy check bytes; cr=carrage return byte.

UNIT_INDEX**DESCRIPTION**

UNIT_INDEX selects the units the meter displays. The index value is between 1 and 30 and is assigned as shown. scc/s = 1, scc/m = 2, scc/H = 3, Ncc/s = 4, Ncc/m = 5, Ncc/H = 6, SCF/s = 7, SCF/m = 8, SCF/H = 9, NM3/s = 10, NM3/m = 11, NM3/H = 12, SM3/s = 13, SM3/m = 14, SM3/H = 15, sl/s = 16, sl/m = 17, sl/H = 18, NL/s = 19, NL/m = 20, NL/H = 21, g/s = 22, g/m = 23, g/H = 24, kg/s = 25, kg/m = 26, kg/H = 27, lb/s = 28, lb/m = 29, lb/H = 30

ASCII STRING COMMANDS

'?Unti + CRC + cr' Version 2.xx read command

!'Unti + unitIndex + CRC + cr' Version 2.xx write command

'?Unti + CRC + cr' Version 1.xx read command

'Unti + unitIndex + CRC + cr' Version 1.xx write command

Returns ASCII string 'Unti + unitIndex + CRC + cr'

unitIndex is an integer string value of 1 to 30
CRC=redundancy check bytes; cr=carrage return byte.

VALVE_INDEX**DESCRIPTION**

VALVE_INDEX selects the state of the valve. Automatic = 1, Closed = 2, Purge = 3. This is a write to flash memory command. For version 2.xx, this command is not recommended. See VALVE_FLASH_INDEX and VALVE_RAM_INDEX.

ASCII STRING COMMANDS

'?Vlvi + CRC + cr' Version 2.xx read command
'!Vlvi + valveIndex + CRC + cr' Version 2.xx write command
'?Vlvi + CRC + cr' Version 1.xx read command
'!Vlvi + valveIndex + CRC + cr' Version 1.xx write command

Returns ASCII string 'Vlvi + valveIndex + CRC + cr'

valveIndex is an integer string value of 1 to 3
CRC=redundancy check bytes; cr=carrage return byte.

GAS_INDEX

DESCRIPTION

GAS_INDEX selects the current gas.

ASCII STRING COMMANDS

'?Gasi + CRC + cr' Version 2.xx read command
'!Gasi + gasIndex + CRC + cr' Version 2.xx write command
'?Gasi + CRC + cr' Version 1.xx read command
'!Gasi + gasIndex + CRC + cr' Version 1.xx write command

Returns ASCII string 'Gasi + gasIndex + CRC + cr'

gasIndex value is **1** through **10**
CRC=redundancy check bytes; cr=carrage return byte.

STREAM

DESCRIPTION

Communications can be in one of three mode set by this STREAM command. In off mode, the meter will respond when queried with a read command. In echo mode, the meter will respond with either a read or a write command. In stream mode, the meter will continuously send data back. If a read or write command needs to update more than one value, all values with be sent back on write command.

ASCII STRING COMMANDS

'?Strm + CRC + cr' Version 2.xx read command
'!Strm + streamString + CRC + cr' Version 2.xx write command
Returns ASCII string 'Strm + streamString + CRC + cr'
streamString = "On", "Off", "Echo"
CRC=redundancy check bytes; cr=carrage return byte.

VERSION_NUMBER**DESCRIPTION**

VERSION_NUMBER returns the firmware version. This is useful when Ver. 1.xxx and 2.xxx are in the same system to determine which command to send.

ASCII STRING COMMANDS

'?Vern + CRC + cr' Version 2.xx read command

Returns ASCII string 'Vern + alphaNumericString + CRC + cr'

alphaNumericString is alpha numeric string

CRC=redundancy check bytes; cr=carrage return byte.

SERIAL_NUMBER**DESCRIPTION**

SERIAL_NUMBER returns the serial number

ASCII STRING COMMANDS

'?SrnM + CRC + cr' Version 2.xx read command

Returns ASCII string 'SrnM + SERIAL_NUMBER + CRC + cr'

alphaNumericString is alpha numeric string

CRC=redundancy check bytes; cr=carrage return byte.

SYNC**DESCRIPTION**

Sync returns the following events, VersionNumberEvent, SerialNumberEvent, DataEvent, ManufactureNumberEvent, TypeEvent, PassWordEvent, SetpointEvent, FullScaleEvent, GasNameEvent(10 times for all gas names), GasIndexEvent, GasSpanEvent(current gas only), SetpointIndexEvent, OuputIndexEvent, UnitIndexEvent, ValveFlashEvent, StreamEvent, SyncEvent

ASCII STRING COMMANDS

'?Sync + CRC + cr' Version 2.xx read command

Returns ASCII string 'Sync + "" + CRC + cr'

SyncEvent returned last to indicate all events have been sent

CRC=redundancy check bytes; cr=carrage return byte.

ZERO

DESCRIPTION

ZERO sets the flow offset value to a zero flow reading. Warning: All flow must be shut off, the unit needs to be at pressure with the gas being used.

ASCII STRING COMMANDS

'!Zero + "" + CRC + cr' Version 2.xx write command

Returns ASCII string 'Zero + "" + CRC + cr'

CRC=redundancy check bytes; cr=carrage return byte.

RESET_ZERO

DESCRIPTION

Reset zero flow offset value to zero

ASCII STRING COMMANDS

'!Rezr + "" + CRC + cr' Version 2.xx write command

Returns ASCII string 'Rezr + "" + CRC + cr'

CRC=redundancy check bytes; cr=carrage return byte

CRC CALCULATIONS

Below is the routine used to calculate the CRC bytes in C#. Comments are between the /* */.

```

private static uint CalcCRC(byte[] cmnd)
/* cmnd is a byte array containing the command ASCII string ... cmnd[]="Sinv2.000" */
/* An unsigned 32 bit integer is return to the calling program */
/* only the lower 16 bits contain the crc */
{
    int i,j; /* interating indexes for the for loops */
    uint crc; /* crc variable that will be returned */

    crc=0xffff; /* initialize crc to hex value 0xffff */

    for (i=0; i<cmnd.Length; i++)
/* this for loop starts with ASCCCII 'S' and loops through to the last ASCII '0' */
    {
        crc=crc^((uint)(cmnd[i]*0x0100));
/* the ASCII value is times by 0x0100 first then XORED to the current crc value */
    }
}

```

```

        for(j=0; j<8; j++)
/* the crc is hashed 8 times with this for loop */
/* if the 15th bit is set (tested by ANDING with hex 0x8000 and testing for 0x8000 result)
then crc is shifted left one bit (same as times 2) XORED with hex 0x1021 and ANDED
to hex 0xffff to limit the crc to lower 16 bits. If the 15th bit is not set then the crc is shifted
left one bit and ANDED with hex 0xffff to limit the crc to lower 16 bits. */
        {
            if((crc&0x8000)==0x8000)
                crc=((crc<<1)^0x1021)&0xffff;
            else
                crc=(crc<<1)&0xffff;
        }
/* end of j loop */
/* end of i loop */
/* There are some crc values that are not allowed, 0x00 and 0x0d */
/* These are byte values so the high byte and the low byte of the crc must be checked and
incremented if the bytes are either 0x00 or 0x0d. */
        if((crc&0xff00)==0x0d00) crc +=0x0100;
        if((crc&0x00ff)==0x000d) crc +=0x0001;
        if((crc&0xff00)==0x0000) crc +=0x0100;
        if((crc&0x00ff)==0x0000) crc +=0x0001;
        return crc;
    }
/* If the string Sinv2.00 is sent through this routine the crc = 0x8f55 */
/* The complete command "Sinv2.000" will look like this in hex
0x53 0x69 0x62 0x76 0x32 0x2e 0x30 0x30 0x30 0x8f 0x55 0x0d */

```

Below is the c# routine with no comments.

```

private static uint CalcCRC(byte[] cmdnd)
{
    int i,j;
    uint crc;

    crc=0xffff;
    for (i=0; i<cmdnd.Length; i++)
    {
        crc=crc^((uint)(cmdnd[i]*0x0100));
        for(j=0; j<8; j++)
        {
            if((crc&0x8000)==0x8000)
                crc=((crc<<1)^0x1021)&0xffff;
            else
                crc=(crc<<1)&0xffff;
        }
    }
    if((crc&0xff00)==0x0d00) crc +=0x0100;
}

```



```

if((crc&0x00ff)==0x000d) crc +=0x0001;
if((crc&0xff00)==0x0000) crc +=0x0100;
if((crc&0x00ff)==0x0000) crc +=0x0001;
return crc;

```

CRC ROUTINE IN MS VISUAL BASIC:

```

Public Sub SendPacket(packet As String)
Dim crcBytes() As Byte
Dim crcLen, vpacket
Dim crcWord As Long
Dim i, j

packet = Replace(packet, ",", ".") ' if commas are used as decimal place holder
crcLen = Len(packet) - 1 ' zero based counter
ReDim crcBytes(0 To crcLen)
For i = 0 To crcLen ' convert string to bytes
    crcBytes(i) = Asc(Mid(packet, i + 1, 1)) ' get character
Next
' calc crc
crcWord = (&H1FFFE) / 2 ' not -1
For j = 0 To crcLen
    crcWord = crcWord Xor CLng(crcBytes(j)) * &H100
    For i = 1 To 8
        If (crcWord And &H8000) Then
            crcWord = (crcWord * 2) Xor &H1021 ' prime number
        Else
            crcWord = crcWord * 2
        End If
        crcWord = (((crcWord * 2) And &H1FFFE)) / 2
    Next i
Next j
If (crcWord And &HFF00) = &HD00 Then ' carriage char not allowed
    crcWord = crcWord + &H100 ' make this byte &h0exx
End If
If (crcWord And &HFF00) = &H0 Then ' zero char is death
    crcWord = crcWord + &H100 ' make this byte &h01xx
End If
If (crcWord And &HFF) = &HD Then ' carriage char not allowed
    crcWord = crcWord + 1 ' make this byte &hxx0e
End If
If (crcWord And &HFF) = &H0 Then ' zero char is death
    crcWord = crcWord + 1 ' make this byte &hxx01
End If

```

```
ReDim Preserve crcBytes(0 To crcLen + 3) ' make room for crc and carriage return
crcBytes(crcLen + 1) = Int(crcWord / &H100) ' high byte
crcBytes(crcLen + 2) = (crcWord And &HFF) ' low byte
crcBytes(crcLen + 3) = 13 ' carriage return
vpacket = crcBytes
commQueue.Add vpacket
End Sub
```