



QuadraTherm® 640i/780i Modbus

Instruction Manual

Modbus Interface Specification for Models: 640i and 780i

Thermal Mass Flow Meters



Part Number: IM640i/780i-Modbus Rev. V2
June 2019



GLOBAL SUPPORT LOCATIONS: WE ARE HERE TO HELP!

CORPORATE HEADQUARTERS

5 Harris Court, Building L Monterey, CA 93940
Phone (831) 373-0200 (800) 866-0200 Fax (831) 373-4402
www.sierrainstruments.com

EUROPE HEADQUARTERS

Bijlmansweid 2 1934RE Egmond aan den Hoef
The Netherlands
Phone +31 72 5071400 Fax +31 72 5071401

ASIA HEADQUARTERS

Second Floor Building 5, Senpu Industrial Park
25 Hangdu Road Hangtouw Town
Pu Dong New District, Shanghai, P.R. China
Postal Code 201316
Phone: + 8621 5879 8521 Fax: +8621 5879 8586

IMPORTANT CUSTOMER NOTICE- OXYGEN SERVICE

Sierra Instruments, Inc. is not liable for any damage or personal injury, whatsoever, resulting from the use of Sierra Instruments standard mass flow meters for oxygen gas. You are responsible for determining if this mass flow meter is appropriate for your oxygen application. You are responsible for cleaning the mass flow meter to the degree required for your oxygen flow application.

© COPYRIGHT SIERRA INSTRUMENTS 2019

No part of this publication may be copied, distributed, transmitted, transcribed, or stored in a retrieval system. No part of this publication may be translated into any human or computer language, in any form or by any means, electronic, mechanical, manual, or otherwise, or disclosed to third parties without the express written permission of Sierra Instruments. The information contained in this manual is subject to change without notice.

TRADEMARKS

QuadraTherm® is a trademark of Sierra Instruments, Inc. Other product and company names listed in this manual are trademarks or trade names of their respective manufacturers.

Warnings and Cautions



Warning! Agency approval for hazardous location installations varies between flow meter models. Consult the flow meter nameplate for specific flow meter approvals before any hazardous location installation.

Warning! Hot tapping must be performed by a trained professional. U.S. regulations often require a hot tap permit. The manufacturer of the hot tap equipment and/or the contractor performing the hot tap is responsible for providing proof of such a permit.

Warning! All wiring procedures must be performed with the power off.

Warning! To avoid potential electric shock, follow National Electric Code safety practices or your local code when wiring this unit to a power source and to peripheral devices. Failure to do so could result in injury or death. All AC power connections must be in accordance with published CE directives.

Warning! Do not power the flow meter with the sensor remote (if applicable) wires disconnected. This could cause overheating of the sensors and/or damage to the electronics.

Warning! Before attempting any flow meter repair, verify that the line is de-pressurized.

Warning! Always remove main power before disassembling any part of the mass flow meter.



Caution! Before making adjustments to the device, verify the flow meter is not actively monitoring or reporting to any master control system. Adjustments to the electronics will cause direct changes to flow control settings.

Caution! All flow meter connections, isolation valves and fittings for hot tapping must have the same or higher pressure rating as the main pipeline.

Caution! Changing the length of cables or interchanging sensors or sensor wiring will affect the accuracy of the flow meter. You cannot add or subtract wire length without returning the meter to the factory for re-calibration.

Caution! When using toxic or corrosive gases, purge the line with inert gas for a minimum of four hours at full gas flow before installing the meter.

Caution! The AC wire insulation temperature rating must meet or exceed 80°C (176°F).

Caution! Printed circuit boards are sensitive to electrostatic discharge. To avoid damaging the board, follow these precautions to minimize the risk of damage:

- before handling the assembly, discharge your body by touching a grounded, metal object
- handle all cards by their edges unless otherwise required
- when possible, use grounded electrostatic discharge wrist straps when handling sensitive components

Note and Safety Information

We use caution and warning statements throughout this book to draw your attention to important information.



Warning!

This statement appears with information that is important to protect people and equipment from damage. Pay very close attention to all warnings that apply to your application.



Caution!

This statement appears with information that is important for protecting your equipment and performance. Read and follow all cautions that apply to your application.

Receipt of System Components

When receiving a Sierra mass flow meter, carefully check the outside packing carton for damage incurred in shipment. If the carton is damaged, notify the local carrier and submit a report to the factory or distributor. Remove the packing slip and check that all ordered components are present. Make sure any spare parts or accessories are not discarded with the packing material. Do not return any equipment to the factory without first contacting Sierra's Customer Service Department.

Technical Assistance

If you encounter a problem with your flow meter, review the configuration information for each step of the installation, operation, and setup procedures. Verify that your settings and adjustments are consistent with factory recommendations. Installation and troubleshooting information can be found in the [QuadraTherm® 640i/780i](#) Series product manual.

If the problem persists after following the troubleshooting procedures outlined in the 640i or 780i product manuals, contact Sierra Instruments by fax or by e-mail (see inside front cover). For urgent phone support, you may call (800) 866-0200 or (831) 373-0200 between 8:00 a.m. and 5:00 p.m. PST. In Europe, contact Sierra Instruments Europe at +31 20 6145810. In the Asia-Pacific region, contact Sierra Instruments Asia at +86-21-58798521. When contacting Technical Support, make sure to include this information:

- The flow range, serial number, and Sierra order number (all marked on the meter nameplate)
- The software version (visible at start up)
- The problem you are encountering and any corrective action taken
- Application information (gas, pressure, temperature and piping configuration)

Table of Contents

Chapter 1- Introduction	6
Chapter 2 - Electrical Connections.....	7
RS-485 Connection	7
General 2-Wire Topology RS-485 Network	9
Chapter 3 - Communicating	11
Data Format Type for Various Registers.....	11
Modbus Registers Overview	11
Registers Explained.....	14
Register Descriptions.....	14
Chapter 4 - Bootloader	23
Introduction	23
Getting Started.....	23
Load Firmware	24
Setup Firmware	26
Quit.....	28
Troubleshooting.....	28

Chapter 1- Introduction

Modbus is a serial communications protocol first published by Modicon in 1979 for use with its programmable logic controllers (PLCs). It's simple and robust, royalty free and it has since become a de facto standard communication protocol, and it is now a commonly available means of connecting industrial electronic devices in the USA.

Modbus allows for communication between many devices (nodes) connected to the same network. Modbus is often used to connect a supervisory computer with a remote terminal unit (RTU) in supervisory control and data acquisition (SCADA) systems. It supports many data types, Including:

- Floating point IEEE 754 (Real)
- 32-bit integer
- 8-bit ASCII data
- 16-bit integer
- Mixed data types
- Bit fields in integers
- Multipliers to change data to/from integer. 10, 100, 1000, 256 ...

The Modbus interface discussed in this manual is an option for Sierra Instruments' QuadraTherm 640i/780i four-sensor thermal mass flow meter. The interface makes it possible to connect the QuadraTherm to a Modbus network and remotely operate it.

For more information about Modbus, visit their website at <http://www.Modbus.org/>.



Note

To fully understand the QuadraTherm and its functions it is advised to also read the QuadraTherm instruction manual.

Chapter 2 - Electrical Connections

All electrical connections are made on the terminal board inside the QuadraTherm enclosure.

Instrument Power Connection

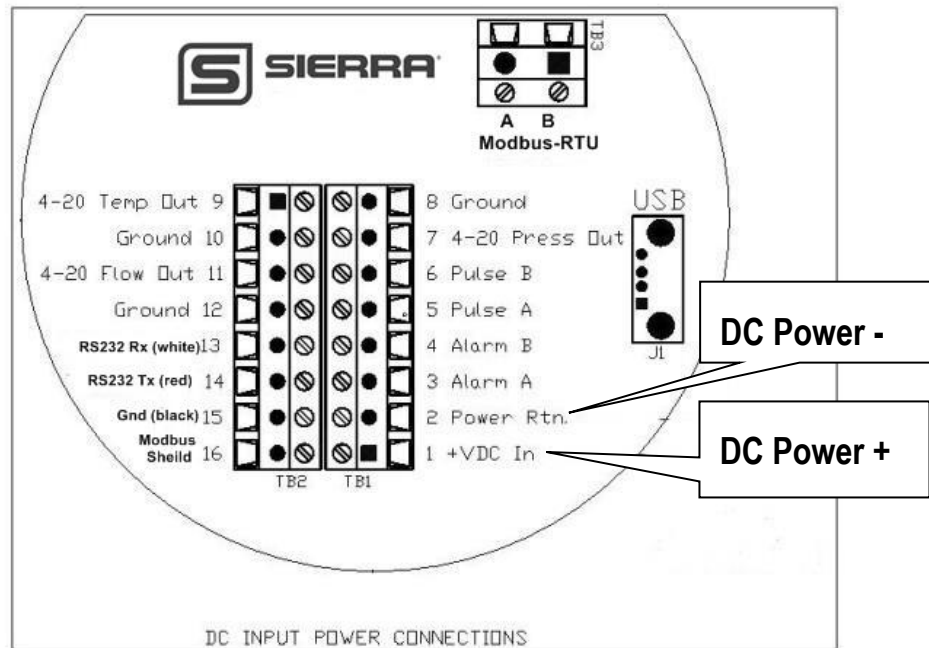

Power supply requirements for the QuadraTherm are the following:

- Voltage: 24 VDC +/- 10%,
- Amperage: 1.1 A

Modbus RS-485 Connection

	<p>Caution</p> <p>The QuadraTherm is equipped with an optical isolated RS-485 interface. Grounding the Modbus shield (16) would defeat this.</p>
--	---

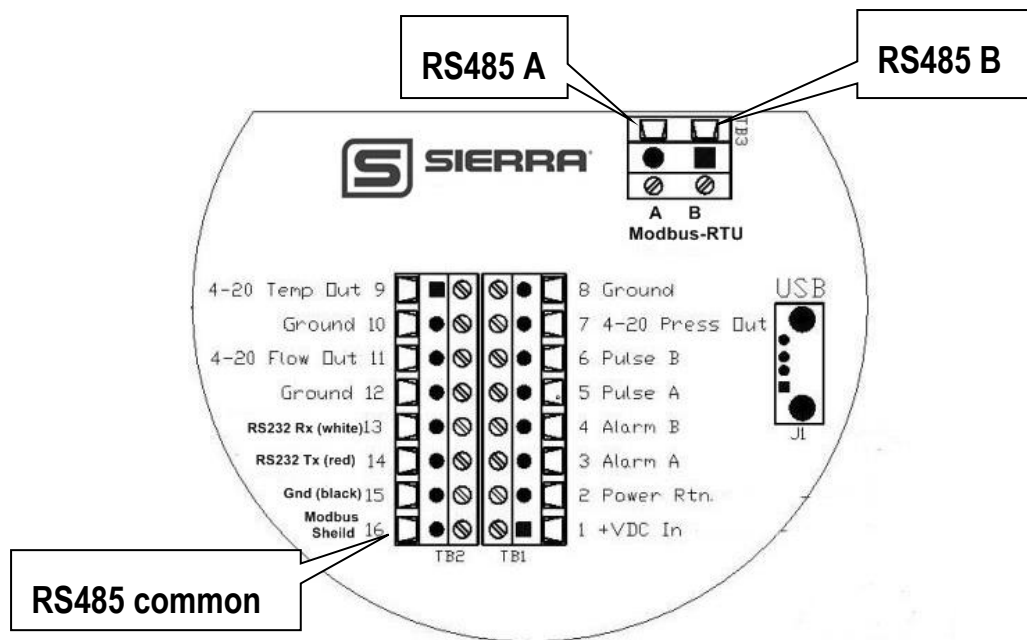

Connecting the RS-485 to Your QuadraTherm

1. Connect your 2-wire RS-485 A (-) to the A terminal and the 2-wire RS-485 B (+) to the B terminal. Occasionally you may find a Modbus device from another manufacturer labeled A+ and B-, in that case the A and B terminals need to be swapped.
 2. Connect the RS-485 common (C or shield) to the Modbus Shield on terminal 16.
 3. The meter's Modbus Address, Baud Rate, and Parity are set using the bootloader, see Chapter 4. You should do this before connecting to the full RS485 network.
1. **Cabling Summary**
Use a 24 AWG shielded twisted pair cable, with low capacitance, 120Ω impedance like Belden 9841.
 2. Never put the Modbus wires in the same conduit as AC power. Ideally DC power wires should be run in separate conduit if possible, to prevent interference issues.
 3. Both ends of the RS485 network cable should have 120 Ω resistors to prevent reflections. Before the network is running you should be able to verify this with a simple DMM. You should measure about 60Ω total. (Two 120Ω resistors in parallel)
 4. Terminal labeled A & B will be connected to the twisted wire pair in the center of the cable.
 5. The cable shield wire needs be connected terminal 16. It's better if it is not connected to Earth ground. However, some other Modbus devices on your network may already Earth grounded this shield. This is still acceptable, but it best that this device is near the master.
 6. Wires between Modbus devices need to be wired in a daisy-chain pattern. They should never be wired with separate home-runs back to the master in a Star pattern. When daisy chaining the Modbus A/B wires you should either twist the wires together and solder or use a crimp ferrule, this would still allow the bus to be connected even if the meter A/B wires were disconnected.
 7. Keep the wires as short as possible inside the enclosure and maintain the A/B wire twist as much as possible.
 8. The meter enclosure must always be Earth grounded. This prevents Electrostatic and Electromagnetic noise from interfering and the meter's microprocessor and with the Modbus data. In addition, it also provides for safety, EMI, RFI, and ESD protection.

Both the main and remote (if E4 option ordered) enclosures should be connected to earth ground, see below for more details.

- A. External Earthing: The external earthing connections are located on the boss on the outside of both the main housing and remote housing (E4 option if ordered) and consist of an 18-8SS pan head Phillips screw (10-24 UNC-2B thread) and a serrated tooth #10 ring terminal for 16-14 AWG wire.
- B. Internal Earthing: The internal earthing connection is located in the main housing terminal side and consist of an 18-8SS pan head Phillips screw (10-24 UNC-2B thread) and a serrated tooth #10 ring terminal for 16-14 AWG wire.

General 2-Wire Topology RS-485 Network

Modbus-RTU uses a common 2-wire RS-485 network for its physical layer. RS-485 is simple and robust. For short wire runs and lower baud rates it is very forgiving.

RS-485 only specifies electrical characteristics of the Master and the Slave. It does not specify or recommend any communications protocol or Data Link layer. Unlike proprietary RS-485 based field buses; Modbus uses the same Data Link layer used by PCs. This allows you to be able to use cheap USB to RS485 adapters as a Modbus master.

The RS-485 bus needs to be wired in a daisy chain pattern between devices. If stub wires are necessary, they cannot be more the 10 cm long.

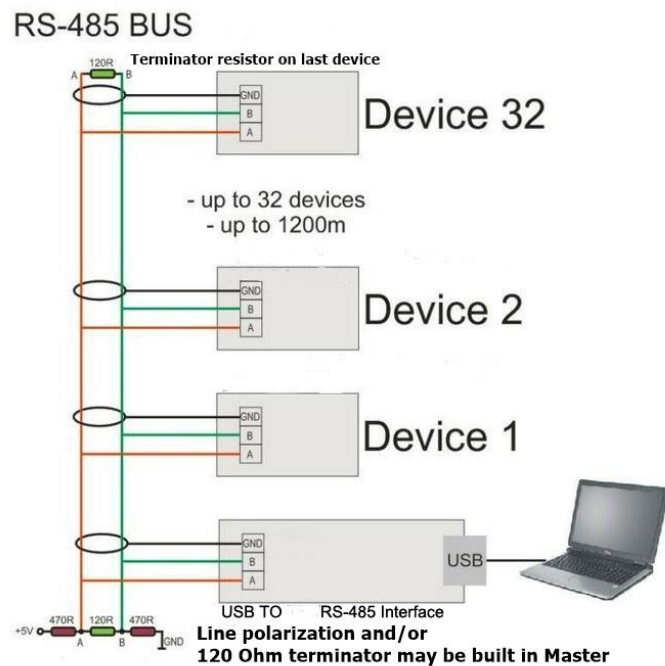

Cable

It is recommended to use shielded twisted pair type of cable (reduces radiated and received EMI). Use a 24 AWG shielded twisted pair cable, with low capacitance like Belden 9841.

Terminator

Reflections in a transmission line can cause communication errors. To minimize the reflection it is required to place 120Ω terminator resistors at both ends of the cable. Never place a terminator resistor in the middle of the network. Some Gateways, PLC, and other types of Modbus masters have terminator resistors built-in. If so, do not add another one. Using an Oscilloscope you can see what a reflection looks like, and how it can confuse the data:

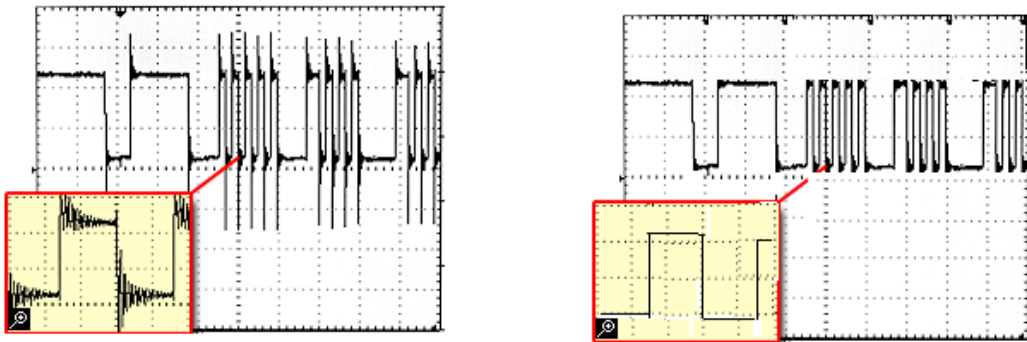

Not terminated

Properly Terminated

Line Polarization

RS-485 has 3 voltage levels, “1” , “0” , and idle. In noisy environments it may be necessary to polarize the lines to ensure that the idle stays low so all the slave devices on the network stay in the listen mode, waiting for their address to be called.

Most master devices have this already built in. In very noisy cases you may need make circuit do this. However, a commercially available isolated RS485 repeater in the middle of your wire run will “clean up” the signals and polarize the idle voltage. This is also very useful for long wire runs. A repeater also allows you to add another 32 devices.

Shield Wire Grounding

We use a RS485 chip that has 1,500 Volts of isolation. For electrical noise it’s best to keep the shield wire isolated from Earth ground and only connect it to terminal 16 and the signal ground at the Master.

Occasionally, you may have no choice but share the Modbus network with a device that has a non-isolated RS485 chip. Usually you can get by with this. It is best for this non-isolated device to be the first device on the network. If you have trouble, you may need to use an isolated RS485 repeater to separate it from the rest of the network.

Chapter 3 - Communicating

Once the QuadraTherm is wired to the network and powered up, it is time to communicate with it. The factory default settings for the Modbus interface are the following:

- ID code = 1
- Baud rate = 19200
- Parity = Even
- Number of bits = 8
- Stop bit = 1
- Delay between receiving and transmitting = 8 ms

The above Modbus settings are the factory defaults and can be changed. The changes can be done through the boot loader.

Data Format Type for Various Registers

The following are data format various registers available:

- **32 bit real:** IEEE 754 floating point, low word first
- **16 bits integer:** unsigned integer values
- **16 bits ASCII:** ASCII encoded characters, high word = 1st character (0x4944 = “ID”)

Modbus Registers Overview

PDU Address	Register	Description	Read/Write	Type	No. registers*
\$00	40001	Actual flow - low word	R	32 bits real	2
\$01	40002	Actual flow - high word	R		
\$02	40003	Actual temp - low word	R	32 bits real	2
\$03	40004	Actual temp - high word	R		
\$04	40005	Actual pressure - low word	R	32 bits real	2
\$05	40006	Actual pressure - high word	R		
\$06	40007	Actual total - low word	R	32 bits real	2
\$07	40008	Actual total - high word	R		
\$08	40009	Alarm status	R	integer	1
\$09	40010	Gas name	R	16 bits ASCII	8
~					
\$10	40017				
\$11	40018	Gas index	R/W	integer	1
\$12	40019	Flow units	R	16 bits ASCII	4
~					
\$15	40022				
\$16	40023	Flow unit - index	R/W	integer	1
\$17	40024	User full scale – low word	R/W	32 bits real	2
\$18	40025	User full scale – high word	R/W		
\$19	40026	Totalizer units	R	16 bits ASCII	2
\$1A	40027				
\$1B	40028	Totalizer unit - index	R	integer	1

\$1C	40029	Temperature units	R	16 bits ASCII	1
\$1D	40030	Temperature unit - index	R/W	integer	1
\$1E	40031	Pressure units	R	16 bits ASCII	4
~					
\$21	40034				
\$22	40035	Pressure unit - index	R/W	integer	1
\$23	40036	Standard Temperature - low word	R/W	32 bits real	2
\$24	40037	Standard Temperature - high word	R/W		
\$25	40038	Standard Temperature - index	R/W	integer	1
\$26	40039	Standard pressure - low word	R/W	32 bits real	2
\$27	40040	Standard pressure - high word	R/W		
\$28	40041	Standard pressure - index	R/W	integer	1
\$29	40042	Normal Temperature - low word	R/W	32 bits real	2
\$2A	40043	Normal Temperature - high word	R/W		
\$2B	40044	Normal Temperature - index	R/W	integer	1
\$2C	40045	Normal pressure - low word	R/W	32 bits real	2
\$2D	40046	Normal pressure - high word	R/W		
\$2E	40047	Normal pressure - index	R/W	integer	1
\$2F	40048	Adjust DAC for flow – 4mA	R/W	integer	1
\$30	40049	Adjust DAC for flow – 20mA	R/W	integer	1
\$31	40050	Adjust DAC for Temperature – 4mA	R/W	integer	1
\$32	40051	Adjust DAC for Temperature – 20mA	R/W	integer	1
\$33	40052	Adjust DAC for pressure – 4mA	R/W	integer	1
\$34	40053	Adjust DAC for pressure – 20mA	R/W	integer	1
\$35	40054	Temperature 4mA value – low word	R/W	32 bits real	2
\$36	40055	Temperature 4mA value – high word	R/W		
\$37	40056	Temperature 20mA value – low word	R/W	32 bits real	2
\$38	40057	Temperature 20mA value – high word	R/W		
\$39	40058	Pressure 4mA value – low word	R/W	32 bits real	2
\$3A	40059	Pressure 4mA value – high word	R/W		
\$3B	40060	Pressure 20mA value – low word	R/W	32 bits real	2
\$3C	40061	Pressure 20mA value – high word	R/W		
\$3D	40062	Alarm active	R/W	integer	1
\$3E	40063	Alarm mode	R/W	integer	1
\$3F	40064	Low alarm flow trig – low word	R/W	32 bits real	2
\$40	40065	Low alarm flow trig – high word	R/W		
\$41	40066	High alarm flow trig – low word	R/W	32 bits real	2
\$42	40067	High alarm flow trig – high word	R/W		
\$43	40068	Low alarm temp trig – low word	R/W	32 bits real	2
\$44	40069	Low alarm temp trig – high word	R/W		
\$45	40070	High alarm temp trig – low word	R/W	32 bits real	2
\$46	40071	High alarm temp trig – high word	R/W		
\$47	40072	Low alarm pressure trig – low word	R/W	32 bits real	2
\$48	40073	Low alarm pressure trig – high word	R/W		
\$49	40074	High alarm pressure trig – low word	R/W	32 bits real	2
\$4A	40075	High alarm pressure trig – high word	R/W		
\$4B	40076	Low alarm total trig – low word	R/W	32 bits real	2
\$4C	40077	Low alarm total trig – high word	R/W		
\$4D	40078	High alarm total trig – low word	R/W	32 bits real	2
\$4E	40079	High alarm total trig – high word	R/W		
\$4F	40080	Pipe diameter – low word	R/W	32 bits real	2
\$50	40081	Pipe diameter – high word	R/W		
\$51	40082	Pipe roughness	R/W	integer	1

\$52	40083	Pipe diameter units - index	R/W	integer	1
\$53	40084	Flow correction – low word	R/W	32 bits real	2
\$54	40085	Flow correction – high word	R/W		
\$55	40086	Totalizer enable	R/W	integer	1
\$56	40087	Totalizer buck – low word	R/W	32 bits real	2
\$57	40088	Totalizer buck – high word	R/W		
\$58	40089	Totalizer pulse width	R/W	integer	1
\$59	40090	Totalizer reset	R/W	integer	1
\$5A	40091	Password	R/W	integer	1
\$5B	40092	Standard temperature units	R	16 bits ASCII	1
\$5C	40093	Normal temperature units	R	16 bits ASCII	1
\$5D	40094	Standard pressure units	R	16 bits ASCII	4
~					
\$60	40097				
\$61	40098	Normal pressure units	R	16 bits ASCII	4
~					
\$64	40101				
\$65	40102	Pipe diameter units	R	16 bits ASCII	2
\$66	40103				
\$67	40104	Pipe roughness description	R	16 bits ASCII	5
~					
\$6B	40108				
\$6C	40109	Alarm status	R	16 bits ASCII	2
\$6D	40110				
\$6E	40111	Alarm active	R	16 bits ASCII	2
\$6F	40112				
\$70	40113	Alarm mode	R	16 bits ASCII	3
~					
\$72	40115				
\$73	40116	Serial number	R	16 bits ASCII	4
~					
\$76	40119				
\$77	40120	Firmware version	R	16 bits ASCII	4
~					
\$7A	40123				
\$7B	40124	Calibration date	R	16 bits ASCII	5
~					
\$7F	40128				
\$80	40129	PCA version	R	16 bits ASCII	3
~					
\$82	40131				

* Note: Exceeding the numbers of [suggested](#) registers will raise an exception code.

Registers Explained

The registers are divided into two groups. The first group (40001 – 40009) represents the dynamic data and changes the most of the two groups. The second group (40010 – 40131) contains the settings of the QuadraTherm meter.



Note

To fully understand the registers and their functions, we suggest you also read the QuadraTherm instruction manual.

Register Descriptions

40001: Actual Flow

The actual flow as measured by the instrument.

40003: Actual Temperature

The actual gas temperature as measured by the instrument.

40005: Actual Pressure

The actual pressure as measured by the instrument (if applicable).

40009: Alarm Status

Value representing the status of the alarm:

0 – Alarm Off/Inactive

1 – Alarm is On/Active

40010 - 40017: Gas Name

40010-40017 Registers are an ASCII string showing the name of the currently selected gas. Use register 40018 to select a different gas.

40018: Gas Index

Value indicates which gas is selected on the instrument. The value can range between 0 and 3. 0 is always Air and 1-3 are the alternate gases.

40019: Flow Units

ASCII string shows the currently selected flow engineering unit on the instrument. Use Register 40023 to select a different flow unit

40023: Flow Unit Index

Value shows which flow unit is selected on the instrument. The value can range between 0 and 49:

- 0 – SCFS
- 1 – SCFM
- 2 – SCFH
- 3 – SCFD
- 4 – SCFY
- 5 – NCFS
- 6 – NCFM
- 7 – NCFH
- 8 – NCFD
- 9 – NCFY
- 10 – SM3/Sec
- 11 – SM3/Min
- 12 – SM3/Hour
- 13 – SM3/Day
- 14 – SM3/Year
- 15 – NM3/Sec
- 16 – NM3/Min
- 17 – NM3/Hour
- 18 – NM3/Day
- 19 – NM3/Year
- 20 – SLPS
- 21 – SLPM
- 22 – SLPH
- 23 – SLPD
- 24 – SLPY
- 25 – NLPS
- 26 – NLPM
- 27 – NLPH
- 28 – NLPD
- 29 – NLPY
- 30 – Lbs/Sec
- 31 – Lbs/Min
- 32 – Lbs/Hour
- 33 – Lbs/Day
- 34 – Lbs/Year
- 35 – Kg/Sec
- 36 – Kg/Min
- 37 – Kg/Hour
- 38 – Kg/Day
- 39 – Kg/Year
- 40 – SFPS
- 41 – SFPM
- 42 – SFPH
- 43 – SFPD
- 44 – SFPY
- 45 – SMPS
- 46 – SMPM
- 47 – SMPH
- 48 – SMPD
- 49 – SMDY



Warning!

The totalizer will not work when the velocity units are selected (units 40-49).

40024: User Full Scale

Register 40024 is the “4-20 Flow Out” full scale value. Changing this only affects the 4-20 flow output and will not affect the Modbus data.

40026: Totalizer Flow Units

ASCII string shows the currently selected totalizer unit on the instrument. The unit is linked to the flow unit. Changing the flow unit will change the totalizer unit.

40028: Totalizer Unit Index

Value shows which unit is selected on the instrument (read only). These correspond with the Flow Unit Index with the integral time stripped off. Examples: 1= SCFM flow unit or SCF total unit, 2= SCFH flow unit or SCF total unit.

40029: Temperature Unit

ASCII data string shows the currently selected temperature unit on the instrument. Use Register 40030 to select a different unit.

40030: Temperature Unit Index

Value shows which temperature unit is selected on the instrument:

- 0 – F
- 1 – C
- 2 – K
- 3 – R

40031: Pressure Unit

ASCII string shows the currently selected pressure unit on the instrument. Use register 40035 to select a different unit

40035: Pressure Unit Index

Value shows which pressure unit is selected on the instrument:

- 0 – PSIA
- 1 – PSIG
- 2 – Bar A
- 3 – Bar G
- 4 – KPa A
- 5 – KPa G
- 6 – Kg

40036: Standard Temperature

Value shows the standard temperature.

40038: Standard Temperature Unit Index

Value shows which temperature unit is selected as standard temperature:

- 0 – F
- 1 – C
- 2 – K
- 3 – R

40039: Standard Pressure

Value shows the standard pressure.

40041: Standard Pressure Index

Value shows which pressure unit is selected as the standard pressure:

- 0 – PSIA
- 1 – PSIG
- 2 – Bar A
- 3 – Bar G
- 4 – KPa A
- 5 – KPa G
- 6 – Kg

40042: Normal Temperature

Value shows the normal temperature.

40044: Normal Temperature Unit Index

Value shows which temperature unit is selected as the normal temperature:

- 0 – F
- 1 – C
- 2 – K
- 3 – R

40045: Normal Pressure

Value shows the normal pressure.

40047: Normal Pressure Index

Value shows which pressure unit is selected as the normal pressure:

- 0 – PSIA
- 1 – PSIG
- 2 – Bar A
- 3 – Bar G
- 4 – KPa A
- 5 – KPa G
- 6 – Kg

	<p>Note</p> <p>Registers 40048 to 40060 only affect the three 4-20mA outputs on the meter, and have would have no effect on the Modbus data.</p>
---	---

40048: Flow - 4ma Tuning

DAC value that represents 4 mA for the flow output

40049: Flow - 20ma Tuning

DAC value that represents 20 mA for the flow output

40050: Temperature - 4ma Tuning

DAC value that represents 4 mA for the temperature output

40051: Temperature - 20ma Tuning

DAC value that represents 20 mA for the temperature output

40052: Pressure - 4ma Tuning

DAC value that represents 4 mA for the pressure output

40053: Pressure - 20ma Tuning

DAC value that represents 20 mA for the pressure output

40054: Temperature - 4ma Value

Temperature value that 4mA equals

40056: Temperature - 20ma Value

Temperature value that 20mA equals

40058: Pressure - 4ma Value

Pressure value that 4mA equals

40060: Pressure - 20ma Value

Pressure value that 20mA equals

40062: Alarm Active

Value indicates which alarm is active (see below). Note: Only one alarm can be active when the instrument is online.

- 0 - Off
- 1 - Always On (use this to test the alarm circuit)
- 16 - Flow
- 32 - Pressure
- 64 - Temperature
- 128 - Totalizer

40063: Alarm Mode

Value indicates the mode of the current active alarm (flow, temperature, pressure or totalizer):

- 0 – Alarm set to “Low” mode
- 1 – Alarm set to “High” mode
- 2 – Alarm set to “Window”

The Window Mode (2) is a combination of both “Low” and “High” alarm modes working together. You will need to provide both “Low” and “High” threshold values for this mode to work correctly. Example: If the “Low” is set to 10 and the “High” is set to 20, the alarm will only be active below 10 and above 20.

40064: Flow – Low Alarm Threshold

Value at which the low alarm is triggered

40066: Flow – High Alarm Threshold

Value at which the high alarm is triggered

40068: Temperature – Low Alarm Threshold

Value at which the low alarm is triggered

40070: Temperature – High Alarm Threshold

Value at which the high alarm is triggered

40072: Pressure – Low Alarm Threshold

Value at which the low alarm is triggered

40074: Pressure – High Alarm Threshold

Value at which the high alarm is triggered

40076: Total – Low Alarm Threshold

Value at which the low alarm is triggered

40078: Total – High Alarm Threshold

Value at which the high alarm is triggered

40080: Pipe Diameter

Value of the pipe diameter will be in the units that are currently active.

40082: Pipe Roughness

Value indicates the pipe material:

- 0 – PVC
- 1 – Glass
- 2 – Stainless steel-smooth
- 3 – Stainless steel -normal
- 4 – Stainless steel -rough
- 5 – Carbon steel -smooth
- 6 – Carbon steel -normal
- 7 – Carbon steel -rough
- 8 – Carbon-fiber
- 9 – cast-iron
- 10 – concrete

40083: Pipe Diameter Units

Value indicates the current pipe diameter units:

- 0 – Inches
- 1 – Feet
- 2 – Millimeters
- 3 – Meters

40084: Flow Correction

This value is used to alter the flow reading (default = 1.0)

40086: Enable Totalizer

Enable or disable the totalizer:

0 = off

1 = on

40087: Totalizer units per pulse

This is the value that determines when the totalizer output will pulse. Maximum frequency of the pulse output is 1 Hz.

40089: Totalizer Pulse Output Width

Value which indicates the pulse width of the pulse output:

- 0 – Off
- 1 – On used for testing
- 2 – 50ms
- 3 – 100ms
- 4 – 250ms

40090: Totalizer Reset

Write any value to reset the totalizer.

40091: Password

This register shows the currently active password. Note: the password is only used to control access to the display module.

40092: Standard Temperature Unit

ASCII string shows the temperature unit of the standard temperature:

- F
- C
- K
- R

40093: Normal Temperature Unit

ASCII string shows the temperature unit of the normal temperature:

- F
- C
- K
- R

40094: Standard Pressure Unit

ASCII string shows the pressure unit of the standard pressure:

- Psia
- Psig
- Bar A
- Bar G
- KPa A
- KPa G
- Kg/CM2 A
- Kg/CM2 G
- In H20 A
- In H20 G
- MM H20 A
- MM H20 G

40098: Normal Pressure Unit

ASCII string shows the pressure unit of the normal pressure:

- Psia
- Psig
- Bar A
- Bar G
- KPa A
- KPa G
- Kg/CM2 A
- Kg/CM2 G
- In H20 A
- In H20 G

- MM H20 A
- MM H20 G

40102: Pipe Diameter Units

ASCII string shows the pipe diameter units:

- Inches
- Feet
- Millimeters
- Meters

40104: Pipe Roughness Description

ASCII string shows the selected pipe roughness:

- PVC
- Glass
- Stainless steel-smooth
- Stainless steel -normal
- Stainless steel -rough
- Carbon steel -smooth
- Carbon steel -normal
- Carbon steel -rough
- Carbon-fiber
- Cast-iron
- Concrete

40109: Alarm Status Description

ASCII string shows the alarm status:

- Off
- On

40111: Alarm Active Description

ASCII string shows the active alarm:

- Off
- Always On
- Flow
- Pressure
- Temperature
- Totalizer

40113: Alarm Mode Description

ASCII string shows the alarm mode:

- Low
- High
- Window

40116: Serial Number

ASCII string shows the serial number of the unit.

40120: Firmware Revision

ASCII string shows the firmware version of the unit.

40124: Calibration Date

ASCII string shows the date the unit was calibrated.

40129: PCA Version

ASCII string shows the revision number of the PCA.

Chapter 4 - Bootloader

Introduction

This chapter describes how the boot loader is used. The boot loader makes it possible to set up the Modbus interface and download the instrument firmware using a simple terminal program and a serial connection.

Getting Started

In order to use the Boot loader, a PC equipped with a 2-wire RS-485 interface is required. This could be an internal RS-485 card, an external RS232(COM Port) to RS-485 converter, or an external USB to RS-485 converter .

1. Connect the RS-485 interface to the A and B terminals of the QuadraTherm. See Modbus connections in Chapter 2.
2. You will need a simple terminal emulator program. The examples below use Microsoft HyperTerminal. It was included with Windows XP and earlier versions of Windows. However, Windows 7 & 8 did not include it. You can either use another terminal program or copy hypertrm.exe and hypertrm.dll from a XP system.

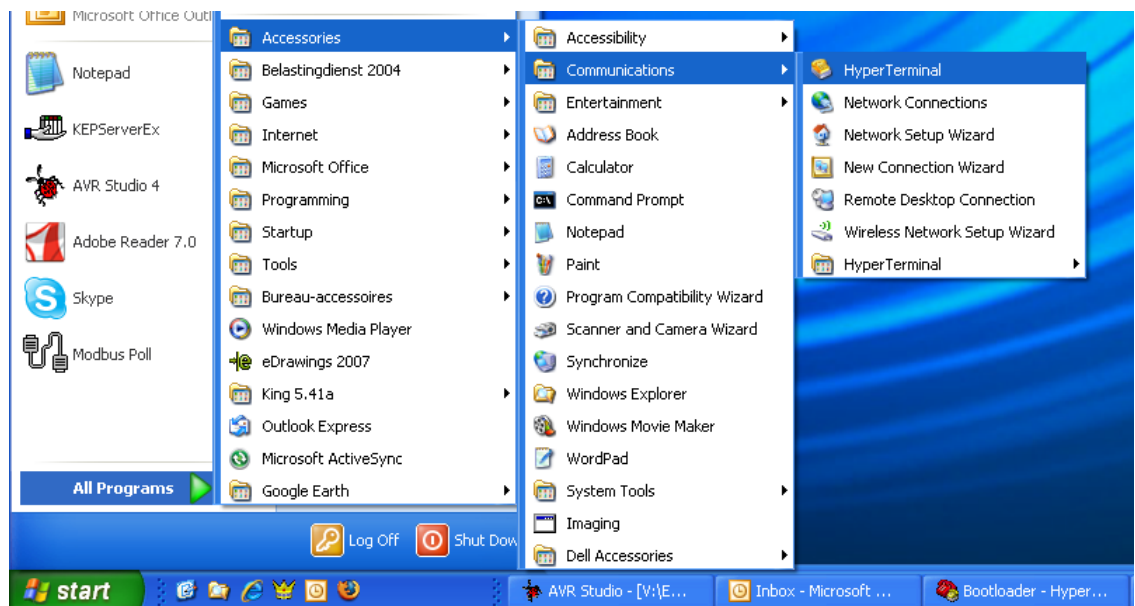

3. Start HyperTerminal from windows, and select the com port to which the RS-485 interface is connected. Use the following settings:

Bits per Second : 9600
Data Bits : 8
Parity : N
Stop bits : 1
Flow control :None

The bootloader will only be active during the first two seconds after a power-up of the flow meter. To activate the bootloader, follow the instructions below:

1. Power up the meter.
2. In HyperTerminal, press the enter key within two seconds of powering up the meter.
3. When the bootloader is successfully activated, the following menu will be presented on the screen:

```

Bootloader - HyperTerminal
File Edit View Call Transfer Help
Boot 1.0
1)Load Firmware
2)Setup Firmware
3)Quit
>_

```

4. On the menu, the version of the bootloader is shown with ~~and~~ three options. Select what action you want to take, by entering either “1”, “2” or “3.”

Load Firmware

1. The firmware was already loaded at the factory, loading firmware is only necessary to update the firmware. Press “1” to download firmware to the unit. The following screen will show in the bootloader:

```

Bootloader - HyperTerminal
File Edit View Call Transfer Help
Boot 1.0
1)Load Firmware
2)Setup Firmware
3)Quit
>1
>Are you sure Y/N?_

```

2. Once you select an option, confirm your selection by answering the question that will appear on the screen by pressing the “Y” key to continue or pressing the “n” key to abort.
3. After you confirm your selection, the following screen will appear:

```

Bootloader - HyperTerminal
File Edit View Call Transfer Help
Boot 1.0
1)Load Firmware
2)Setup Firmware
3)Quit
>1
>Are you sure Y/N?Y
>Start XMODEM(ESC to abort):$$$$$$$$$

```

4. The screen will start to fill up with the “\$” character indicating that the XMODEM transfer can be started. Press the “ESC” key to abort (if needed).

- From the “Transfer” menu select “Send file.”

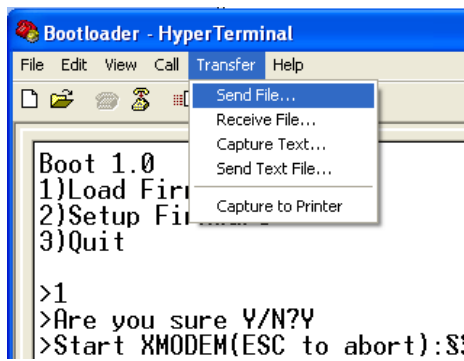

- A pop up window entitled “Send File” will open. Use this screen to get the file to be transferred.

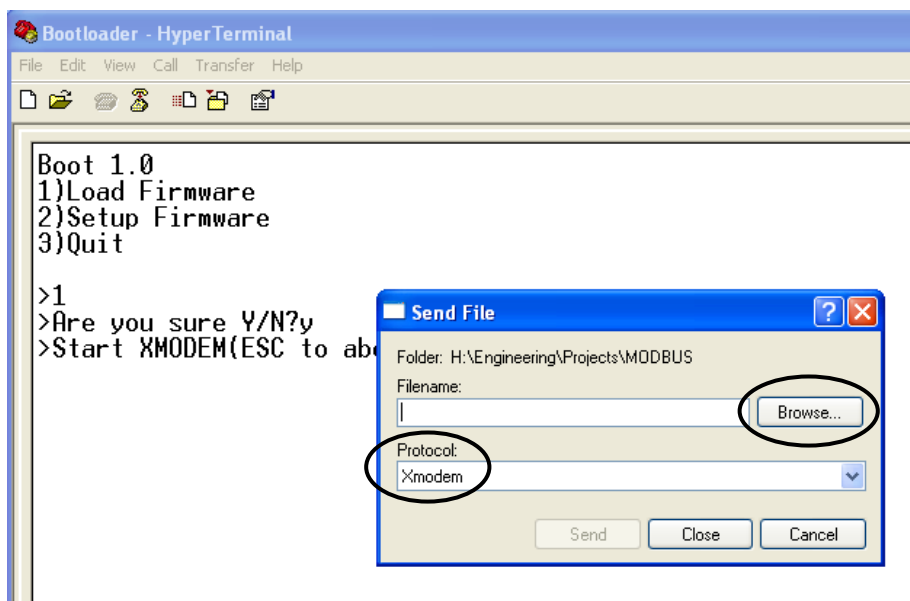

- Click the “Browse” button to select the file to download to your device. Note: Only files with the “.hex” extension can be downloaded to the unit.
- Under the “Protocol” field, select “Xmodem.”
- Click on the “Send” button to start the transfer of the file. A transfer screen will pop up showing the status of the transfer.

If you need to stop or cancel the download, press the “Cancel” icon or press the “ESC” key on your keyboard to return to the bootloader menu. . However early termination of the download can corrupt the firmware already loaded.

	<p>Warning!</p> <p>Once the download has started, you should not stop it. Stopping the download will result in corruption the current application.</p>
---	---

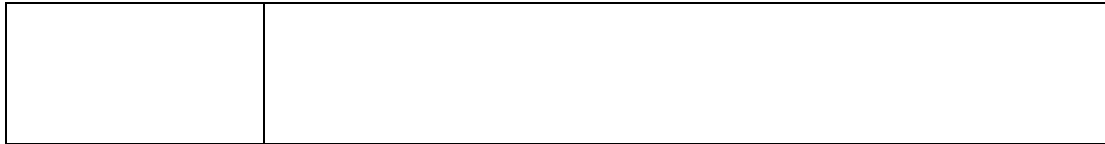

The download is now in progress:

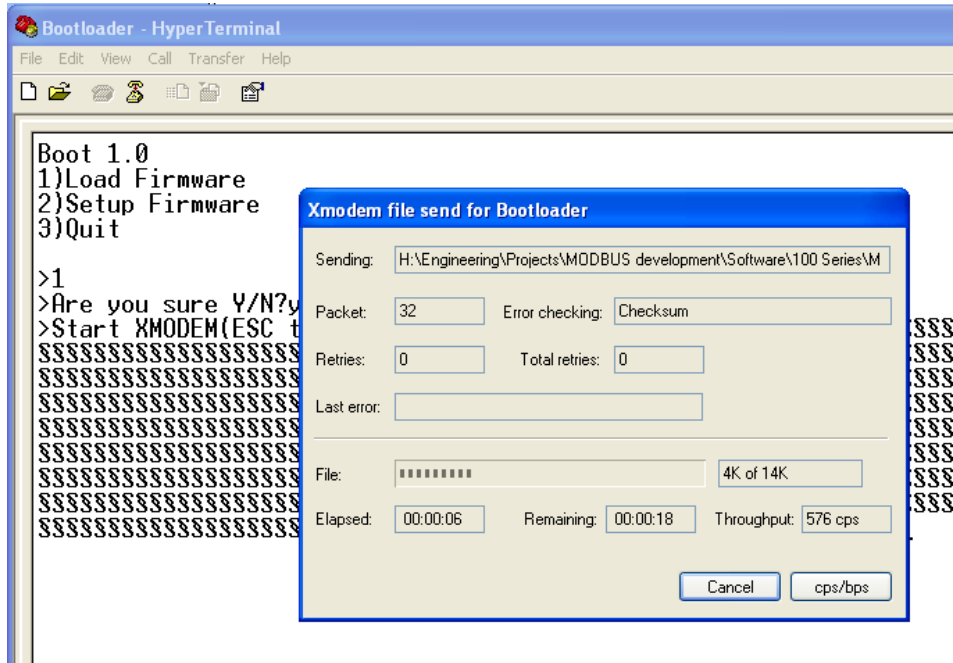

10. When the download is finished, the start-up menu screen will be appear again presenting three the original three options: 1) Load Firmware, 2) Setup Firmware, and 3) Quit.

Setup Firmware

The Setup Firmware option is used to set up the firmware in the unit. To setup the firmware click the “2” key, and the following window will appear:

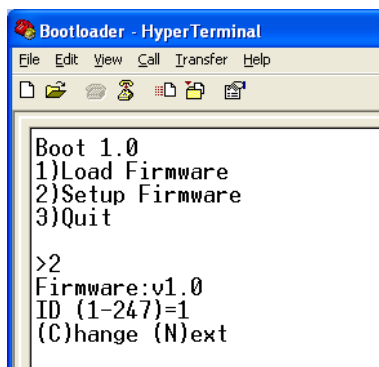

Also, shown on this screen is the version of the firmware, the first option which you can set, the currently selected value ID values, and what values you can select to change. In this above example, the ID code of the unit can be set between 1- 247. The current setting for the ID is 1.

Pressing the “C” key will prompt for a new value. Enter a new value and press the “Enter” key. The new value will be stored, and the next option will be presented (if available). Data which can be entered must match the type presented. So in the above example, only numbers (1, 2, 3, etc.) can be entered.

	<p>Note</p> <p>The amount of character space is limited to the character size of the longest value in the specific category. For example: in the above image, the ID category is limited to 3 character spaces since 247 is the longest value.</p>
---	---

	<p>Warning!</p> <p>It is advised to only enter values which are shown between the brackets on the software. Entering in other values could result in the unit not functioning correctly.</p>
---	---

When all options have been viewed the default bootloader menu will be presented again. The options presented will depend on the firmware. The setup options and defaults are:

Firmware:v7.1
ID (1-247)=1
(C)hange (N)ext
Baudrate (1=4800,2=9600,3=19K2,4=38K4,5=57K6)=3
(C)hange (N)ext
Parity (1=None,2=Odd,3=Even)=3
(C)hange (N)ext
Response delay (ms)=8
(C)hange (N)ext
Tag=Inds-v71
(C)hange (N)ext
FP byte order (0=4321,1=2143,2=1234,3=3412)=3
(C)hange (N)ext

**Note**

While entering a new value the “backspace” key can be used to erase entered values.

Quit

This option will quit the bootloader and start the application.

Troubleshooting

Problem	Solution
During the firmware transfer the download has halted and nothing is happening anymore (or an error message appears)	Reset the unit and try again. Make sure that only .hex files intended for the unit are selected.
When trying to enter data the length is limited. No more data is accepted	For each option the data type and length are predefined. When data isn't accepted anymore than the maximum is reached. Also it's not possible to enter characters when numbers are expected (and vice-versa).
The characters on the screen are all messed up.	Check the communication settings. The settings should be 9600,8,N,1
The unit doesn't enter the bootloader although the enter key is pressed within two seconds after start-up.	Try swapping the “A” & “B” lines of the RS-485 connection and try again.