

FastTrak™ 730

Mass Vortex Flow Meters

Model: 730

Instruction Manual



Part Number: IM-73-FT
Version G.9/18



SIERRA®

Global Support Locations: We are here to help!

For Global Service Centers, go to <http://www.sierrainstruments.com/facilities.html>

CORPORATE HEADQUARTERS

5 Harris Court, Building L Monterey, CA 93940
Phone (831) 373-0200 (800) 866-0200 Fax (831) 373-4402
info@sierrainstruments.com
www.sierrainstruments.com

EUROPE HEADQUARTERS

Bijlmansweid 2 1934RE Egmond aan den Hoef
The Netherlands
Phone +31 72 5071400 Fax +31 72 5071401
sales@sierrainstruments.nl

ASIA HEADQUARTERS

Second Floor Building 5, Senpu Industrial Park
25 Hangdu Road Hangtou Town
Pu Dong New District, Shanghai, P.R. China
Postal Code 201316
Phone: + 8621 5879 8521 Fax: +8621 5879 8586

IMPORTANT CUSTOMER NOTICE- OXYGEN SERVICE

Unless you have specifically ordered Sierra's optional O₂ cleaning, this flow meter may not be fit for oxygen service. Sierra Instruments, Inc., is not liable for any damage or personal injury, whatsoever, resulting from the use of Sierra Instruments standard mass flow meters for oxygen gas. You are responsible for cleaning the mass flow meter to the degree required for your oxygen flow application. However, some models can only be properly cleaned during the manufacturing process.

© COPYRIGHT SIERRA INSTRUMENTS 2018

No part of this publication may be copied or distributed, transmitted, transcribed, stored in a retrieval system, or translated into any human or computer language, in any form or by any means, electronic, mechanical, manual, or otherwise, or disclosed to third parties without the express written permission of Sierra Instruments. The information contained in this manual is subject to change without notice.

TRADEMARKS



FastTrak™ and FastTrak™ are trademarks of Sierra Instruments, Inc. Other product and company names listed in this manual are trademarks or trade names of their respective manufacturers.

Contents

- Chapter 1 | Introduction..... 7
- Chapter 2 | Installation..... 8
 - Installation Overview 8
 - Unobstructed Flow Requirements 8
 - Installation 9
 - Wiring Connections-NEMA 2 CE Enclosures 10
 - Output Signal Wiring..... 10
 - Troubleshooting the Flow Meter 11
 - Return Equipment to Factory 13
- Appendix A | Product Specifications 14

Warnings In This Manual

“Warning,” “Caution,” and “Note” statements are used throughout this manual to draw your attention to important information.

Symbol Key		
Symbol	Symbol Meaning	Description
	Warning	“Warning” statements appears with information that is important to protect people and equipment from damage. Pay very close attention to all warnings that apply to your application. Failure to comply with these instructions may damage the meter and cause personal injury.
	Caution	“Attention” indicates that failure to comply with stated instructions may result in damage or faulty operation of the meter.
	Note	“Note” indicates that ignoring the relevant requirements or precautions may result in flow meter damage or malfunction.



Warning!

- All wiring procedures must be performed with the power off.



Caution!

- All flow meter connections and fittings must have the same or higher pressure rating as the main pipeline.
- Do not connect power to the 4-20 mA terminals.
- Before attempting any flow meter repair, verify that the line is depressurized.
- Always remove main power before disassembling any part of the flow meter.
- Printed circuit boards are sensitive to electrostatic discharge. To avoid damaging the board, follow these precautions to minimize the risk of damage:

- before handling the assembly, discharge your body by touching a grounded, metal object
- handle all cards by their edges unless otherwise required
- when possible, use grounded electrostatic discharge wrist straps when handling sensitive components

Receipt of System Components

When receiving a Sierra mass flow meter, carefully check the outside packing carton for damage incurred in shipment. If the carton is damaged, notify the local carrier and submit a report to the factory or distributor. Remove the packing slip and check that all ordered components are present. Make sure any spare parts or accessories are not discarded with the packing material. Do not return any equipment to the factory without first contacting Sierra Customer Service.

Technical Assistance

If you encounter a problem with your flow meter, review the configuration information for each step of the installation, operation, and setup procedures. Verify that your settings and adjustments are consistent with factory recommendations. Installation and troubleshooting information can be found in the Chapter 2 (Installation) and Chapter 4 (Troubleshooting) of this manual.

If the problem persists after following the troubleshooting procedures outlined in Chapter 4 of this manual, contact Sierra Instruments by fax or by e-mail (see inside front cover). For urgent phone support you may call (800) 866-0200 or (831) 373-0200 between 8:00 a.m. and 5:00 p.m. PST. In Europe, contact Sierra Instruments Europe at +31 72 5071400. In the Asia-Pacific region, contact Sierra Instruments Asia at +8621 5879 8521. When contacting Technical Support, make sure to include this information:

- The flow range, serial number, and Sierra order number (all marked on the meter nameplate)
- The software version (visible at start up)
- The problem you are encountering and any corrective action taken
- Application information (gas, pressure, temperature and piping configuration)

Register Your Product Today

Warranty Statement

All Sierra products are warranted to be free from defects in material and workmanship and will be repaired or replaced at no charge to Buyer, provided return or rejection of product is made within a reasonable period but no longer than one (1) year for calibration and non-calibration defects, from date of delivery. To assure warranty service, customers must register their products online on Sierra's website. Online registration of all of your Sierra products is required for our warranty process. Read complete warranty policy at www.sierrainstruments.com/warranty.

Register Warranty Online

Register now at www.sierrainstruments.com/register. Learn more about Sierra's warranty policy at www.sierrainstruments.com/warranty.

Chapter 1 | Introduction

Sierra's Series 730 FastTrak™ Flow Meters provide outstanding measurement accuracy and fast 200 millisecond response time. The meters monitor the mass flow rate of air and process gases in ranges from 0 to 25 scfm (0 to 700 slpm). They are available in pipe sizes from 1/4 inch to 3/4 inches. FastTrak meters are ideal for monitoring flows of non-corrosive gases compatible with the device's wetted materials and applications requiring fast time response.

Sierra's FastTrak sensor is a reference-grade platinum resistance temperature detector (RTD) encapsulated in glass. The platinum RTD wire is wound on a rugged ceramic mandrel for strength and stability. The sensor is located at the tip of a 304 stainless steel probe which is inserted in the gas stream. The sensor consists of two sensing elements—a velocity sensor and a temperature sensor which automatically corrects for changes in gas temperature. When power is applied to the flow meter, the transducer electronics heats the velocity sensor to a constant temperature differential above the gas temperature. The cooling effect of the air as it passes over the heated sensor is measured by the bridge voltage. The meter electronics converts this voltage into a linear 0-5 VDC, 0-10 VDC, or 4-20 mA output signal.

The meter electronics are packaged in an anodized aluminum NEMA enclosure. The electronics are mounted either directly on the sensing probe.

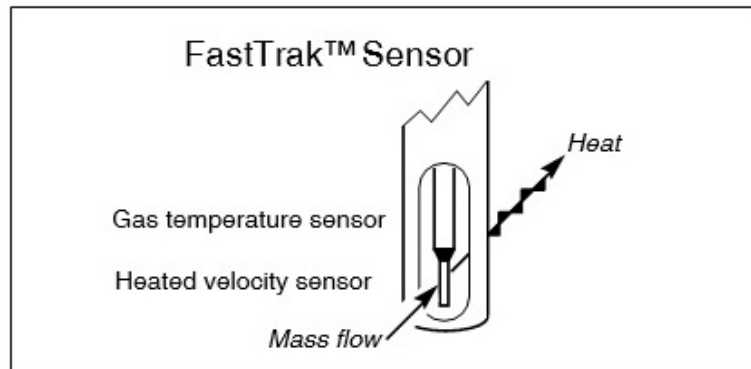

Figure 1. 730 FastTrak Sensor Probe

Chapter 2 | Installation

Installation Overview

When selecting an installation site, make sure that:

1. Line pressure and temperature will not exceed the flow meter rating. Temperature should not vary more than 120°F (50°C) from the calibration temperature. Line pressure should not vary more than 50 psi (3.4 bar) around the calibrated pressure.
2. The ambient temperature falls within the limits of: 32°F (0°C) to 120°F (50°C).
3. The location meets the required minimum number of pipe diameters upstream and downstream of the sensor head (see Figure 2).
4. Safe and convenient access with adequate clearance. Also, verify the meter is located where the gas is clean and dry and the meter is calibrated for the gas to be measured.

Also, before installation check your flow system for anomalies such as:

- leaks
- valves or restrictions in the flow path that could create disturbances in the flow profile that might cause unexpected flow rate indications
- heaters that might cause rapid excursions in the measured temperature

Unobstructed Flow Requirements

Select an installation site that will minimize possible distortion in the flow profile. Valves, elbows, control valves and other piping components may cause flow disturbances. In order to achieve accurate and repeatable performance install the flow meter using the recommended number of straight run pipe diameters upstream and downstream of the sensor given in Figure 2.

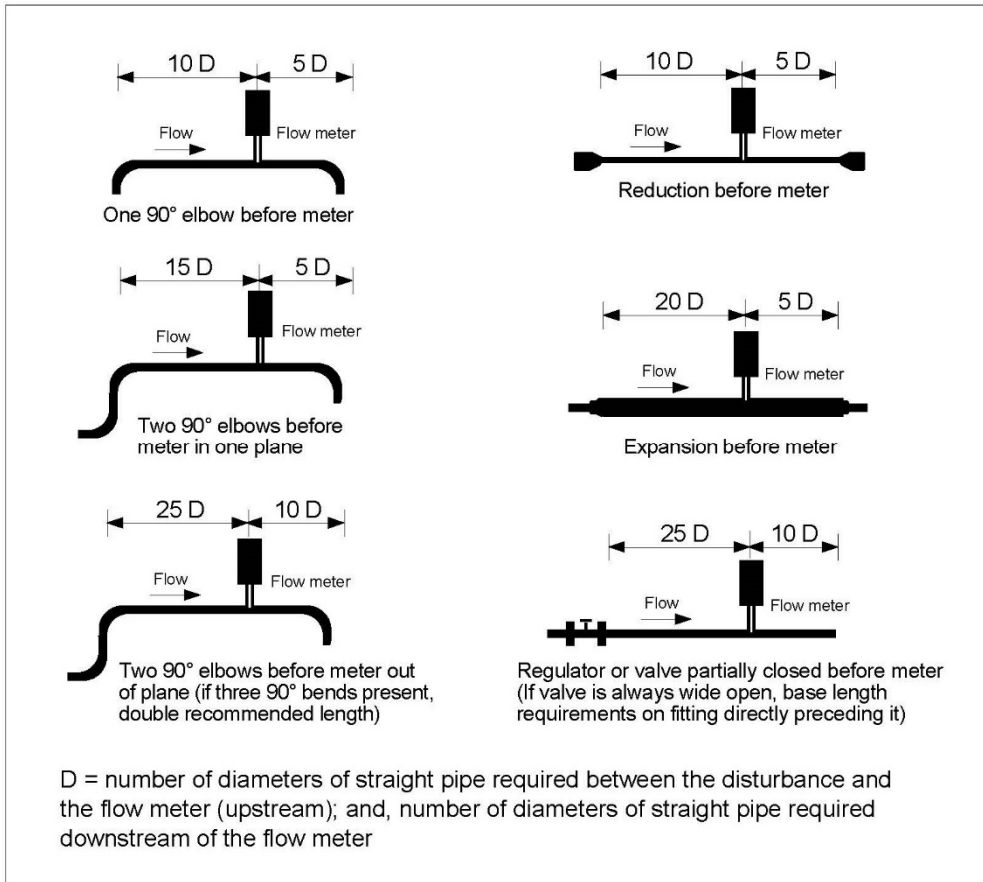



Figure 2. Recommended Pipe Length Requirements for Installation

Installation

The following instructions are general in nature and intended for guideline purposes only.

	<p>Caution! All flow meter connections and fittings must have the same or higher pressure rating as the main pipeline.</p>
---	---

1. Turn off the flow of process gas. Verify that the line is not pressurized.
2. Confirm that the installation site meets the minimum upstream and downstream piping requirements.
3. Position the meter with the flow direction arrow pointing downstream in the direction of flow.
4. Tighten fittings until leak tight (refer to published standards for specific recommendation).
5. Check the system's entire flow path thoroughly for leaks.

Wiring Connections-NEMA 2 CE Enclosures

NEMA 2 enclosures are supplied with a 6-pin connector for direct connection to the supplied mating connector. The pin designations are given in Figure 3 below. Connect 15 VDC input power (300 mA load, maximum) to pin 1 and power ground to pin 5. See “Output Sig nal Wiring” for signal wiring instructions.

	Warning! All flow meter connections and fittings must have the same or higher pressure rating as the main pipeline.
---	--

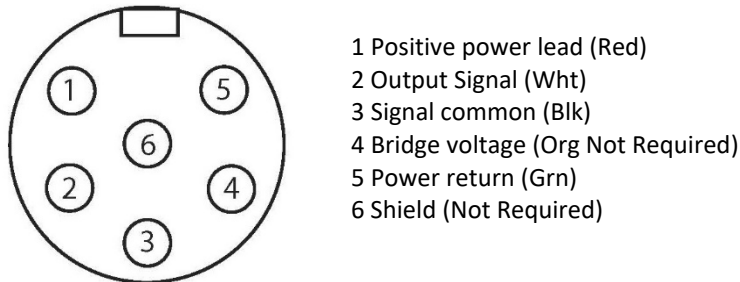

Figure 3. NEMA 2 Enclosure Wiring Connections

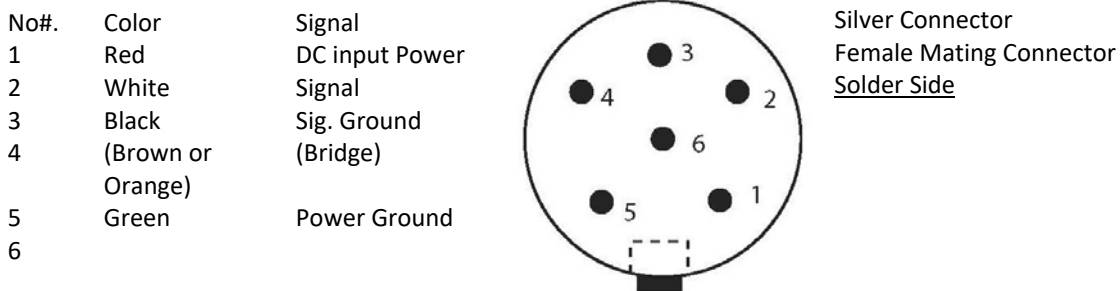



Figure 4. 730 Wiring Connections

Output Signal Wiring

All flow meters are equipped with either a calibrated 0–5 VDC, 0–10 VDC or 4–20 mA output signal. These linear output signals represent 0 to 100% of the flow meter user full scale.

	Caution! Do not connect power to the 4-20 mA terminals.
---	--

DC Output Wiring

The 0-5 VDC or 0-10 VDC output signal can drive a minimum load of 1000 Ohms. For 0-5 VDC or 0-10 VDC connections, connect to the terminals marked Output signal and Signal ground.



4–20 mA Output Wiring

The 4-20 mA current loop output is self-powered (non-isolated).

The maximum loop resistance (load) for the output is 400 Ohms. For a 4–20 mA connection, connect to the terminals marked Output signal and Signal ground.

Troubleshooting the Flow Meter

Begin hardware troubleshooting by verifying the following facilities issues are correct. These areas impact system operation and must be corrected prior to performing any flow meter inspections.

	Caution! Before attempting any flow meter repair, verify that the line is not pressurized.
	Caution! Always remove main power before disassembling any part of the mass flow meter.

1. Verify the incoming power to the flow meter is present and of the correct voltage and polarity.
2. Check the flow meter wiring for correct connections.
3. Verify the flow meter is installed with the correct number of upstream and downstream pipe diameters as shown in Figure 2.
4. Verify the flow direction indicator is correctly aligned pointing downstream of flow.
5. Make sure there are no leaks in the line being measured.

After verifying the factors above, follow the troubleshooting procedures outlined on the next page. If you need to return the flow meter to the factory, see page 10 for return shipping instructions.

Flow Meter Calibration

Sierra Instruments maintains a fully-equipped calibration laboratory. All measuring and test equipment used in the calibration of Sierra meters are traceable to NIST standards. Sierra is ISO-9001 registered and conforms to the requirements of ISO 17025. If the flow body or electronics have been damaged or you simply want to have the flow meter recalibrated, contact the factory for return shipping instructions. Calibration must be performed by qualified personnel using NIST-traceable equipment.

Problem	Possible Cause	Solution
Flow measurement is erratic or fluctuating	Flow meter installed with less than required minimum pipe diameters upstream and downstream of the sensor	Follow installation requirements shown in Figure 2
	Probe is not secured to a solid base	Secure probe to a non-vibrating solid mount
	Sensor component broken	Return to factory for replacement
	Malfunction in system electronics	Malfunction in system electronics
	Moisture present in gas flow	Install a water trap or filter upstream of the flow sensor
Velocity measurement seems too high or low	Sensor assembly not aligned correctly to flow	Correct alignment with the flow indicator pointing downstream in the direction of flow
No response to flow from sensor assembly	No power	Turn on power to the flow meter
	Flow profile distortions	Try to find another location for the meter
	Extremely turbulent flow	Do not place the meter near a ventilator, static mixer or valve
	Sensor failure	Return to factory for repair
	Malfunction in system electronics	Return to factory for evaluation
System will not zero	Out of calibration	Return to factory for
	Probe tip is broken	Return to factory for repair
4-20 mA output circuit not indicating 4 mA at zero flow	Improper current loop resistance; total current loop resistance must be no less than 150 Ohms and no greater than 450 Ohms	Install load resistor or use larger gauge wire
Output pegs plus or minus	Flow body not plugged in	Plug in both connectors
	Malfunction in system electronics	Return to factory for evaluation

Return Equipment to Factory

Factory Calibration—All Models

Sierra Instruments maintains a fully-equipped calibration laboratory. All measuring and test equipment used in the calibration of Sierra transducers are traceable to NIST Standards. Sierra is ISO-9001 registered and conforms to the requirements of ANSI/NCSL-Z540 and ISO/IEC Guide 25.

Instructions for Returning Your Instrument for Service

The following information will help you return your instrument to Sierra Instruments' Factory Service Center and will ensure that your order is processed promptly. Prices may vary depending on the flow range, type of gas and operating pressure of your unit. To request detailed pricing, contact your local Sierra Instruments distributor or contact one of our offices directly.

Please follow these easy steps to return your instrument for factory service:

1. To obtain a Return Materials Authorization (RMA) go to:
www.sierrainstruments.com/rma/new.php to create a Sierra Account.
2. Once you have created an account, click on the Submit New RMA tab and fill in the RMA form and follow the instructions. You will receive an email confirmation once you have submitted your RMA.
3. Print a copy of the RMA (that now includes RMA #) and send a copy of the RMA form along with your meter back to the factory.

If you require service beyond calibration, but do not know which service(s) will be required, describe the symptoms as accurately as possible on the RMA form.

Pack your instrument carefully. Use the original packaging and foam or bubble wrap (packing peanuts NOT recommended) and include a copy of the RMA form (complete with Sierra supplied RMA number) with the unit(s).

Ship the unit(s) to the following address:

Sierra Instruments, Inc.
Attention: Factory Service Center
5 Harris Court, Building L
Monterey, CA 93940 USA
RE: RMA# (your number)

For Global Service Centers, go to <http://www.sierrainstruments.com/facilities.html>

Appendix A | Product Specifications

SPECIFICATIONS

PERFORMANCE SPECIFICATIONS

Accuracy

+/- 1.0% of full scale over 32° to 120°F (0° to 50°C) and 5 to 30 psia (0.3 to 2 barg)

Repeatability

+/- 0.2% of full scale

Temperature Coefficient

+/- 0.02% of reading per °F within +/- 50°F (25°C) of customer specified conditions
 +/- 0.03% of reading per °F within +/- 50° to 100°F (25°C to 50°C) of customer specified conditions

Pressure Coefficient

0.02% per psi for air, consult factory for other gases

Response Time

200 milliseconds to 63% of final velocity value

OPERATING SPECIFICATION

Gases

Most non-combustible, non-corrosive gases including Air, Argon, CO₂ Helium and Nitrogen

Gas Pressure

Maximum 120 psig (8 barg)

Mass Flow Rate

Standard flow rates shown below. Lower and higher flow rates are available upon request. Ranges change with other gases (contact factory).

NPT Size	Mass Flow Rate For Air			
	Flow Range (scfm)		Flow Range (slpm)	
	Minimum	Maximum	Minimum	Maximum
1/4 inch	0 to 0.02	0 to 7	0 to 0.5	0 to 200
1/2 inch	0 to 1	0 to 12	0 to 34	0 to 340
3/4 inch	0 to 2.5	0 to 25	0 to 70	0 to 700

Pressure Drop

Negligible

Gas & Ambient Temperature

Gas 15° to 176°F (-10° to 80°C)

Ambient 32° to 120°F (0° to 50°C)

Leak Integrity

1 X 10⁻⁴ atm cc/sec of helium maximum

Power Requirements

15 to 18 VDC, 300 mA

Output Signal (choice of one)

Linear 0 to 5 VDC proportional to mass flow rate,
 1000 ohms minimum load resistance

Linear 4 to 20 mA proportional to mass flow rate,
 400 ohms maximum loop resistance

All dimensions are inches. Millimeters are in parentheses. Certified drawings are available on request.

1/4 to 3/4-Inch NPT - Front View

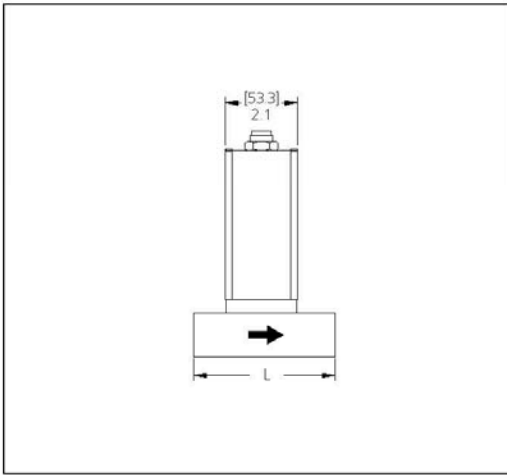

1/4 to 3/4-Inch NPT - Outlet View

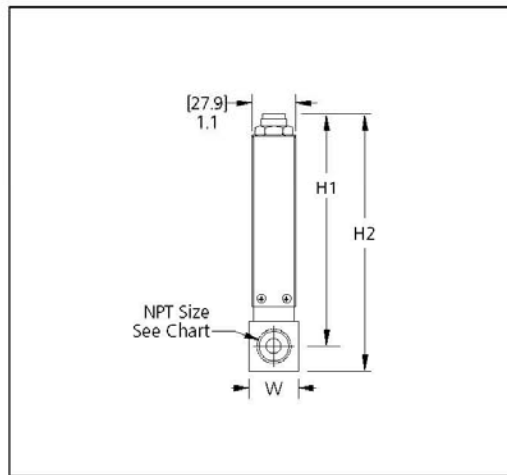

Model 730 Dimensions				
NPT Size	L	H1	H2	W
1/4-inch (Female)	3.1 (79)	5.8 (147)	6.4 (163)	1.2 (163)
1/2-inch (Female)	4.0 (102)	5.8 (147)	6.4 (163)	1.2 (163)
3/4-inch (Female)	4.0 (102)	5.8 (147)	6.4 (163)	1.2 (163)

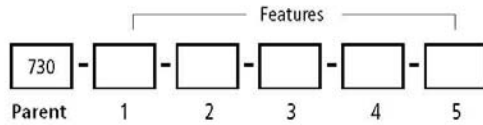

Instructions: To order a 730 please fill in each number block by selecting the codes from the corresponding features below.

Parent Number	
730	FastTrak [®] In-line Mass Flow Meter. 15 -18 VDC input power; linear 0-5 VDC or 4-20 mA output; 200 msec response; Calibrated temperatures up to 176°F (80°C) and pressures up to 120 psig (8 barg).

Feature 1: Body Size	
N1-1	1/4-inch Female NPT-Anodized Aluminum
N2-1	1/2-inch Female NPT-Anodized Aluminum
N3-1	3/4-inch Female NPT-Anodized Aluminum
N1-2	1/4-inch Female NPT-316SS
N2-2	1/2-inch Female NPT-316SS
N3-2	3/4-inch Female NPT-316SS

Feature 2: Electronics Enclosure	
EO	NEMA 2 Enclosure. Mounted directly on the body

Feature 3: Input Power	
PV1	15-18 VDC
PV-2	24 VDC

Feature 4: Output	
V1	0-5 VDC, Linear
V3	0-10 VDC, linear
V4	4-20 mA, Linear

Feature 5: Gas	
0	Air
1	Argon
2	Carbon dioxide
6	Helium
10	Nitrogen
99	Other-Consult Factory

Note: Consult Page 3.



Sierra Instruments, North America • 5 Harris Court, Building L • Monterey, California 93940 • (800) 866-0200 • (831) 373-0200 • Fax (831) 373-4402 • www.sierrainstruments.com
 Sierra Instruments, Europe • Bijlmansweid 2 • 1934RE Egmond aan den Hoef • The Netherlands • +31 72 5071400 • Fax: +31 72 5071401
 Sierra Instruments, Asia • Second Floor Building 5 • Senpu Industrial Park • 25 Hangdu Road Hangtoun Town • Pu Dong New District • Shanghai, P.R. China 201316 • +8621 5879 8521/22 • Fax: +8621 5879 8586
 730 D.9/11