

**Sierra Series 240 and 241
Innova-Mass™ Multi-Parameter
Vortex Mass Flow Meters
Models 240-VT, 240-VTP, 241-VT, 241-VTP**

Instruction Manual

Part Number IM-24X, Rev. A 1/07

IMPORTANT: *This manual is for use with 240/241 Vortex Products
purchased February 2007 or later*



5 Harris Court, Building L, Monterey, CA 93940
(831) 373-0200 (800) 866-0200 Fax: (831) 373-4402
<http://www.sierrainstruments.com>

Sierra Instruments b.v. Bolstoen 30A 1046 AV Amsterdam The Netherlands
+31(0) 20-6145810 Fax +31 (0) 20-6145815

Customer Notice

Unless you have specifically ordered Sierra's optional O₂ cleaning, this flow meter may not be fit for oxygen service. Sierra Instruments, LLC., is not liable for any damage or personal injury, whatsoever, resulting from the use of Sierra Instruments standard mass flow meters for oxygen gas. You are responsible for cleaning the mass flow meter to the degree required for your oxygen flow application.

© COPYRIGHT SIERRA INSTRUMENTS 1997

No part of this publication may be copied or distributed, transmitted, transcribed, stored in a retrieval system, or translated into any human or computer language, in any form or by any means, electronic, mechanical, manual, or otherwise, or disclosed to third parties without the express written permission of Sierra Instruments. The information contained in this manual is subject to change without notice.

TRADEMARKS

Innova-Mass™ is a trademark of Sierra Instruments, Inc. Other product and company names listed in this manual are trademarks or trade names of their respective manufacturers.

Table of Contents

Chapter 1 Introduction

Innova-Mass™ Vortex Mass Flow Meters	1-1
Using this Manual	1-1
Note and Safety Information	1-2
Receipt of System Components	1-2
Technical Assistance	1-2
How the Innova-Mass Vortex Meter Operates	1-3
Velocity Measurement/Pressure Drop.....	1-3
Temperature Measurement.....	1-6
Pressure Measurement.....	1-7
Flow Meter Configurations.....	1-7

Chapter 2 Installation

Installation Overview.....	2-1
Flow Meter Installation Requirements	2-1
Unobstructed Flow Requirements	2-2
Series 240 In-Line Flow Meter Installation.....	2-3
Wafer-Style Flow Meter Installation.....	2-4
Flange-Style Flow Meter Installation.....	2-5
Series 241 Insertion Flow Meter Installation.....	2-6
Cold Tap Guidelines.....	2-7
Hot Tap Guidelines	2-8
Flow Meter Insertion	2-9
Installing Meters with a Compression Connection	2-10
Installing Meters with a Packing Gland Connection.....	2-12
Installing Meters (Packing Gland), No Insertion Tool.....	2-15
Adjusting Meter Orientation.....	2-17
Display/Keypad Adjustment	2-17
Enclosure Adjustment	2-18
Wiring Connections	2-19
Input Power Connections	2-19
4-20 mA Output Connections	2-20
Pulse Output Connections	2-21
Alarm Output Connections.....	2-22
Remote Electronics Wiring	2-23

Chapter 3 Operating Instructions

Flow Meter Display/Keypad.....	3-1
Start Up.....	3-2
Using the Setup Menus	3-3
Programming the Flow Meter	3-3
Output Menu	3-4
Display Menu	3-5
Alarms Menu.....	3-6
Totalizer Menu	3-7

Fluid Menu	3-8
Units Menu	3-9
Time and Date Menu	3-10
Diagnostics Menu	3-11
Calibration Menu	3-12
Password Menu	3-13

Chapter 4 Troubleshooting and Repair

Hidden Diagnostics Menus	4-1
Column One Hidden Diagnostics Values	4-2
Column Two Hidden Diagnostics Values	4-3
Analog Output Calibration	4-4
Troubleshooting the Flow Meter	4-4
Symptom: Output at no Flow	4-4
Symptom: Erratic Output	4-4
Symptom: No Output	4-5
Symptom: Meter Displays Temperature Fault	4-6
Symptom: Meter Displays Pressure Fault	4-6
Electronics Assembly Replacement	4-7
Pressure Sensor Replacement (Series 240 Only)	4-7
Returning Equipment to the Factory	4-8

Appendix A Product Specifications

Appendix B Glossary

Appendix C Fluid Calculations

Appendix D HART Communication

Figures

1-1.	In-Line Vortex Multi-Parameter Mass Flow Meter.....	1-3
1-2.	Measurement Principle of Vortex Flow Meters.....	1-4
1-3.	Reynolds Number Range of the Innova-Mass.....	1-6
2-1.	Recommended Pipe Length Required for Installation.....	2-2
2-2.	Flange Bolt Torquing Sequence	2-3
2-3.	Wafer-Style Flow Meter Installation	2-4
2-4.	Flange-Style Flow Meter Installation	2-5
2-5.	Hot Tap Sequence.....	2-8
2-6.	Insertion Calculation (Compression Type).....	2-10
2-7.	Flow Meter with Compression Type Fitting.....	2-11
2-8.	Insertion Calculation (Meters with Insertion Tool)	2-12
2-9.	Flow Meter with Permanent Insertion Tool.....	2-13
2-10.	Flow Meter with Removable Insertion Tool.....	2-14
2-11.	Insertion Calculation (Meters without Insertion Tool)	2-15
2-12.	Display/Keypad Viewing Adjustment	2-17
2-13.	Enclosure Viewing Adjustment	2-18
2-14.	AC Power Connections.....	2-19
2-15.	DC Power Connections.....	2-19
2-16.	Load Resistance Versus Input Voltage	2-20
2-17.	Isolated 4-20 Output with External Power Supply	2-20
2-18.	Non-Isolated 4-20 Output using Input Power Supply	2-21
2-19.	Isolated Pulse Output with External Power Supply.....	2-21
2-20.	Non-Isolated Pulse Output using Input Power Supply	2-21
2-21.	Isolated Alarm Output with External Power Supply	2-22
2-22.	Non-Isolated Alarm Output using Input Power Supply.....	2-22
2-23.	Junction Box Sensor Connections	2-23
3-1.	Flow Meter Display/Keypad.....	3-1

Tables

2-1.	Minimum Recommended Stud Bolt Lengths	2-3
------	---	-----

Warnings and Cautions



Warning!

Agency approval for hazardous location installations varies between flow meter models. Consult the flow meter nameplate for specific flow meter approvals before any hazardous location installation.

Hot tapping must be performed by a trained professional. U.S. regulations often require a hot tap permit. The manufacturer of the hot tap equipment and/or the contractor performing the hot tap is responsible for providing proof of such a permit.

All flow meter connections, isolation valves and fittings for cold/hot tapping must have the same or higher pressure rating as the main pipeline.

For Series 241 insertion flow meter installations, an insertion tool must be used for any installation where a flow meter is inserted under pressure greater than 50 psig.

To avoid serious injury, DO NOT loosen a compression fitting under pressure.

To avoid potential electric shock, follow National Electric Code or your local code when wiring this unit to a power source. Failure to do so could result in injury or death. All AC power connections must be in accordance with published CE directives. All wiring procedures must be performed with the power Off.

Before attempting any flow meter repair, verify that the line is not pressurized. Always remove main power before disassembling any part of the mass flow meter.



Caution!

Calibration must be performed by qualified personnel. Sierra Instruments, Inc., strongly recommends that you return your flow meter to the factory for calibration.

In order to achieve accurate and repeatable performance, the flow meter must be installed with the specified minimum length of straight pipe upstream and downstream of the flow meter's sensor head.

When using toxic or corrosive gases, purge the line with inert gas for a minimum of four hours at full gas flow before installing the flow meter.

For Series 241 insertion flow meter installations, the sensor alignment pointer must point downstream in the direction of flow.

The AC wire insulation temperature rating must meet or exceed 85°C (185°F).

Chapter 1 Introduction

Innova-Mass™ Multi-Parameter Vortex Mass Flow Meters

The Sierra Instruments' Series 240 In-Line and the Series 241 Insertion Innova-Mass™ Vortex Flow Meters provide a reliable solution for process flow measurement. From a single entry point in the pipeline, Innova-Mass meters offer precise measurements of five parameters including mass flow, volumetric flow, temperature, pressure and fluid density. The unique Innova-Mass design reduces fugitive emissions, wiring, start-up time and work-force requirements.

Innova-Mass digital electronics allows reconfiguration for most gases, liquids and steam with generous rangeability. The meter outputs a pulse signal for remote totalization and up to three 4-20 mA analog signals for monitoring your choice of the five process variables. The local keypad/display provides instantaneous flow rate, total flow, temperature, pressure and density in engineering units.

The Sierra Series 240 and 241 Innova-Mass Meters' simple installation combines with an easy-to-use interface that provides quick set up, long term reliability and accurate mass flow measurement over a wide range of flows, pressures and temperatures.

Using This Manual

This manual provides information needed to install and operate both the Series 240 In-Line and Series 241 Insertion Innova-Mass Flow Meters. The four chapters of this manual cover these areas:

- Chapter 1 includes the introduction and product description
- Chapter 2 provides information needed for installation
- Chapter 3 describes system operation and programming
- Chapter 4 covers troubleshooting and repair

The product specifications are found in Appendix A. Appendix B contains a glossary of terms. Appendix C provides reference fluid calculations. Appendix D provides wiring and configuration information for the Energy meter option.

Note and Safety Information

We use note, caution and warning statements throughout this book to draw your attention to important information.



Warning!

This statement appears with information that is important to protect people and equipment from damage. Pay very close attention to all warnings that apply to your application.



Caution!

This statement appears with information that is important for protecting your equipment and performance. Read and follow all cautions that apply to your application.



Note

This statement appears with a short message to alert you to an important detail.

Receipt of System Components

When receiving a Sierra mass flow meter, carefully check the outside packing carton for damage incurred in shipment. If the carton is damaged, notify the local carrier and submit a report to the factory or distributor. Remove the packing slip and check that all ordered components are present. Make sure any spare parts or accessories are not discarded with the packing material. Do not return any equipment to the factory without first contacting Sierra Customer Service.

Technical Assistance

If you encounter a problem with your flow meter, review the configuration information for each step of the installation, operation and set up procedures. Verify that your settings and adjustments are consistent with factory recommendations. Refer to Chapter 4, Troubleshooting, for specific information and recommendations.

If the problem persists after following the troubleshooting procedures outlined in Chapter 4, contact Sierra Instruments, Technical Support at (888) 386-7835 or (303) 682-9999 between 8:00 a.m. and 5:00 p.m. MST. When calling Technical Support, have the following information on hand:

- the flow range, serial number and Sierra order number (all marked on the meter nameplate)
- the problem you are encountering and any corrective action taken
- application information (gas, pressure, temperature and piping configuration)

How the Innova-Mass Vortex Mass Flow Meter Operates

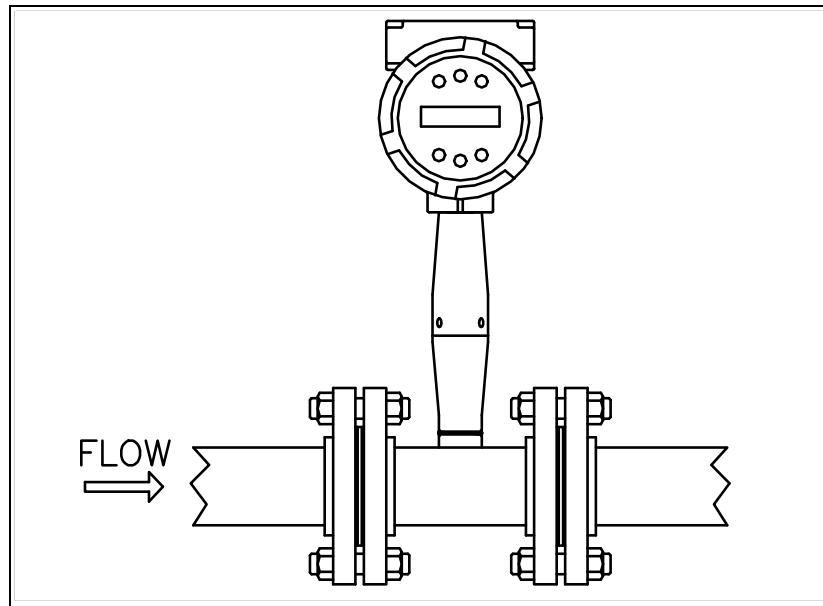

Figure 1-1. In-Line Vortex Multi-Parameter Mass Flow Meter

Sierra Series 240 and 241 Innova-Mass™ Multi-Parameter Vortex Mass Flow Meters use a unique sensor head to monitor mass flow rate by directly measuring three variables—fluid velocity, temperature and pressure. The built-in flow computer calculates the mass flow rate and volumetric flow rate based on these three direct measurements. The velocity, temperature and pressure sensing head is built into the vortex meter's flow body. To measure fluid velocity, the flow meter incorporates a bluff body (shedder bar) in the flow stream and measures the frequency of vortices created by the shedder bar. Temperature is measured using a platinum resistance temperature detector (PRTD). Pressure measurement is achieved using a solid-state pressure transducer. All three elements are combined into an integrated sensor head assembly located downstream of the shedder bar within the flow body.

Velocity Measurement

The Innova-Mass vortex velocity sensor is a patented mechanical design that minimizes the effects of pipeline vibration and pump noise, both of which are common error sources in flow measurement with vortex flow meters. The velocity measurement is based on the well-known Von Karman vortex shedding phenomenon. Vortices are shed from a shedder bar, and the vortex velocity sensor located downstream of the shedder bar senses the passage of these vortices. This method of velocity measurement has many advantages including inherent linearity, high turndown, reliability and simplicity.

Vortex Shedding Frequency

Von Karman vortices form downstream of a shedder bar into two distinct wakes. The vortices of one wake rotate clockwise while those of the other wake rotate counterclockwise. Vortices generate one at a time, alternating from the left side to the right side of the shedder bar. Vortices interact with their surrounding space by over-powering every other nearby swirl on the verge of development. Close to the shedder bar, the distance (or wave length) between vortices is always constant and measurable. Therefore, the volume encompassed by each vortex remains constant, as shown below. By sensing the number of vortices passing by the velocity sensor, the Innova-Mass™ Flow Meter computes the total fluid volume.

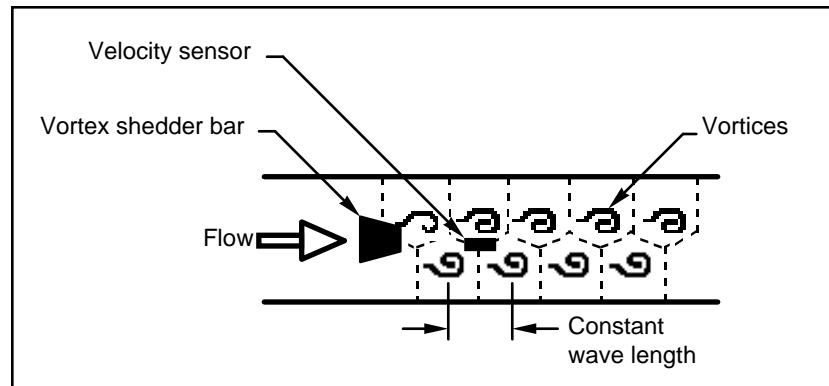

Figure 1-2. Measurement Principle of Vortex Flow Meters

Vortex Frequency Sensing

The velocity sensor incorporates a piezoelectric element that senses the vortex frequency. This element detects the alternating lift forces produced by the Von Karman vortices flowing downstream of the vortex shedder bar. The alternating electric charge generated by the piezoelectric element is processed by the transmitter's electronic circuit to obtain the vortex shedding frequency. The piezoelectric element is highly sensitive and operates over a wide range of flows, pressures and temperatures.

Flow Velocity Range

To ensure trouble-free operation, vortex flow meters must be correctly sized so that the flow velocity range through the meter lies within the measurable velocity range (with acceptable pressure drop) and the linear range.

The measurable range is defined by the minimum and maximum velocity using the following table.

	Gas	Liquid	
Vmin	$\sqrt{\frac{25}{\rho}}$ ft/s	1 ft/s	English ρ (lb/ft ³)
Vmax	300 ft/s	30 ft/s	
Vmin	$\sqrt{\frac{37}{\rho}}$ m/s	0.3 m/s	Metric ρ (kg/m ³)
Vmax	91 m/s	9.1 m/s	

The **pressure drop** for series 241 insertion meters is negligible. The pressure drop for series 240 in-line meters is defined as:

$$\Delta P = .00024 \rho V^2 \quad \text{English units } (\Delta P \text{ in psi, } \rho \text{ in lb/ft}^3, V \text{ in ft/sec})$$

$$\Delta P = .000011 \rho V^2 \quad \text{Metric units } (\Delta P \text{ in bar, } \rho \text{ in kg/m}^3, V \text{ in m/sec})$$

The linear range is defined by the Reynolds number. The Reynolds number is the ratio of the inertial forces to the viscous forces in a flowing fluid and is defined as:

$$Re = \frac{\rho V D}{\mu}$$

Where

Re = Reynolds Number

ρ = mass density of the fluid being measured

V = velocity of the fluid being measured

D = internal diameter of the flow channel

μ = viscosity of the fluid being measured

The Strouhal number is the other dimensionless number that quantifies the vortex phenomenon. The Strouhal number is defined as:

$$St = \frac{f d}{V}$$

Where

St = Strouhal Number

f = frequency of vortex shedding

d = shedder bar width

V = fluid velocity

As shown in Figure 1-3, Innova-Mass™ meters exhibit a constant Strouhal number across a large range of Reynolds numbers, indicating a consistent linear output over a wide range of flows and fluid types. Below this linear range, the intelligent electronics in Innova-Mass automatically corrects for the variation in the Strouhal number with the Reynolds number. The meter's smart electronics corrects for this non-linearity via its simultaneous measurements of the process fluid temperature and pressure. This data is then used to calculate the Reynolds number in real time. Innova-Mass meters automatically correct down to a Reynolds number of 5,000.

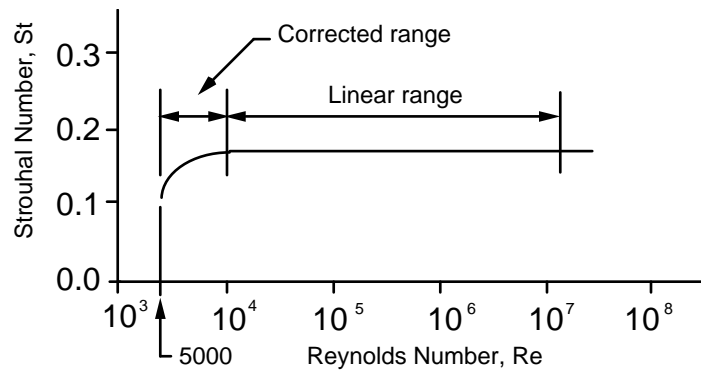

Figure 1-3. Reynolds Number Range for the Innova-Mass

Temperature Measurement

Innova-Mass Flow Meters use a 1000 ohm platinum resistance temperature detector (PRTD) to measure fluid temperature.

Pressure Measurement

Innova-Mass Flow Meters incorporate a solid-state pressure transducer isolated by a 316 stainless steel diaphragm. The transducer itself is micro-machined silicon, fabricated using integrated circuit processing technology. A nine-point pressure/temperature calibration is performed on every sensor. Digital compensation allows these transducers to operate within a 0.3% of full scale accuracy band within the entire ambient temperature range of -4°F to 140°F. Thermal isolation of the pressure transducer ensures the same accuracy across the allowable process fluid temperature range of -40°F to 750°F.

Flow Meter Configurations

Innova-Mass™ Vortex Mass Flow Meters are available in two configurations:

- Series 240 in-line flow meter (replaces a section of the pipeline)
- Series 241 insertion flow meter (requires a “cold” tap or a “hot” tap into an existing pipeline)

Both the in-line and insertion configurations are similar in that they both use identical electronics and have similar sensor heads. Besides installation differences, the main difference between an in-line flow meter and an insertion flow meter is their method of measurement.

For an in-line vortex flow meter, the shedder bar is located across the entire diameter of the flow body. Thus, the entire pipeline flow is included in the vortex formation and measurement. The sensing head, which directly measures velocity, temperature and pressure is located just downstream of the shedder bar.

Insertion vortex flow meters have a shedder bar located across the diameter of a short tube. The velocity, temperature and pressure sensor are located within this tube just downstream of a built-in shedder bar. This entire assembly is called the insertion sensing head. It fits through any entry port with a 1.875 inch minimum internal diameter.

The sensing head of an insertion vortex flow meter directly monitors the velocity at a point in the cross-sectional area of a pipe, duct, or stack (referred to as “channels”). The velocity at a point in the pipe varies as a function of the Reynolds number. The insertion vortex flow meter computes the Reynolds number and then computes the total flow rate in the channel. The output signal of insertion meters is the total flow rate in the channel. The accuracy of the total flow rate computation depends on adherence to the piping installation requirements given in Chapter 2. If adherence to those guidelines cannot be met, contact the factory for specific installation advice.

Flow Meter Electronics

Innova-Mass Flow Meter electronics are available mounted directly to the flow body, or remotely mounted. The electronics housing may be used indoors or outdoors, including wet environments. Power requirements are 100 milliamps at 12-36 VDC. An optional AC powered unit is available. Three analog output signals are available for your choice of three of the five process variables: mass flow rate, volumetric flow rate, temperature, pressure or fluid density.

Innova-Mass Flow Meters include a local 2 x 16 character LCD display housed within the enclosure. Local operation and reconfiguration is accomplished using six pushbuttons operated via finger touch. For hazardous locations, the six buttons can be operated with the electronics enclosure sealed using a hand-held magnet, thereby not compromising the integrity of the hazardous location certification.

The electronics include nonvolatile memory that stores all configuration information. The nonvolatile memory allows the flow meter to function immediately upon power up, or after an interruption in power.

Chapter 2 Installation

Installation Overview

Sierra's Innova-Mass Vortex Flow Meter installations are simple and straightforward. Both the Series 240 In-Line and Series 241 Insertion type flow meter installations are covered in this chapter. After reviewing the installation requirements given below, see page 2-3 for Series 240 installation instructions. See page 2-6 for Series 241 installation instructions. Wiring instructions begin on page 2-19.

Flow Meter Installation Requirements

Before installing the flow meter, verify the installation site allows for these considerations:

1. Line pressure and temperature will not exceed the flow meter rating.
2. The location meets the required minimum number of pipe diameters upstream and downstream of the sensor head as illustrated Figure 2-1.
3. Safe and convenient access with adequate overhead clearance for maintenance purposes.
4. Verify that the cable entry into the instrument meets the specific standard required for hazardous area installations.
5. For remote installations, verify the supplied cable length is sufficient to connect the flow meter sensor to the remote electronics.

Also, before installation check your flow system for anomalies such as:

- leaks
- valves or restrictions in the flow path that could create disturbances in the flow profile that might cause unexpected flow rate indications



Warning!

Consult the flow meter nameplate for specific flow meter approvals before any hazardous location installation.

Unobstructed Flow Requirements

Select an installation site that will minimize possible distortion in the flow profile. Valves, elbows, control valves and other piping components may cause flow disturbances. Check your specific piping condition against the examples shown below. In order to achieve accurate and repeatable performance install the flow meter using the recommended number of straight run pipe diameters upstream and downstream of the sensor.

Note: For liquid applications in vertical pipes, avoid installing with flow in the downward direction because the pipe may not be full at all points. Choose to install the meter with flow in the upward direction if possible.

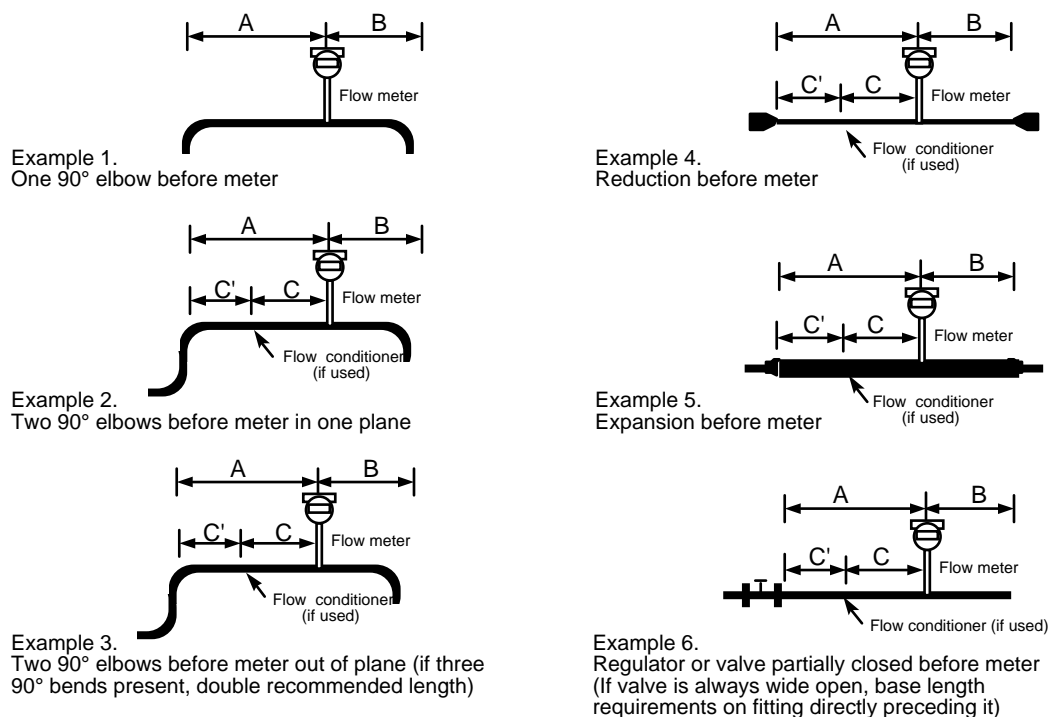

Example	Minimum Required Upstream Diameters				Minimum Required Downstream Diameters	
	No Flow Conditioner	With Flow Conditioner			No Flow Conditioner	With Flow Conditioner
	A	A	C	C'	B	B
1	10 D	N/A	N/A	N/A	5 D	5 D
2	15 D	10 D	5 D	5 D	5 D	5 D
3	25 D	10 D	5 D	5 D	10 D	5 D
4	10 D	10 D	5 D	5 D	5 D	5 D
5	20 D	10 D	5 D	5 D	5 D	5 D
6	25 D	10 D	5 D	5 D	10 D	5 D

D = Internal diameter of channel. N/A = Not applicable

Figure 2-1. Recommended Pipe Length Requirements for Installation, Series 240 and 241

Series 240 In-Line Flow Meter Installation

Install the Series 240 In-Line Flow Meter between two conventional pipe flanges as shown in Figures 2-3 and 2-4. Table 2-1 provides the recommended minimum stud bolt lengths for wafer-style meter body size and different flange ratings.

The meter inside diameter is equal to the same size nominal pipe ID in schedule 80. For example, a 2" meter has an ID of 1.939" (2" schedule 80). **Do not install the meter in a pipe with an inside diameter smaller than the inside diameter of the meter.** For schedule 160 and higher pipe, a special meter is required. Consult the factory before purchasing the meter.

Series 240 Meters require customer-supplied gaskets. When selecting gasket material make sure that it is compatible with the process fluid and pressure ratings of the specific installation. Verify that the inside diameter of the gasket is larger than the inside diameter of the flow meter and adjacent piping. If the gasket material extends into the flow stream, it will disturb the flow and cause inaccurate measurements.

Flange Bolt Specifications

Stud Bolt Lengths for Each Flange Rating (inches)			
Line Size	Class 150	Class 300	Class 600
1 inch	6.00	7.00	7.50
1.5 inch	6.25	8.50	9.00
2 inch	8.50	8.75	9.50
3 inch	9.00	10.00	10.50
4 inch	9.50	10.75	12.25

Table 2-1. Minimum Recommended Stud Bolt Lengths for Wafer Meters

The required bolt load for sealing the gasket joint is affected by several application-dependent factors, therefore the required torque for each application may be different. Refer to the ASME Pressure Vessel Code guidelines for bolt tightening standards.

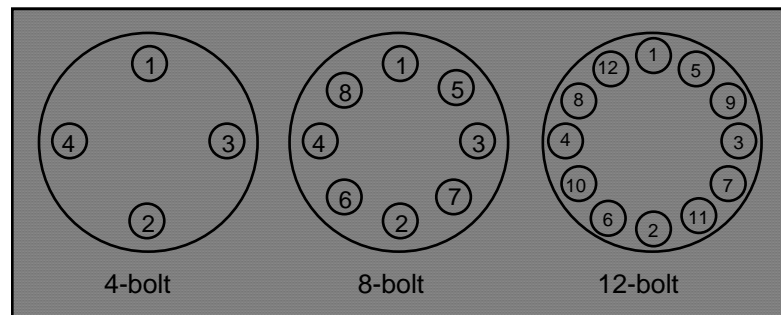

Figure 2-2. Flange Bolt Torquing Sequence

Wafer-Style Flow Meter Installation

Install the wafer-style meter between two conventional pipe flanges of the same nominal size as the flow meter. If the process fluid is a liquid, make sure the meter is located where the pipe is always full. This may require locating the meter at a low point in the piping system. Note: Vortex flow meters are not suitable for two-phase flows (i.e., liquid and gas mixtures). For horizontal pipelines having a process temperature above 300° F, mount the meter at a 45 or 90-degree angle to avoid overheating the electronics enclosure. To adjust the viewing angle of the enclosure or display/keypad, see page 2-17.

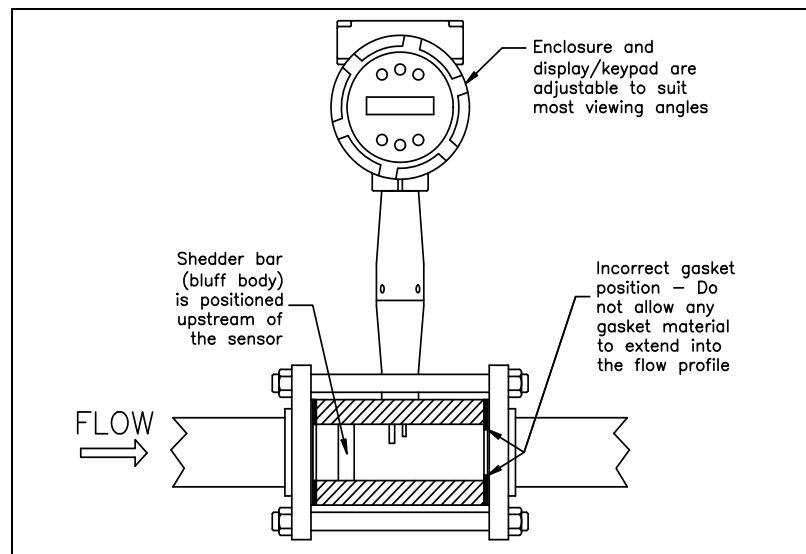

Figure 2-3. Wafer-Style Flow Meter Installation



Caution!

When using toxic or corrosive gases, purge the line with inert gas for a minimum of four hours at full gas flow before installing the flow meter.

When installing the meter make sure the section marked “inlet” is positioned upstream of the outlet, facing the flow. This ensures that the sensor head is positioned downstream of the vortex shedder bar and is correctly aligned to the flow. Installing the meter opposite this direction will result in completely inaccurate flow measurement. To install the meter:

1. Turn off the flow of process gas, liquid or steam. Verify that the line is not pressurized. Confirm that the installation site meets the required minimum upstream and downstream pipe diameters.
2. Insert the studs for the bottom side of the meter body between the pipe flanges. Place the wafer-style meter body between the flanges with the end stamped “inlet” facing flow. Center the meter body inside the diameter with respect to the inside diameter of the adjoining piping.
3. Position the gasket material between the mating surfaces. Make sure both gaskets are smooth and even with no gasket material extending into the flow profile. Obstructions in the pipeline will disturb the flow and cause inaccurate measurements
4. Place the remaining studs between the pipe flanges. Tighten the nuts in the sequence shown in Figure 2-2. Check for leaks after tightening the flange bolts

Flange-Style Flow Meter Installation

Install the flange-style meter between two conventional pipe flanges of the same nominal size as the flow meter. If the process fluid is a liquid, make sure the meter is located where the pipe is always full. This may require locating the meter at a low point in the piping system. Note: Vortex flow meters are not suitable for two-phase flows (i.e., liquid and gas mixtures). For horizontal pipelines having a process temperature above 300° F, mount the meter at a 45 or 90-degree angle to avoid overheating the electronics enclosure. To adjust the viewing angle of the enclosure or display/keypad, see page 2-17.

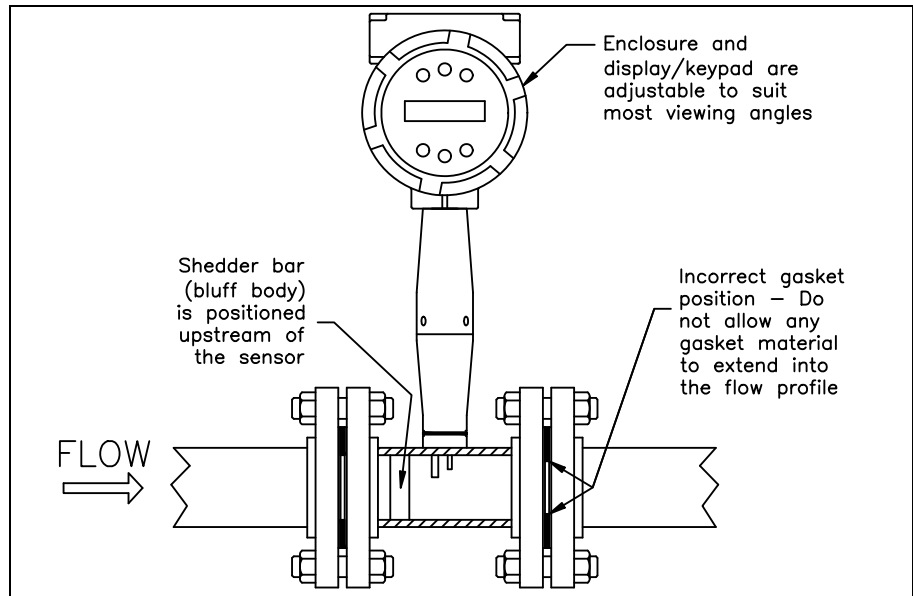

Figure 2-4. Flange-Style Flow Meter Installation



Caution!

When using toxic or corrosive gases, purge the line with inert gas for a minimum of four hours at full gas flow before installing the flow meter.

When installing the meter make sure the flange marked “inlet” is positioned upstream of the outlet flange, facing the flow. This ensures that the sensor head is positioned downstream of the vortex shedder bar and is correctly aligned to the flow. Installing the meter opposite this direction will result in completely inaccurate flow measurement. To install the meter:

1. Turn off the flow of process gas, liquid or steam. Verify that the line is not pressurized. Confirm that the installation site meets the required minimum upstream and downstream pipe diameters.
2. Seat the meter level and square on the mating connections with the flange marked “inlet” facing the flow. Position a gasket in place for each side. Make sure both gaskets are smooth and even with no gasket material extending into the flow profile. Obstructions in the pipeline will disturb the flow and cause inaccurate measurements.
3. Install bolts in both process connections. Tighten the nuts in the sequence shown in Figure 2-2. Check for leaks after tightening the flange bolts.

Series 241 Insertion Flow Meter Installation

Prepare the pipeline for installation using either a cold tap or hot tap method described on the following pages. Refer to a standard code for all pipe tapping operations. The following tapping instructions are general in nature and intended for guideline purposes only. Before installing the meter, review the mounting position and isolation value requirements given below.

Mounting Position

Allow clearance between the electronics enclosure top and any other obstruction when the meter is fully retracted.

Isolation Valve Selection

An isolation valve is available as an option with Series 241 meters. If you supply the isolation valve, it must meet the following requirements:

1. A minimum valve bore diameter of 1.875 inches is required, and the valve's body size should be two inches. Normally, gate valves are used.
2. Verify that the valve's body and flange rating are within the flow meter's maximum operating pressure and temperature.

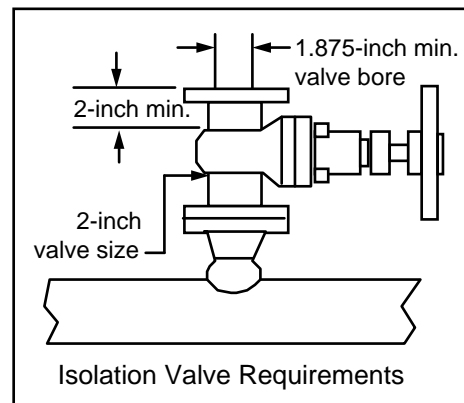

3. Choose an isolation valve with at least two inches existing between the flange face and the gate portion of the valve. This ensures that the flow meter's sensor head will not interfere with the operation of the isolation valve.

Cold Tap Guidelines

Refer to a standard code for all pipe tapping operations. The following tapping instructions are general in nature and intended for guideline purposes only.



Caution!

When using toxic or corrosive gases, purge the line with inert gas for a minimum of four hours at full gas flow before installing the flow meter.



Warning!

All flow meter connections, isolation valves and fittings for cold tapping must have the same or higher pressure rating as the main pipeline.

1. Turn off the flow of process gas, liquid or steam. Verify that the line is not pressurized.
2. Confirm that the installation site meets the minimum upstream and downstream pipe diameter requirements. See Figure 2-1.
3. Use a cutting torch or sharp cutting tool to tap into the pipe. The pipe opening must be at least 1.875 inches in diameter. (Do not attempt to insert the sensor probe through a smaller hole.)
4. Remove all burrs from the tap. Rough edges may cause flow profile distortions that could affect flow meter accuracy. Also, obstructions could damage the sensor assembly when inserting into the pipe.
5. After cutting, measure the thickness of the cut-out and record this number for calculating the insertion depth.

6. Weld the flow meter pipe connection on the pipe. Make sure this connection is within $\pm 5^\circ$ perpendicular to the pipe centerline.

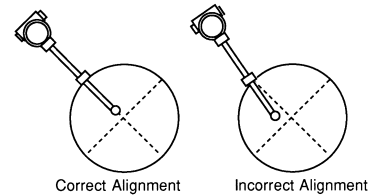

7. Install the isolation valve (if used).
8. When welding is complete and all fittings are installed, close the isolation valve or cap the line. Run a static pressure check on the welds. If pressure loss or leaks are detected, repair the joint and re-test.
9. Connect the meter to the pipe process connection.
10. Calculate the sensor probe insertion depth as described on the following pages. Insert the sensor probe into the pipe.

Hot Tap Guidelines



Warning!

Hot tapping must be performed by a trained professional. US. regulations often require a hot tap permit. The manufacturer of the hot tap equipment and/or the contractor performing the hot tap is responsible for providing proof of such a permit.



Warning!

All flow meter connections, isolation valves and fittings for hot tapping must have the same or higher pressure rating as the main pipeline.

Refer to a standard code for all pipe tapping operations. The following tapping instructions are general in nature and intended for guideline purposes only.

1. Confirm that the installation site meets the minimum upstream and downstream pipe diameter requirements.
2. Weld a two inch mounting adapter on the pipe. Make sure the mounting adapter is within $\pm 5^\circ$ perpendicular to the pipe centerline (see previous page). The pipe opening must be at least 1.875 inches in diameter.
3. Connect a two inch process connection on the mounting adapter.
4. Connect an isolation valve on the process connection. The valve's full open bore must be at least 1.875 inches in diameter.
5. Hot tap the pipe.
6. Close the isolation valve. Run a static pressure check on the welds. If pressure loss or leaks are detected, repair the joint and re-test.
7. Connect the flow meter to the isolation valve.
8. Calculate the sensor probe insertion depth as described on the following pages. Insert the sensor probe assembly into the pipe.

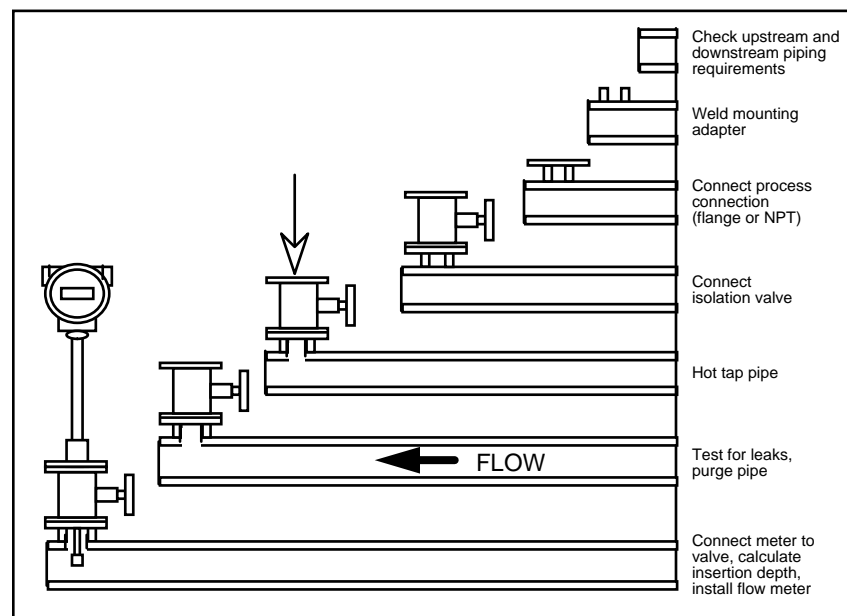

Figure 2-5. Hot Tap Sequence

Flow Meter Insertion

The sensor head must be properly positioned in the pipe. For this reason, it is important that insertion length calculations are carefully followed. A sensor probe inserted at the wrong depth in the pipe will result in inaccurate readings.

Insertion flow meters are applicable to pipes 2 inch and larger. For pipe sizes ten inches and smaller, the centerline of the meter's sensing head is located at the pipe's centerline. For pipe sizes larger than ten inches, the centerline of the sensing head is located in the pipe's cross section five inches from the inner wall of the pipe; i.e., its "wetted" depth from the wall to the centerline of the sensing head is five inches.

Insertion flow meters are available in three probe lengths:

Standard Probe configuration is used with most flow meter process connections. The length, S, of the stem is 29.47 inches.

Compact Probe configuration is used with compression fitting process connections. The length, S, of the stem is 13.1 inches.

12-Inch Extended Probe configuration is used with exceptionally lengthy flow meter process connections. The length, S, of the stem is 41.47 inches.

Use the Correct Insertion Formula

Depending on your flow meter's process connection, use the applicable insertion length formula and installation procedure as follows:

- Flow meters with a compression type connection (NPT or flanged) follow the instructions beginning on page 2-10.
- Flow meters with a packing gland type connection (NPT or flanged) configured with an insertion tool, follow the instructions beginning on page 2-12.
- Flow meters with a packing gland type connection (NPT or flanged) without an insertion tool, follow the instructions beginning on page 2-15.



Warning!

An insertion tool must be used for any installation where a flow meter is inserted under pressure greater than 50 psig.

*Installing Flow Meters with a Compression Connection**

Use the following formula to determine insertion length for flow meters (NPT and flanged) with a compression process connection. The installation procedure is given on the next page.

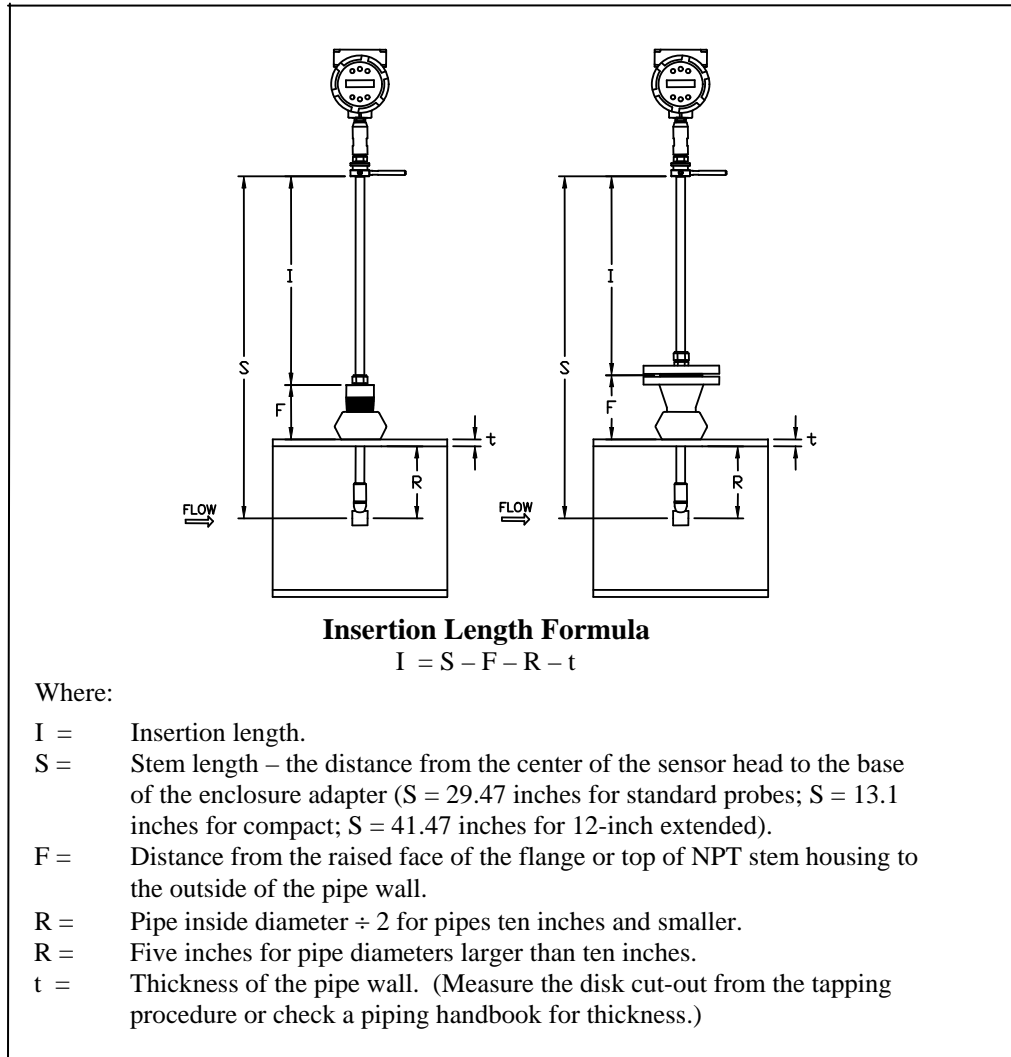

Figure 2-6. Insertion Calculation (Compression Type)

Example:

To install a Series 241 meter with a standard probe (S = 29.47 inches) into a 14 inch schedule 40 pipe, the following measurements are taken:

$$\begin{aligned} F &= 3 \text{ inches} \\ R &= 5 \text{ inches} \\ t &= 0.438 \text{ inches} \end{aligned}$$

The insertion length for this example is 21.03 inches. Insert the stem through the fitting until an insertion length of 21.03 inches is measured with a ruler.

**All dimensions are in inches*

Insertion Procedure for Meters with a Compression Connection

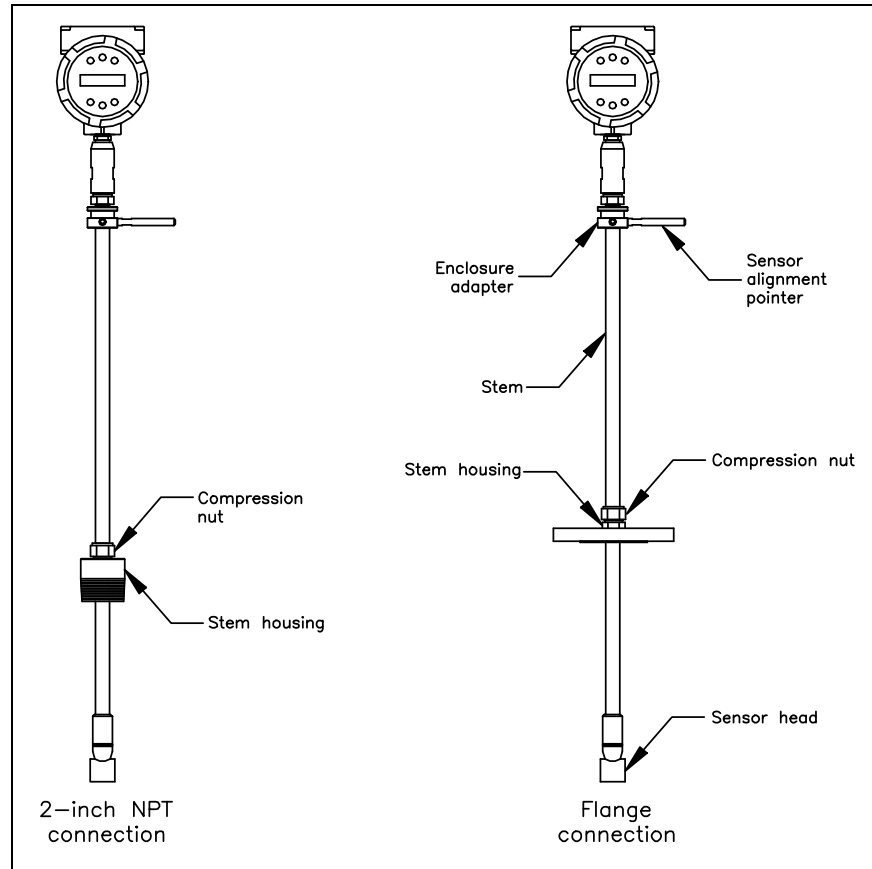

Figure 2-7. Flow Meter with Compression Type Fitting

**Caution!**

The sensor alignment pointer must point downstream, in the direction of flow.

**Warning!**

To avoid serious injury, DO NOT loosen the compression fitting under pressure.

1. Calculate the required sensor probe insertion length.
2. Fully retract the stem until the sensor head is touching the bottom of the stem housing. Slightly tighten the compression nut to prevent slippage.
3. Bolt or screw the flow meter assembly into the process connection. Use Teflon tape or pipe sealant to improve the seal and prevent seizing on NPT styles.
4. Hold the meter securely while loosening the compression fitting. Insert the sensor into the pipe until the calculated insertion length, I , is measured between the base of the enclosure adapter and the top of the stem housing, or to the raised face of the flanged version. Do not force the stem into the pipe.
5. Align the sensor head using the sensor alignment pointer. Adjust the alignment pointer parallel to the pipe and pointing downstream.
6. Tighten the compression fitting to lock the stem in position. **When the compression fitting is tightened, the position is permanent.**

Installing Flow Meters with a Packing Gland Connection*

Use the formula below to determine the insertion depth for flow meters (NPT and flanged) equipped with an insertion tool. To install, see the next page for instructions for meters with a permanent insertion tool. For meters with a removable insertion tool, see page 2-14.

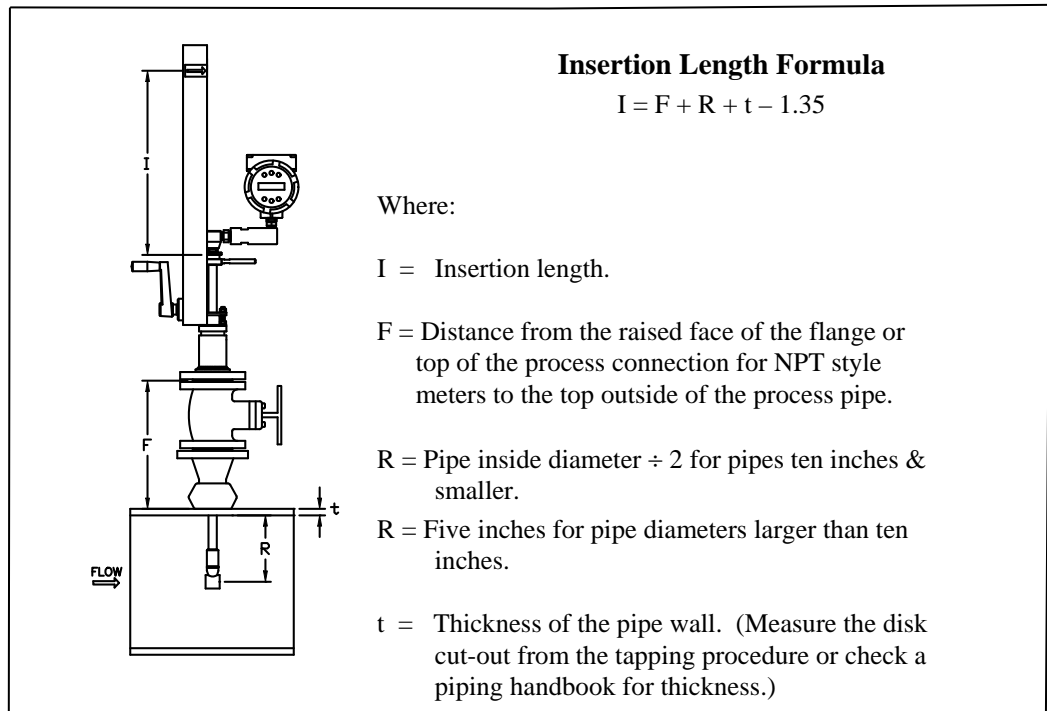

Figure 2-8. Insertion Calculation (Meters with Insertion Tool)

Example 1: Flange Style Meters:

To install a Series 241 Flow Meter into a 14 inch schedule 40 pipe, the following measurements are taken:

$$\begin{aligned} F &= 12 \text{ inches} \\ R &= 5 \text{ inches} \\ t &= 0.438 \text{ inches} \end{aligned}$$

The example insertion length is 16.09 inches.

Example 2: NPT Style Meters:

The length of thread engagement on the NPT style meters is also subtracted in the equation. The length of the threaded portion of the NPT meter is 1.18 inches. Measure the thread portion still showing after the installation and subtract that amount from 1.18 inches. This gives you the thread engagement length. If this cannot be measured use .55 inch for this amount.

$$\begin{aligned} F &= 12 \text{ inches} \\ R &= 5 \text{ inches} \\ t &= 0.438 \text{ inches} \end{aligned}$$

The example insertion length is 15.54 inches.

*All dimensions are in inches.

Insertion Procedure for Flow Meters with Permanent Insertion Tool

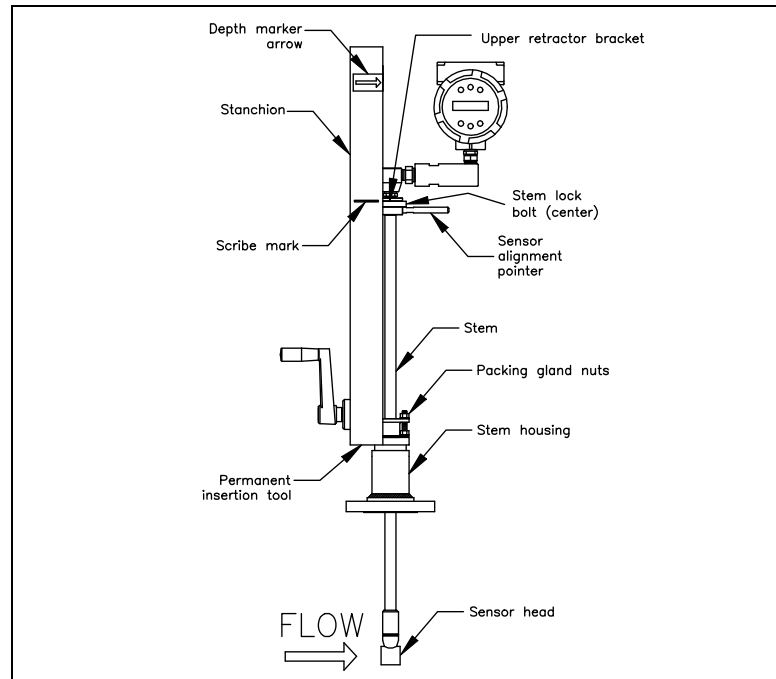

Figure 2-9. Flow Meter with Permanent Insertion Tool



Caution!

The sensor alignment pointer must point downstream, in the direction of flow.



Note

If line pressure is above 500 psig, it could require up to 25 ft lb of torque to insert the flow meter. Do not confuse this with possible interference in the pipe.

1. Calculate the required sensor probe insertion length (see previous page). Measure from the depth marker arrow down the stanchion and scribe a mark at the calculated insertion depth.
2. Fully retract the flow meter until the sensor head is touching the bottom of the stem housing. Attach the meter assembly to the two inch full-port isolation valve, if used. Use Teflon tape or pipe sealant to improve seal and prevent seizing on NPT style.
3. Loosen the two packing gland nuts on the stem housing of the meter. Loosen the stem lock bolt adjacent to the sensor alignment pointer. Align the sensor head using the sensor alignment pointer. Adjust the alignment pointer parallel to the pipe and pointing downstream. Tighten the stem lock bolt to secure the sensor position.
4. Slowly open the isolation valve to the full open position. If necessary, slightly tighten the two packing gland nuts to reduce the leakage around the stem.
5. Turn the insertion tool handle clockwise to insert the sensor head into the pipe. Continue until the top of the upper retractor bracket aligns with the insertion length position scribed on the stanchion. Do not force the stem into the pipe.
6. Tighten the packing gland nuts to stop leakage around the stem. Do not torque over 20 ft-lb.

Insertion Procedure for Flow Meters with Removable Insertion Tool

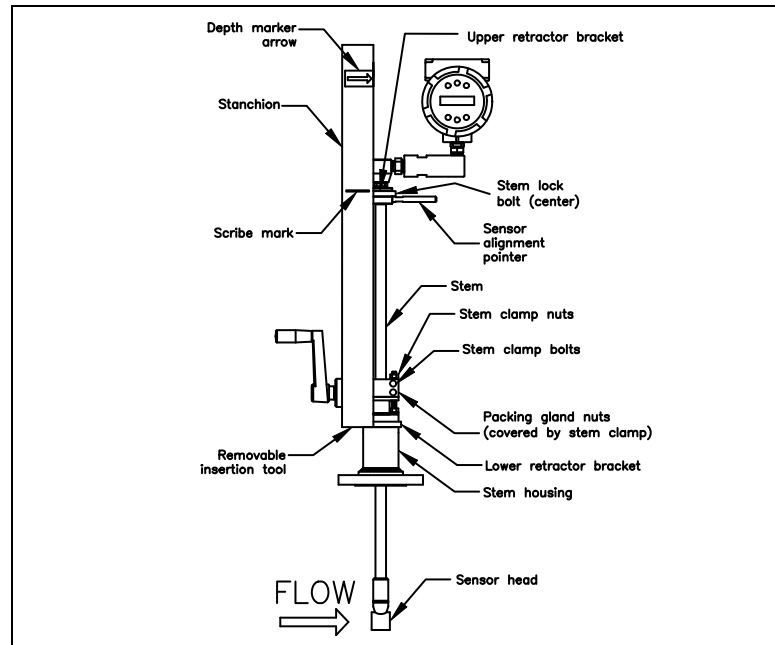

Figure 2-10. Flow Meter with Removable Insertion Tool



Caution!

The sensor alignment pointer must point downstream, in the direction of flow.



Note

If line pressure is above 500 psig, it could require up to 25 ft lb of torque to insert the flow meter. Do not confuse this with possible interference in the pipe.

1. Calculate the required sensor probe insertion length. Measure from the depth marker arrow down the stanchion and scribe a mark at the calculated insertion depth.
2. Fully retract the flow meter until the sensor head is touching the bottom of the stem housing. Attach the meter assembly to the two inch full-port isolation valve, if used. Use Teflon tape or pipe sealant to improve seal and prevent seizing on NPT style.
3. Remove the two top stem clamp nuts and loosen two stem clamp bolts. Slide the stem clamp away to expose the packing gland nuts.
4. Loosen the two packing gland nuts. Loosen the stem lock bolt adjacent to the sensor alignment pointer. Align the sensor head using the sensor alignment pointer. Adjust the alignment pointer parallel to the pipe and pointing downstream. Tighten the stem lock bolt to secure the sensor position.
5. Slowly open the isolation valve to the full open position. If necessary, slightly tighten the two packing gland nuts to reduce the leakage around the stem.
6. Turn the insertion tool handle clockwise to insert the stem into the pipe. Continue until the top of the upper retractor bracket lines up with the insertion length mark scribed on the stanchion. Do not force the stem into the pipe.

7. Tighten the packing gland nuts to stop leakage around the stem. Do not torque over 20 ft-lbs.
8. Slide the stem clamp back into position. Torque stem clamp bolts to 15 ft-lbs. Replace the stem clamp nuts and torque to 10-15 ft-lbs.
9. To separate the insertion tool from the flow meter, remove four socket head cap bolts securing the upper and lower retractor brackets. Remove the insertion tool.

Installation of Meters with Packing Gland Connection (No Insertion Tool)*

Use the following formula to determine insertion depth for meters with a packing gland connection (NPT and flanged) without an insertion tool.

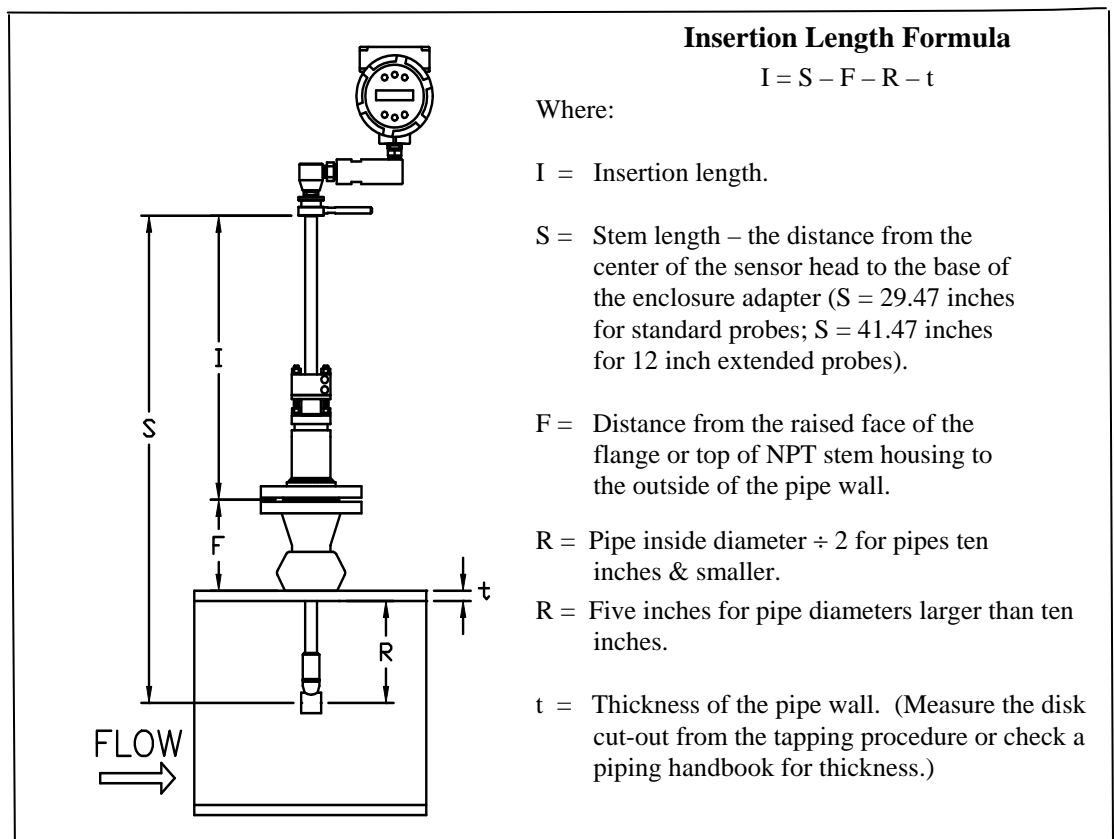

Figure 2-11. Insertion Calculation (Meters without Insertion Tool)

Example:

To install a Series 241 Flow Meter with a standard probe (S = 29.47) into a 14 inch schedule 40 pipe, the following measurements are taken:

$$\begin{aligned} F &= 3 \text{ inches} \\ R &= 5 \text{ inches} \\ t &= 0.438 \text{ inches} \end{aligned}$$

The example insertion length is 21.03 inches.

**All dimensions are in inches.*

Insertion Procedure for Flow Meters with No Insertion Tool (Packing Gland Connection)

**Warning!**

The line pressure must be less than 50 psig for installation.

**Caution!**

The sensor alignment pointer must point downstream, in the direction of flow.

1. Calculate the required sensor probe insertion length.
2. Fully retract the stem until the sensor head is touching the bottom of the stem housing. Remove the two top stem clamp nuts and loosen two stem clamp bolts. Slide the stem clamp away to expose the packing gland nuts. Loosen the two packing gland nuts.
3. Align the sensor head using the sensor alignment pointer. Adjust the alignment pointer parallel to the pipe and pointing downstream.
4. Insert the sensor head into the pipe until insertion length, I , is achieved. Do not force the stem into the pipe.
5. Tighten the packing gland nuts to stop leakage around the stem. Do not torque over 20 ft-lbs.
6. Slide the stem clamp back into position. Torque stem clamp bolts to 15 ft-lbs. Replace the stem clamp nuts and torque to 10-15 ft-lbs.

Adjusting Meter Orientation

Depending on installation requirements, you may need to adjust the meter orientation. There are two adjustments available. The first rotates the position of the LCD display/keypad and is available on both in-line and insertion meters. The second is to rotate the enclosure position. This adjustment is only allowed on Series 240 In-Line meters.

Display/Keypad Adjustment (All Meters)

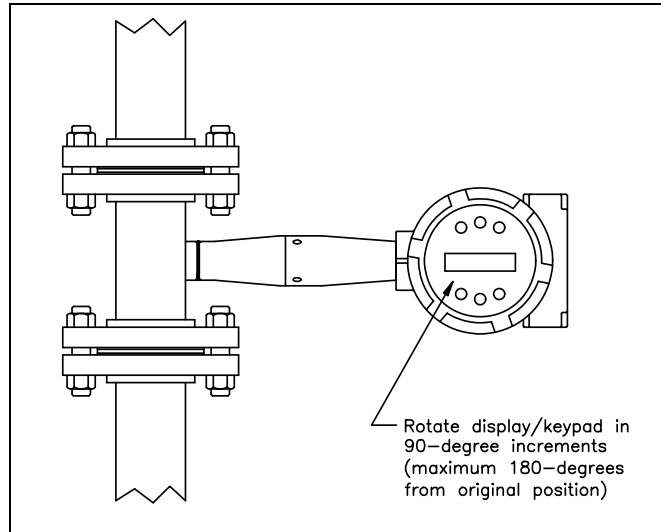

Figure 2-12. Display/Keypad Viewing Adjustment

The electronics boards are electrostatically sensitive. Wear a grounding wrist strap and make sure to observe proper handling precautions required for static-sensitive components. To adjust the display:

1. Disconnect power to the flow meter.
2. Loosen the small set screw which secures the electronics enclosure. Unscrew and remove the cover.
3. Loosen the 4 captive screws.
4. Carefully pull the display/microprocessor board away from the meter standoffs. Make sure not to damage the connected ribbon cable.
5. Rotate the display/microprocessor board to the desired position. Maximum turn, two positions left or two positions right (180-degrees).
6. Align the board with the captive screws. Check that the ribbon cable is folded neatly behind the board with no twists or crimps.
7. Tighten the screws. Replace the cover and set screw. Restore power to the meter.

Enclosure Adjustment (Series 240 Only)

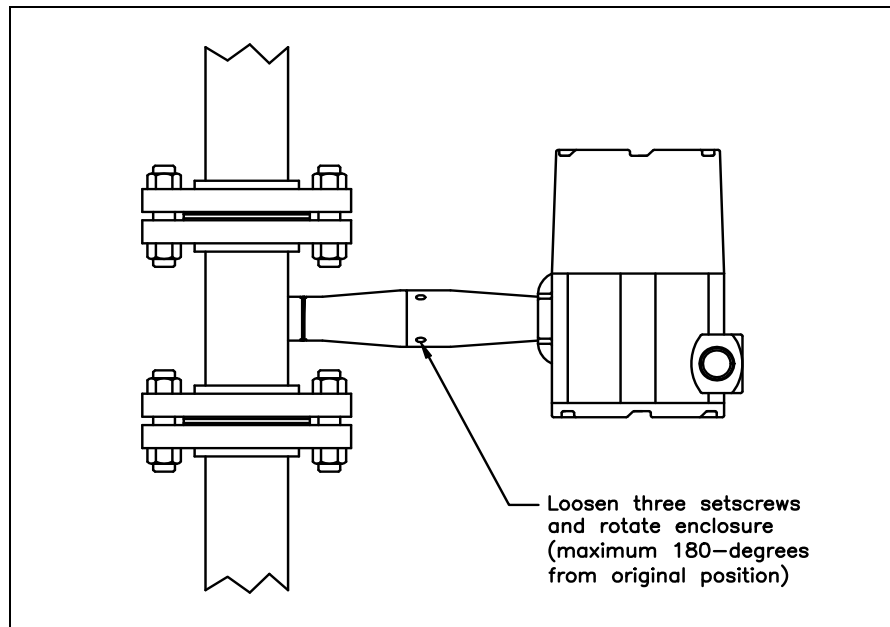

Figure 2-13. Enclosure Viewing Adjustment

To avoid damage to the sensor wires, do not rotate the enclosure beyond 180-degrees from the original position. To adjust the enclosure:

1. Remove power to the flow meter.
2. Loosen the three set screws shown above. Rotate the display to the desired position (maximum 180-degrees).
3. Tighten the three set screws. Restore power to the meter.

Wiring Connections



Warning!

To avoid potential electric shock, follow National Electric Code safety practices or your local code when wiring this unit to a power source and to peripheral devices. Failure to do so could result in injury or death. All AC power connections must be in accordance with published CE directives. All wiring procedures must be performed with the power off.



Caution!

The AC wire insulation temperature rating must meet or exceed 85°C (185°F).

The NEMA 4X enclosure contains an integral wiring compartment with one dual strip terminal block (located in the smaller end of the enclosure). Two 3/4-inch female NPT conduit entries are available for separate power and signal wiring. For all hazardous area installations, make sure to use an agency-approved fitting at each conduit entry. If conduit seals are used, they must be installed within 18 inches (457 mm) of the enclosure.

Input Power Connections

To access the wiring terminal blocks, locate and loosen the small set screw which locks the small enclosure cover in place. Unscrew the cover to expose the terminal block.

AC Power Wiring

The AC power wire size must be 20 to 10 AWG with the wire stripped 1/2 inch (14 mm). The wire insulation temperature must meet or exceed 85°C (185°F). Connect 100 to 240 VAC (25 watts maximum) to the Hot and Neutral terminals on the terminal block. Connect the ground wire to the safety ground lug. Torque all connections to 4.43 to 5.31 in-lbs (0.5 to 0.6 Nm). Use a separate conduit entry for signal lines to reduce the possibility of AC noise interference.

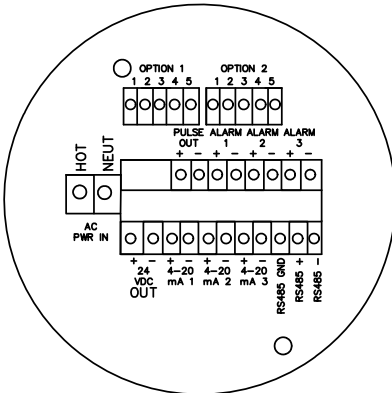

AC Terminals

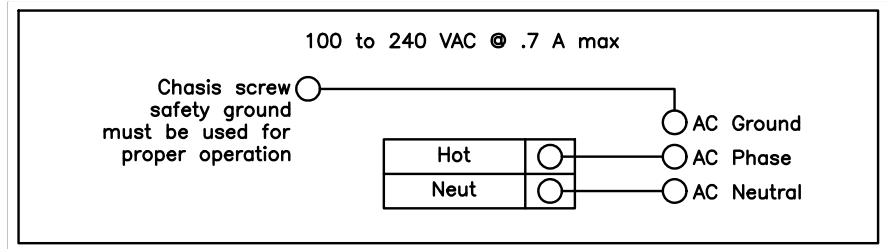
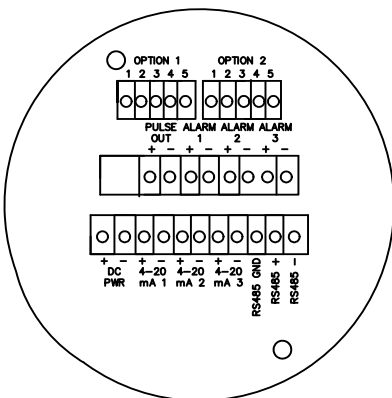

Figure 2-14. AC Power Connections



DC Terminals

DC Power Wiring

The DC power wire size must be 20 to 10 AWG with the wire stripped 1/2 inch (14 mm). Connect 18 to 36 VDC (100 mA maximum current draw) to the +Pwr and -Pwr terminals on the terminal block. Torque all connections to 4.43 to 5.31 in-lbs (0.5 to 0.6 Nm).

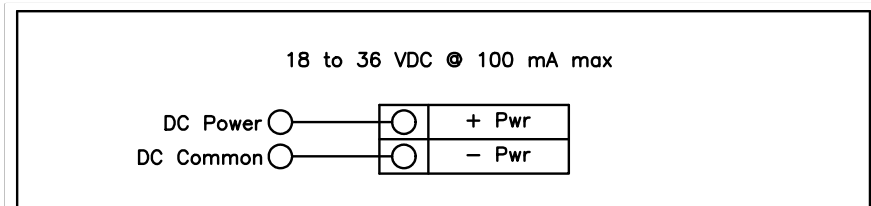

Figure 2-15. DC Power Connections

4-20 mA Output Connections

The standard Innova-Mass Flow Meter has a single 4-20 mA loop. Two additional loops are available on the optional communication board. The 4-20 mA loop current is controlled by the meter electronics. The electronics must be wired in series with the sense resistor or current meter. The current control electronics require 12 volts at the input terminals to operate correctly.

The maximum loop resistance (load) for the current loop output is dependent upon the supply voltage and is given in Figure 2-16. The 4-20 mA loop is optically isolated from the flow meter electronics.

R_{load} is the total resistance in the loop, including the wiring resistance ($R_{load} = R_{wire} + R_{sense}$). To calculate R_{max} , the maximum R_{load} for the loop, use the maximum loop current, 20 mA. The voltage drop in the loop due to resistance is 20 mA times R_{load} and this drop is subtracted from the input voltage. Thus:

$$\text{The maximum resistance } R_{load} = R_{max} = 50 * (V_{supply} - 12V).$$

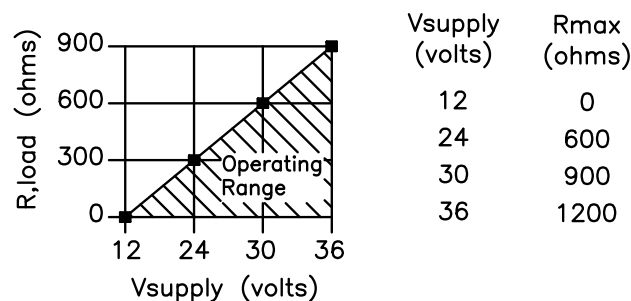

Figure 2-16. Load Resistance Versus Input Voltage

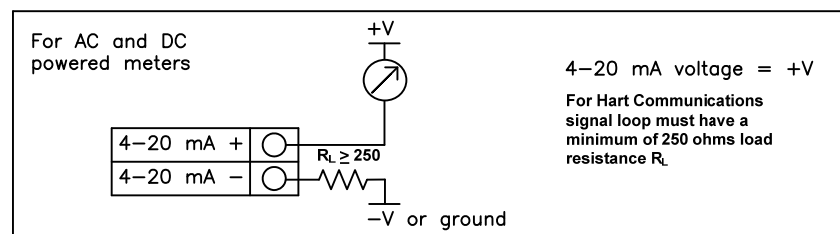

Figure 2-17. Isolated 4-20 mA Output with External Power Supply

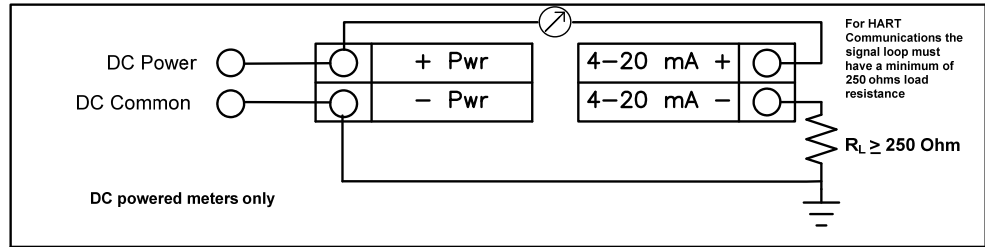

Figure 2-18. Non-Isolated 4–20 mA Output Using Meter Input Power Supply

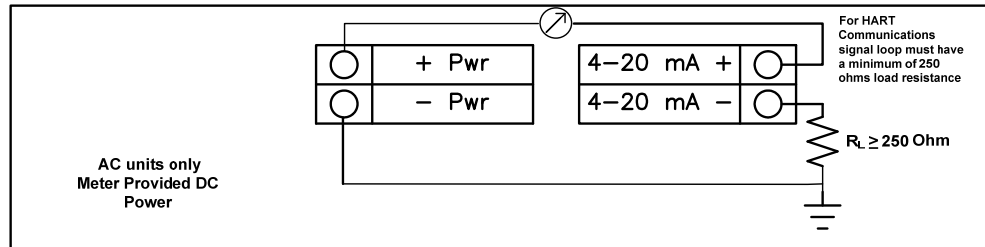

Figure 2-19. Isolated 4–20 mA Output using Meter Provided Power Supply

Pulse Output Connections

The pulse output is used for a remote counter. When the preset volume or mass (defined in the totalizer settings, see page 3-7) has passed the meter, the output provides a 50 millisecond square pulse.

The pulse output optical relay is a normally-open single-pole relay. The relay has a nominal 200 volt/160 ohm rating. This means that it has a nominal on-resistance of 160 ohms, and the largest voltage that it can withstand across the output terminals is 200 volts. However, there are current and power specifications that must be observed. The relay can conduct a current up to 40 mA and can dissipate up to 320 mW. The relay output is isolated from the meter electronics and power supply.

There are two connection options for the pulse output—the first with a separate power supply (Figure 2-19) and the second using the flow meter power supply (Figure 2-20). Use the first option with a separate power supply (5 to 36 VDC) if a specific voltage is needed for the pulse output. Use the second configuration if the voltage at the flow meter power supply is an acceptable driver voltage for the load connected. (Take into account that the current used by the pulse load comes from the meter’s power supply.) In either case, the voltage of the pulse output is the same as the voltage supplied to the circuit.

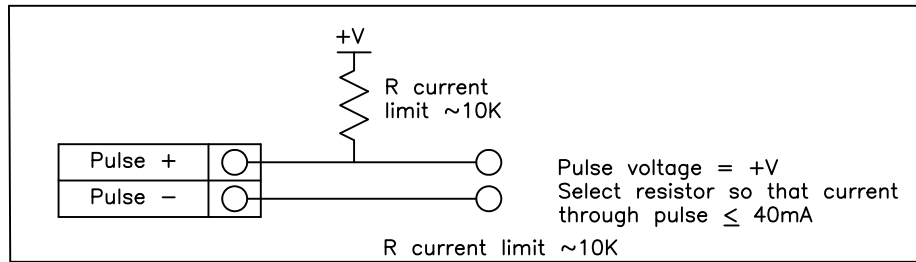

Figure 2-20. Isolated Pulse Output with External Power Supply

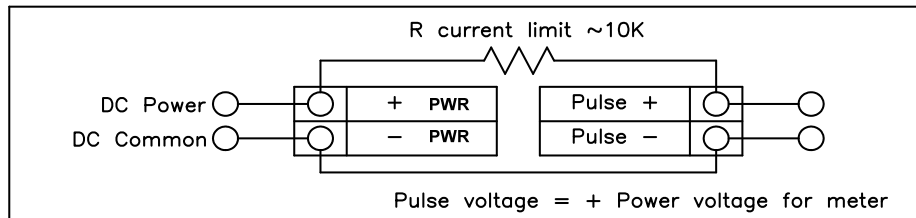

Figure 2-21. Non-Isolated Pulse Output Using Input Power Supply

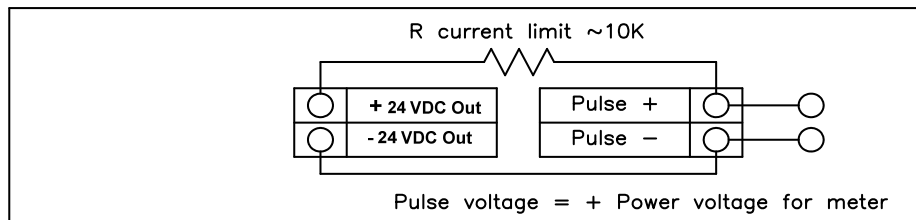

Figure 2-22. Isolated Pulse Output Using Meter Provided Power Supply

Alarm Output Connections

One alarm output (Alarm 1) is included on the standard Innova-Mass™ Flow Meter. Two or more alarms (Alarm 2 and Alarm 3) are included on the optional communication board. The alarm output optical relays are normally-open single-pole relays. The relays have a nominal 200 volt/160 ohm rating. This means that each relay has a nominal on-resistance of 160 ohms and the largest voltage that it can withstand across the output terminals is 200 volts. However, there are current and power specifications that must be observed. The relay can conduct a current up to 40 mA and can dissipate up to 320 mW. The relay output is isolated from the meter electronics and power supply. When the alarm relay is closed, the current draw will be constant. Make sure to size R_{load} appropriately.

There are two connection options for the alarm output—the first with a separate power supply (Figure 2-21) and the second using the flow meter power supply (Figure 2-22). Use the first option with a separate power supply (5 to 36 VDC) if a specific voltage is needed for the alarm output. Use the second configuration if the voltage at the flow meter power supply is an acceptable driver voltage for the load connected. (Take into account that the current used by the alarm load comes from the meter's power supply.) In either case, the voltage of the alarm output is the same as the voltage supplied to the circuit.

The alarm output is used for transmitting high or low process conditions as defined in the alarm settings (see page 3-6).

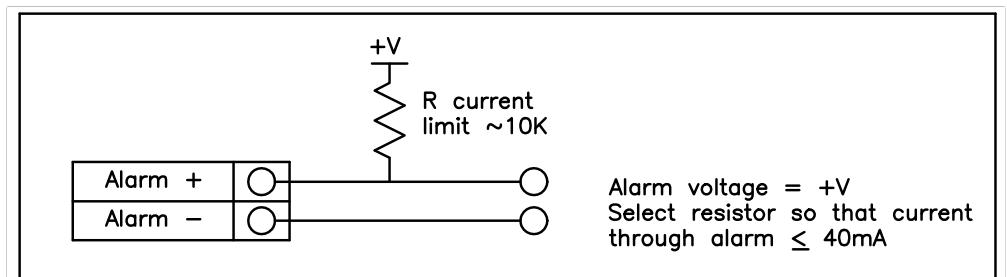

Figure 2-22. Isolated Alarm Output with External Power Supply

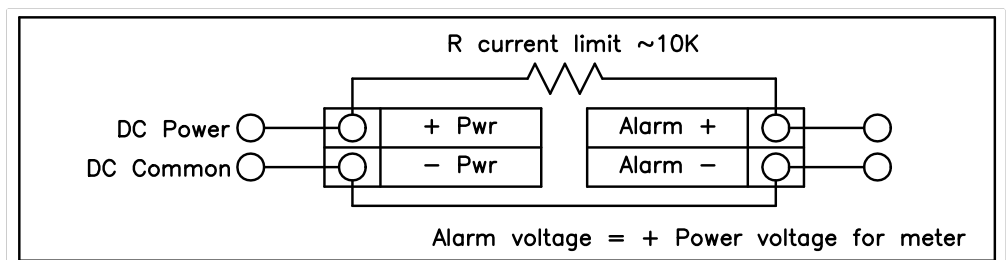

Figure 2-23. Non-Isolated Alarm Output Using Internal Power Supply

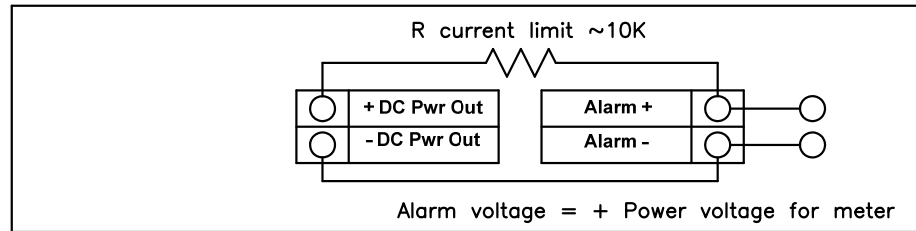

Figure 2-24. Isolated Alarm Output Using Meter Provided Power Supply

Remote Electronics Wiring

The remote electronics enclosure should be mounted in a convenient, easy to reach location. For hazardous location installations, make sure to observe agency requirements for installation. Allow some slack in the interface cable between the junction box and the remote electronics enclosure. To prevent damage to the wiring connections, do not put stress on the terminations at any time.

The meter is shipped with temporary strain relief glands at each end of the cable. Disconnect the cable from the meter's terminal block inside the junction box—not at the remote electronics enclosure. Remove both glands and install appropriate conduit entry glands and conduit. When installation is complete, re-connect each labeled wire to the corresponding terminal position on the junction box terminal block. Make sure to connect each wire pair's shield. Note: incorrect connection will cause the meter to malfunction.

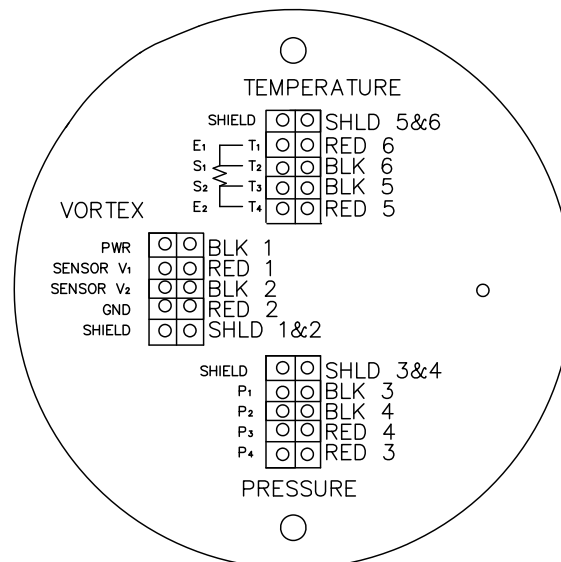
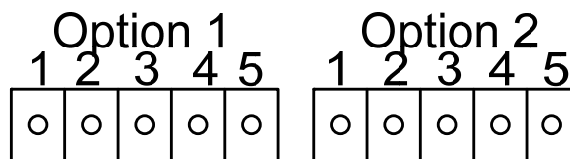

Figure 2-24. Junction Box Sensor Connections

Note: Numeric code in junction box label matches wire labels.

Optional Input Electronics Wiring

The meter has two optional input wiring terminals. These can be used to input a Remote or Second RTD input in the case of an Energy Monitoring meter, for the input of a Remote Pressure Transducer, to pass a Contact Closure or for a Remote Density measurement to name a few. In any case, the wiring diagram will be included with the meter if any of the options are specified. Otherwise, the optional terminal blocks will be left blank and non functional.



Optional Input Electronics Wiring

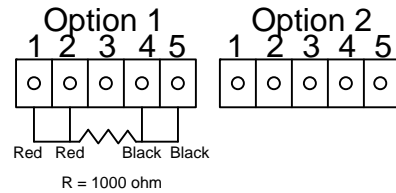

The recommended customer supplied second RTD is a Class A 1000 ohm 4-wire platinum RTD. If a second RTD is not being used, then the factory supplied 1000 ohm resistor needs to be installed in its place.

Chapter 3 Operating Instructions

After installing the Innova-Mass Vortex Flow Meter, you are ready to begin operation. The sections in this chapter explain the display/keypad commands, meter start-up and programming. The meter is ready to operate at start up without any special programming. To enter parameters and system settings unique to your operation, see the following pages for instructions on using the setup menus.

Flow Meter Display/Keypad

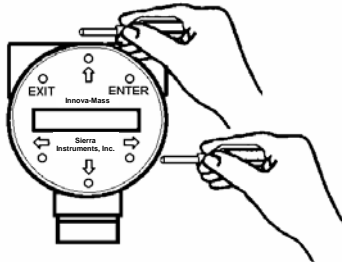

The flow meter's digital electronics allow you to set, adjust and monitor system parameters and performance. A full range of commands are available through the display/keypad. The LCD display gives 2 x 16 characters for flow monitoring and programming. The six push-buttons can be operated with the enclosure cover removed. Or, the explosion-proof cover can remain in place and the keypad operated with a hand-held magnet positioned at the side of the enclosure as shown in the illustration at the left.

Display/Keypad Commands	
<p>The diagram shows the keypad and display area of the flow meter. It features a central LCD display with the text 'Innova-Mass™' and 'Sierra INSTRUMENTS' below it. Surrounding the display are six push-buttons: 'EXIT' (top left), 'ENTER' (top right), and four arrow keys (up, down, left, right) arranged in a circle around the display. The keypad is shown within a circular enclosure cover.</p>	<p>From the Run Mode, the ENTER key allows access to the Setup Menu (through a password screen). Within the Setup Menu, pressing ENTER activates the current field. To set new parameters, press the ENTER key until an underline cursor appears. Use the \uparrow \downarrow \leftarrow \rightarrow keys to select new parameters. Press ENTER to continue. (If change is not allowed, ENTER has no effect.) All outputs are disabled when using the Setup Menu.</p> <p>The EXIT key is active within the Setup Menu. When using a Setup Menu, EXIT returns you to the Run Mode. If you are changing a parameter and make a mistake, EXIT allows you to start over.</p> <p>The \uparrow \downarrow \leftarrow \rightarrow keys advance through each screen of the current menu. When changing a system parameter, all \uparrow \downarrow \leftarrow \rightarrow keys are available to enter new parameters.</p>

Figure 3-1. Flow Meter Display/Keypad

Start-Up

To begin flow meter operation:

1. Verify the flow meter is installed and wired as described in Chapter 2.
2. Apply power to the meter. At start up, the unit runs a series of self-tests that check the RAM, ROM, EPROM and all flow sensing components. After completing the self-test sequence, the Run Mode screens appear.
3. The Run Mode displays flow information as determined by system settings. Press the $\uparrow\downarrow$ arrow keys to view the Run Mode screens.
4. Press the ENTER key from any Run Mode screen to access the Setup Menu. Use the Setup Menus to configure the meter's multi-parameter features to fit your application.



Note

Starting the flow meter or pressing EXIT will always display the Run Mode screens.

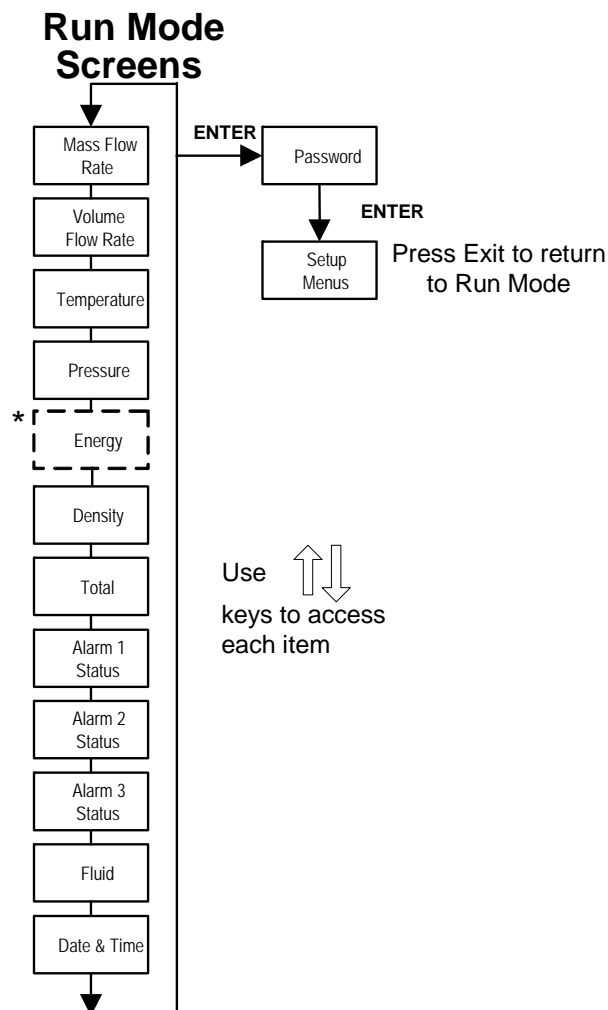

Using the Setup Menus

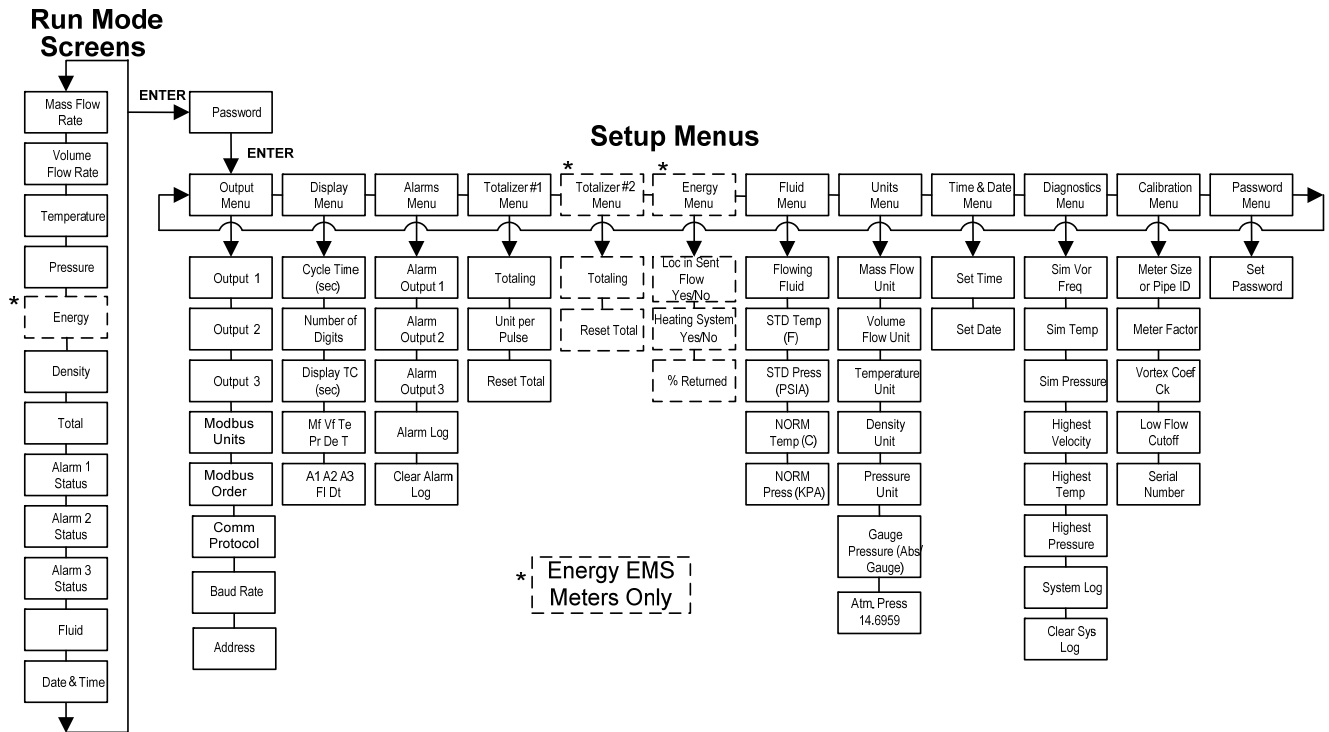

Programming the Flow Meter

1. Enter the Setup Menu by pressing the ENTER key until prompted for a password. (All outputs are disabled while using the Setup Menus.)
2. Use the \uparrow \downarrow \leftarrow \rightarrow keys to select the password characters (1234 is the factory-set password). When the password is correctly displayed, press ENTER to continue.
3. Use the Setup Menu described on the following pages to customize the multi-parameter features of your Innova-Mass Flow Meter. (The entire lower display line is available for entering parameters.)
4. To activate a parameter, press ENTER. Use the \uparrow \downarrow \leftarrow \rightarrow keys to make selections. Press ENTER to continue. Press EXIT to save or discard changes and return to Run Mode.
5. **Program the UNITS menu first because later menus will be based on the units selected.**

Output Menu

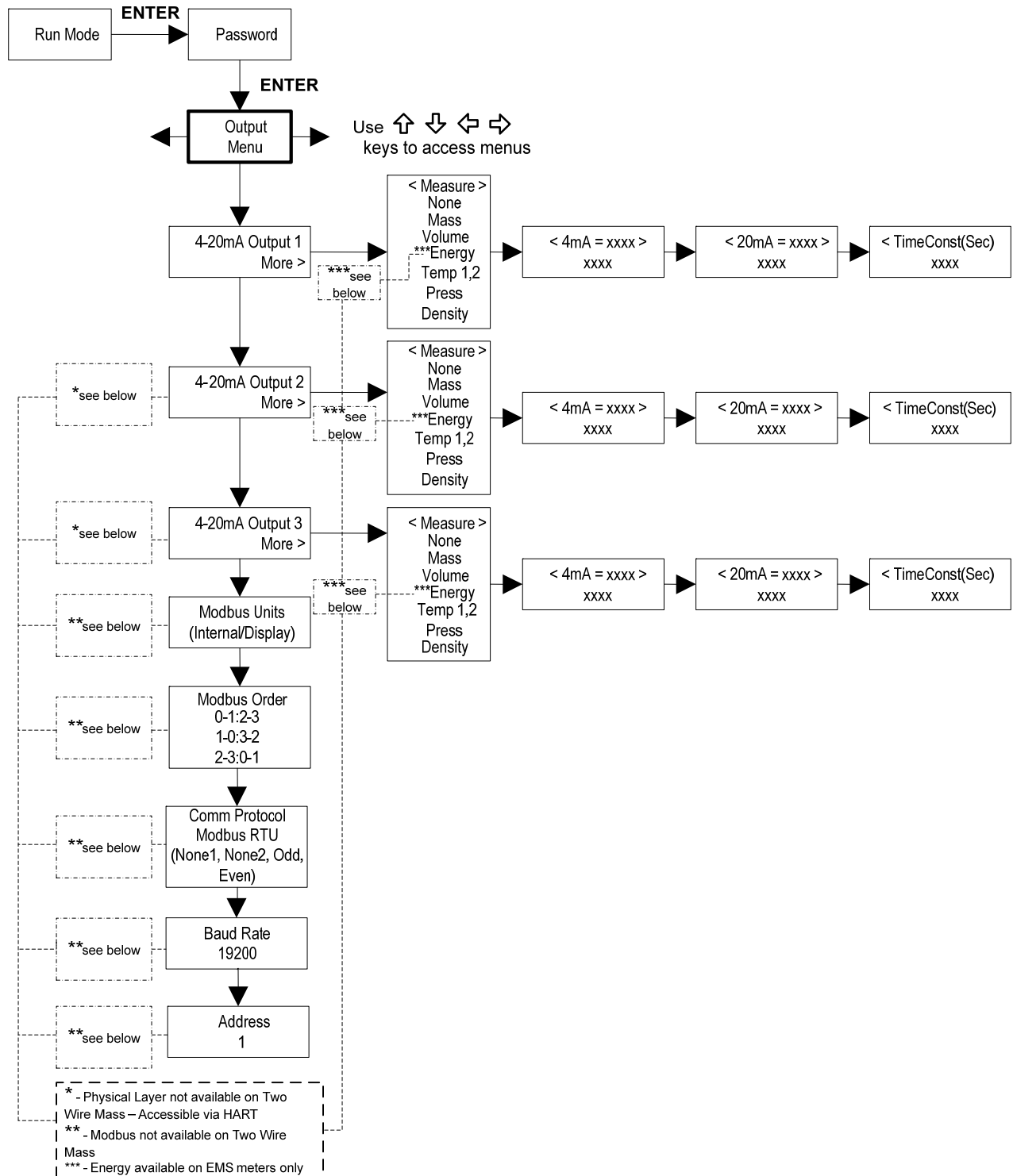

Example for Setting an Output

The following shows how to set Output 1 to measure mass flow with 4 mA = 0 lb/hr and 20 mA = 100 lb/hr with a time constant of 5 seconds. (All outputs are disabled while using the Setup Menus.)

First, set the desired units of measurement:

1. Use $\leftarrow\rightarrow$ keys to move to the Units Menu (see page 3-9).
2. Press \downarrow key until Mass Flow Unit appears. Press ENTER.
3. Press \downarrow key until lb appears in the numerator. Press \rightarrow key to move the underline cursor to the denominator. Press the \downarrow key until hr appears in the denominator. Press ENTER to select.
4. Press \uparrow key until Units Menu appears.

Second, set the analog output:

1. Use $\leftarrow\rightarrow$ keys to move to the Output Menu.
2. Press the \downarrow key until 4-20 mA Output 1 appears.
3. Press \rightarrow key to access Measure selections. Press ENTER and press the \downarrow key to select Mass. Press ENTER.
4. Press \rightarrow key to set the 4 mA point in the units you have selected for mass of lb/hr. Press ENTER and use $\uparrow\downarrow\leftarrow\rightarrow$ keys to set 0 or 0.0. Press ENTER.
5. Press \rightarrow key to set the 20 mA point. Press ENTER and use $\uparrow\downarrow\leftarrow\rightarrow$ keys to set 100 or 100.0. Press ENTER.
6. Press \rightarrow key to select the Time Constant. Press ENTER and use $\uparrow\downarrow\leftarrow\rightarrow$ keys to select 5. Press ENTER.
7. Press the EXIT key and answer YES to permanently save your changes.

Display Menu

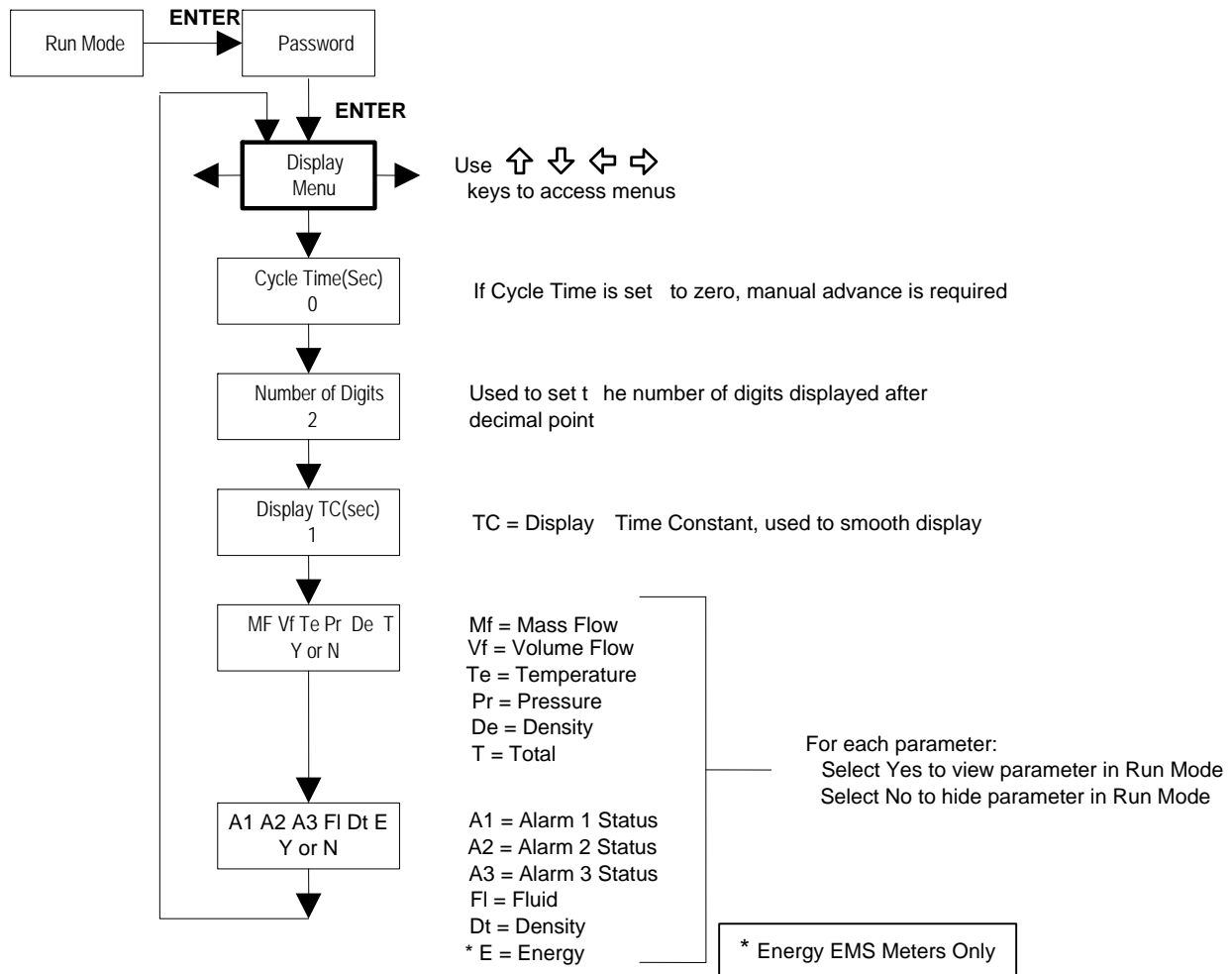

Use the Display Menu to set the cycle time for automatic screen sequencing used in the Run Mode, change the precision of displayed values, smooth the values or enable or disable each item displayed in the Run Mode screens.

Example for Changing a Run Mode Display Item

The following shows how to remove the temperature screen from the Run Mode screens. Note: all outputs are disabled while using the Setup Menus.

1. Use ← → keys to move to the Display Menu.
2. Press ↓ key until Mf Vf Pr Te De T appears.
3. Press ENTER to select. Press → key until the cursor is positioned below Te.
4. Press ↓ key until N appears. Press ENTER to select.
5. Press EXIT and then ENTER to save changes and return to the Run Mode.

Alarms Menu

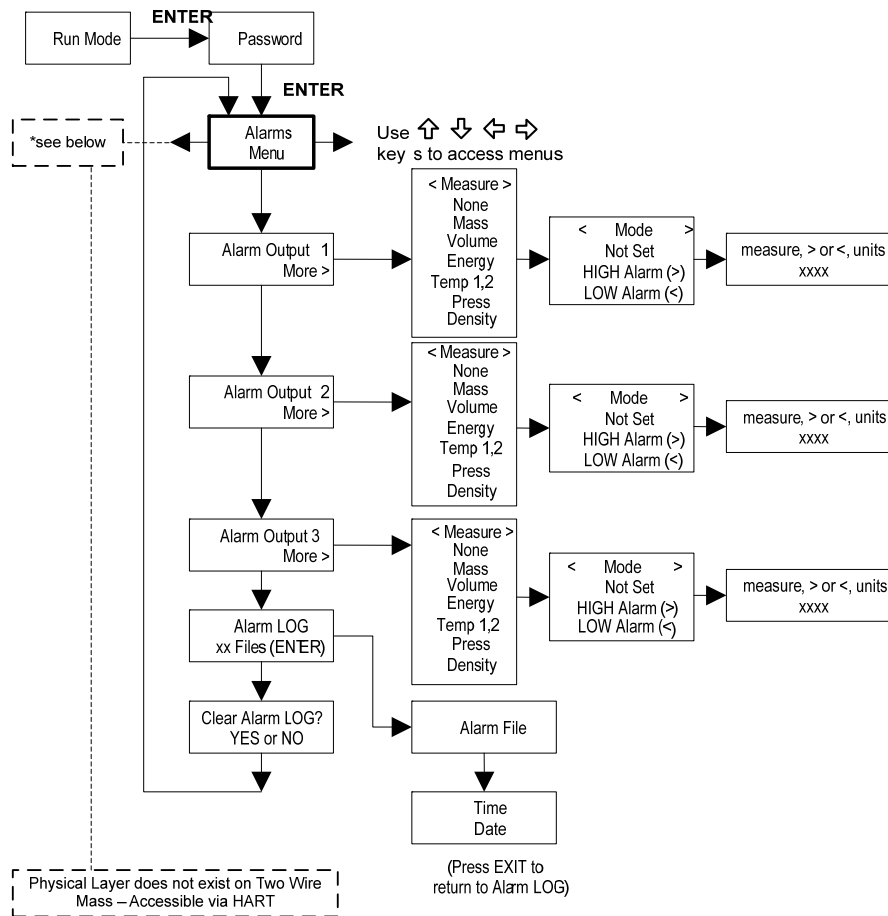

Example for Setting an Alarm

The following shows how to set Alarm 1 to activate if the mass flow rate is greater than 100 lb/hr. You can check the alarm configuration in the Run Mode by pressing the $\uparrow\downarrow$ keys until Alarm [1] appears. The lower line displays the mass flow rate at which the alarm activates. Note: all outputs are disabled while using the Setup Menus.

First, set the desired units of measurement:

1. Use $\leftarrow\rightarrow$ keys to move to the Units Menu (see to page 3-9).
2. Press \downarrow key until Mass Flow Unit appears. Press ENTER.
3. Press \downarrow key until lb appears in the numerator. Press \rightarrow key to move the underline cursor to the denominator. Press the \downarrow key until hr appears in the denominator. Press ENTER to select.
4. Press \uparrow key until Units Menu appears.

Second, set the alarm:

1. Use $\leftarrow\rightarrow$ keys to move to the Alarms Menu.
2. Press the \downarrow key until Alarm Output 1 appears.
3. Press \rightarrow key to access Measure selections. Press ENTER and use the \downarrow key to select Mass. Press ENTER.
4. Press \rightarrow key to select the alarm Mode. Press ENTER and use \downarrow key to select HIGH Alarm. Press ENTER.
5. Press \rightarrow key to select the value that must be exceeded before the alarm activates. Press ENTER and use $\uparrow\downarrow\leftarrow\rightarrow$ keys to set 100 or 100.0. Press ENTER.
6. Press the EXIT key to save your changes. (Alarm changes are always permanently saved.)
(Up to three alarm outputs are available depending on meter configuration.)

Totalizer #1 Menu

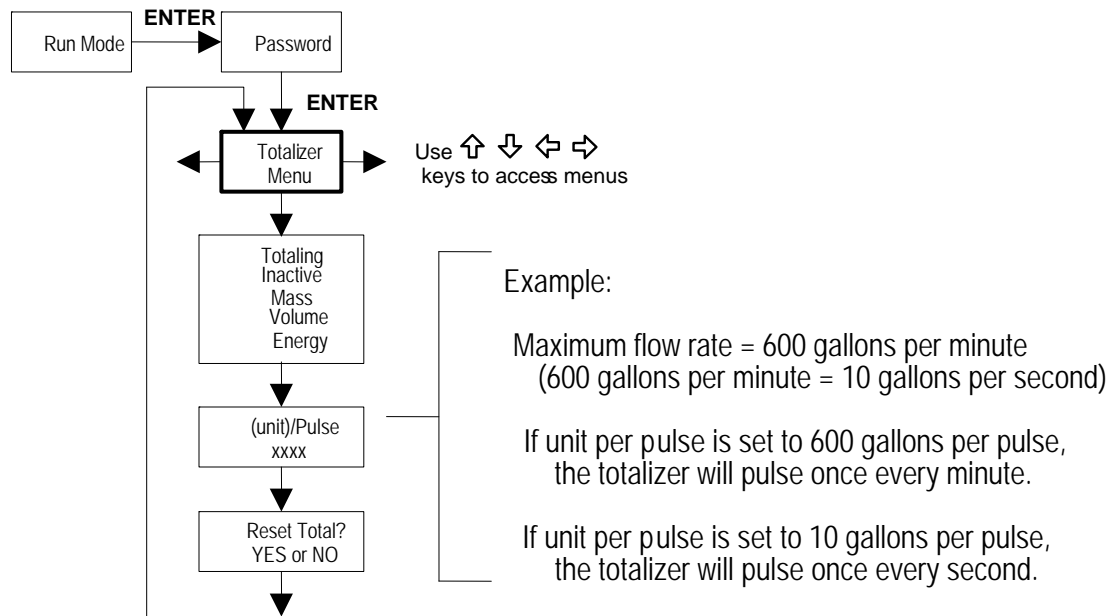

Use the Totalizer Menu to configure and monitor the totalizer. The totalizer output is a 50 millisecond (.05 second) positive pulse (relay closed for 50 milliseconds). The totalizer cannot operate faster than one pulse every 100 milliseconds (.1 second). A good rule to follow is to set the unit per pulse value equal to the maximum flow in the same units per second. This will limit the pulse to no faster than one pulse every second.

Example for Setting the Totalizer

The following shows how to set the totalizer to track mass flow in kg/sec. (All outputs are disabled while using the Setup Menus.)

First, set the desired units of measurement:

1. Use $\leftarrow \rightarrow$ keys to move to the Units Menu (see to page 3-9).
2. Press \downarrow key until Mass Flow Unit appears. Press **ENTER**.
3. Press \downarrow key until kg appears in the numerator. Press \rightarrow key to move the underline cursor to the denominator. Press the \downarrow key until sec appears in the denominator. Press **ENTER** to select.
4. Press \uparrow key until Units Menu appears.

Second, set the pulse output:

1. Use $\leftarrow \rightarrow$ keys to move to the Totalizer Menu.
2. Press the \downarrow key until Totaling appears.
3. Press **ENTER** and press the \downarrow key to select Mass. Press **ENTER**.
4. Press \downarrow key to set the pulse output in the units you have selected for mass flow of kg/sec. Press **ENTER** and use $\uparrow \downarrow \leftarrow \rightarrow$ keys to set the pulse value equal to the maximum flow in the same units per second. Press **ENTER**.
5. To reset the totalizer, press \downarrow key until Reset Total? appears. Press **ENTER** and the \downarrow key to reset the totalizer if desired. Press **ENTER**.
6. Press the EXIT key and answer YES to permanently save your changes.

Totalizer #2 Menu

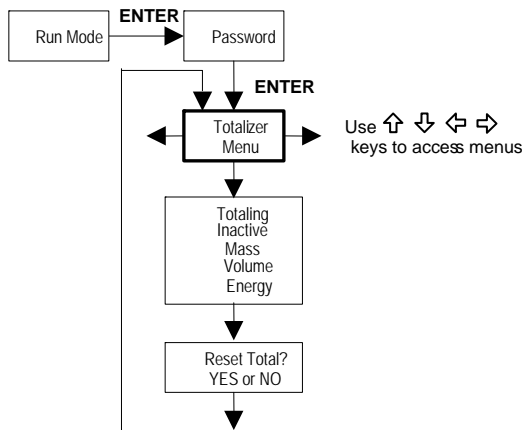

Use the Totalizer #2 to Monitor Flow or Energy. Note that Totalizer #2 does operate a relay it is for monitoring only.

Energy Menu – For EMS Energy Meters Only

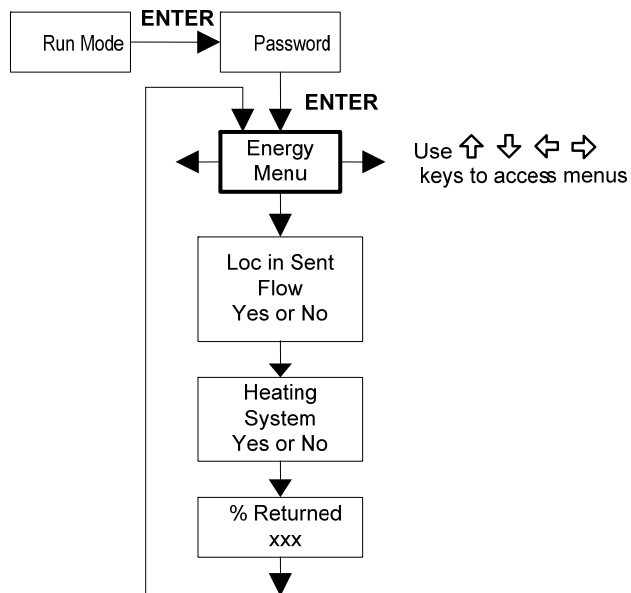

Configuration:

There are several possibilities regarding the measurement of water or steam energy given the location of the meter and the use of a second RTD. The table below summarizes the possibilities:

Fluid	Meter Location	Second RTD	Measurement
Water	“Sent” Flow Line	“Return Flow Line	Change in Energy
Water	“Return” Flow Line	“Sent” Flow Line	Change in Energy
Water	“Sent” Flow Line	None	Outgoing Energy
Steam	“Sent” Flow Line	“Return” Flow Line (condensate)	Change in Energy
Steam	“Sent” Flow Line	None	Outgoing Energy

As above, you must properly configure the meter in the Energy Menu.

1. Loc in Sent Flow? Select Yes or No based on where the meter is located. Refer to the above table
2. Heating System? Select Yes for a hot water system used for heating. Select No for a chilled water system used for cooling. Always select Yes for a steam system.
3. % Returned. Select a number between 0% and 100%. Estimate the amount of water that returns. It is usually 100%, or can be less than 100% if historical data shows the amount of makeup water used. If a second RTD is not used, set to 0%. When 0% is selected, the energy calculation represents the outgoing energy only (not return energy is subtracted).

Fluid Menu

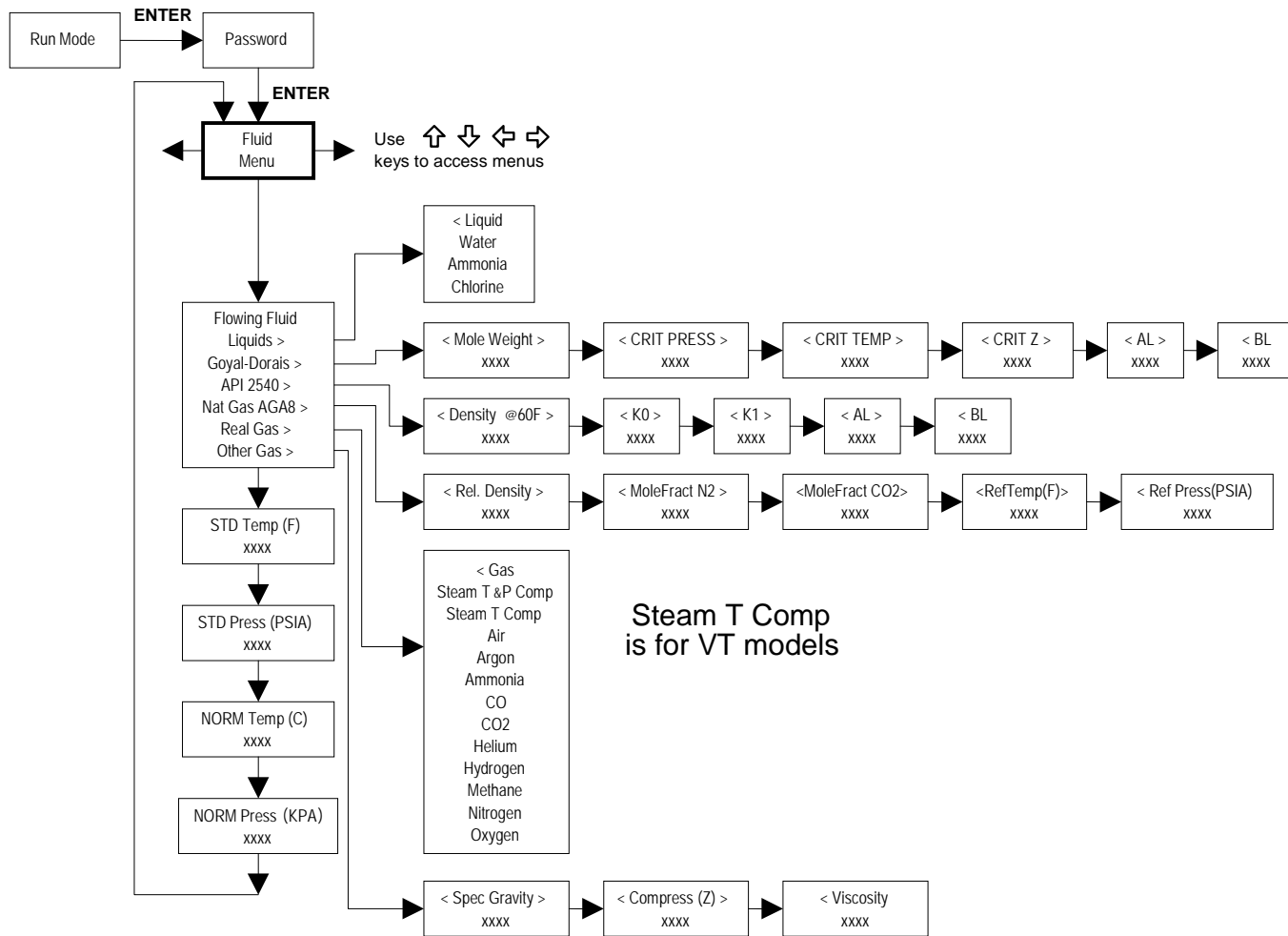

Use the Fluid Menu to configure the flow meter for use with common gases, liquids and steam. Your flow meter is pre-programmed at the factory for your application's process fluid.

Reference Richard W. Miller, *Flow Measurement Engineering Handbook (Second Edition, 1989)*, page 2-67 for definition and use of the Goyal-Doraiswamy equation and page 2-68 for the definition and use of the API 2540 equation. Also, see Appendix C for Fluid Calculation equations.

The units of measurement used in the Fluid Menu are preset and are as follows:
 Mole Weight = $\text{lb}_m/(\text{lb}_m \cdot \text{mol})$, CRIT PRESS = psia, CRIT TEMP = °R, Density = Kg/m^3 and
 Viscosity = cP (centipoise).

Units Menu

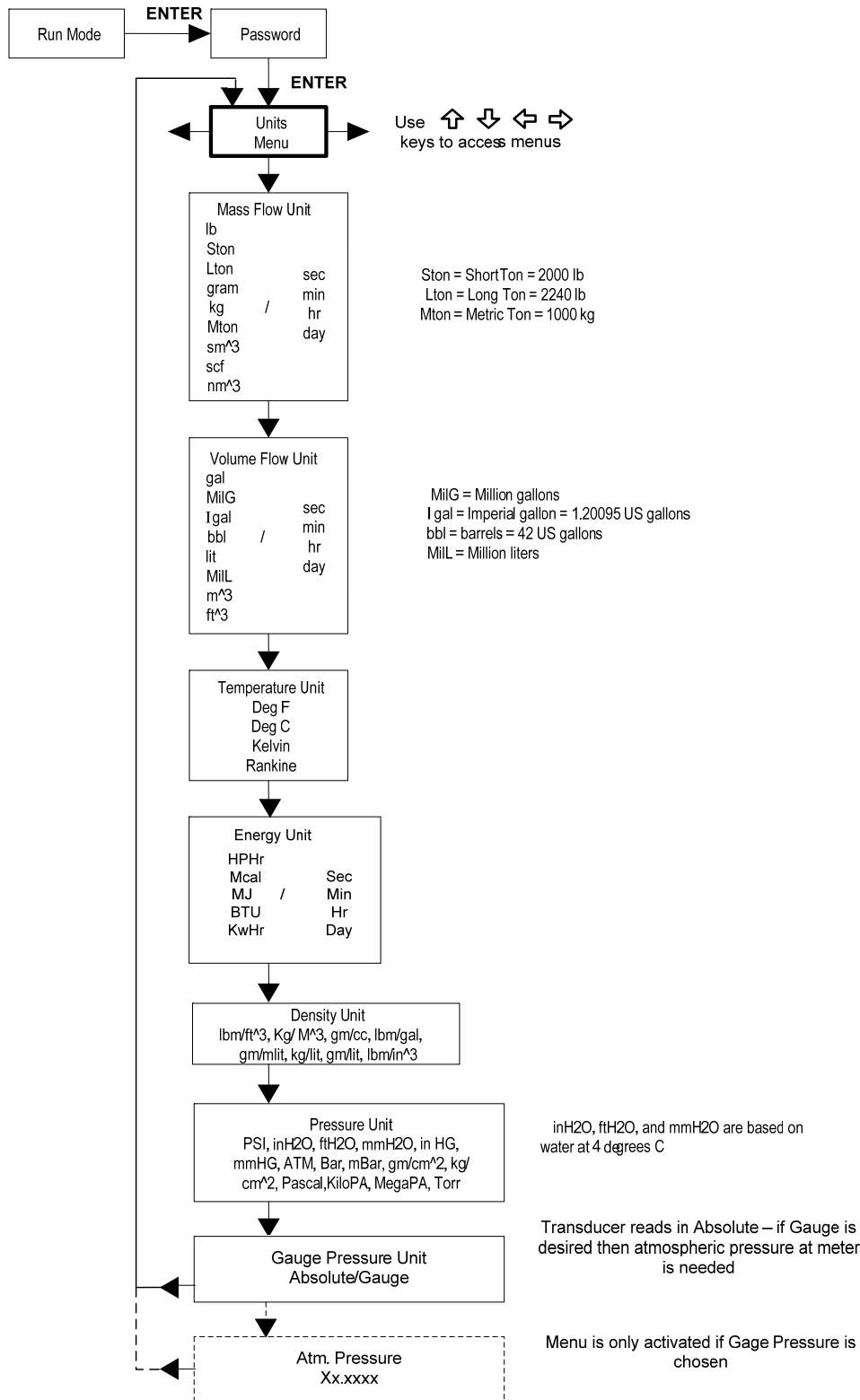

Use the Units Menu to configure the flow meter with the desired units of measurement. (These are global settings and determine what appears on all screens.)

Time & Date Menu

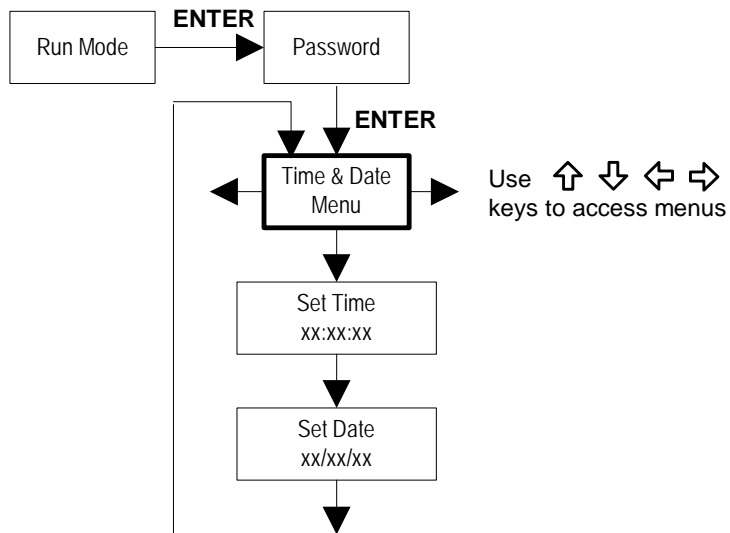

Use the Time and Date Menu to enter the correct time and date into the flow meter's memory. The parameters are used in the Run Mode and the alarm and system log files.

Note: Time is displayed in AM/PM format, but military format is used to set the time. For example, 1:00 PM is entered as 13:00:00 in the Set Time menu.

Example for Setting the Time

How to set the time to 12:00:00. You can check the time in the Run Mode by pressing the keys until the Time & Date screen appears. Note: all outputs are disabled while using the Setup Menus.

1. Use keys to move to the Time and Date Menu.
2. Press key until Set Time appears. Press ENTER.
3. Press key until 1 appears. Press key to move the underline cursor to the next digit. Press the key until 2 appears. Continue sequence until all desired parameters are entered. Press ENTER to return to the Time and Date Menu.
4. Press **EXIT** to return to the Run Mode.

Diagnostics Menu

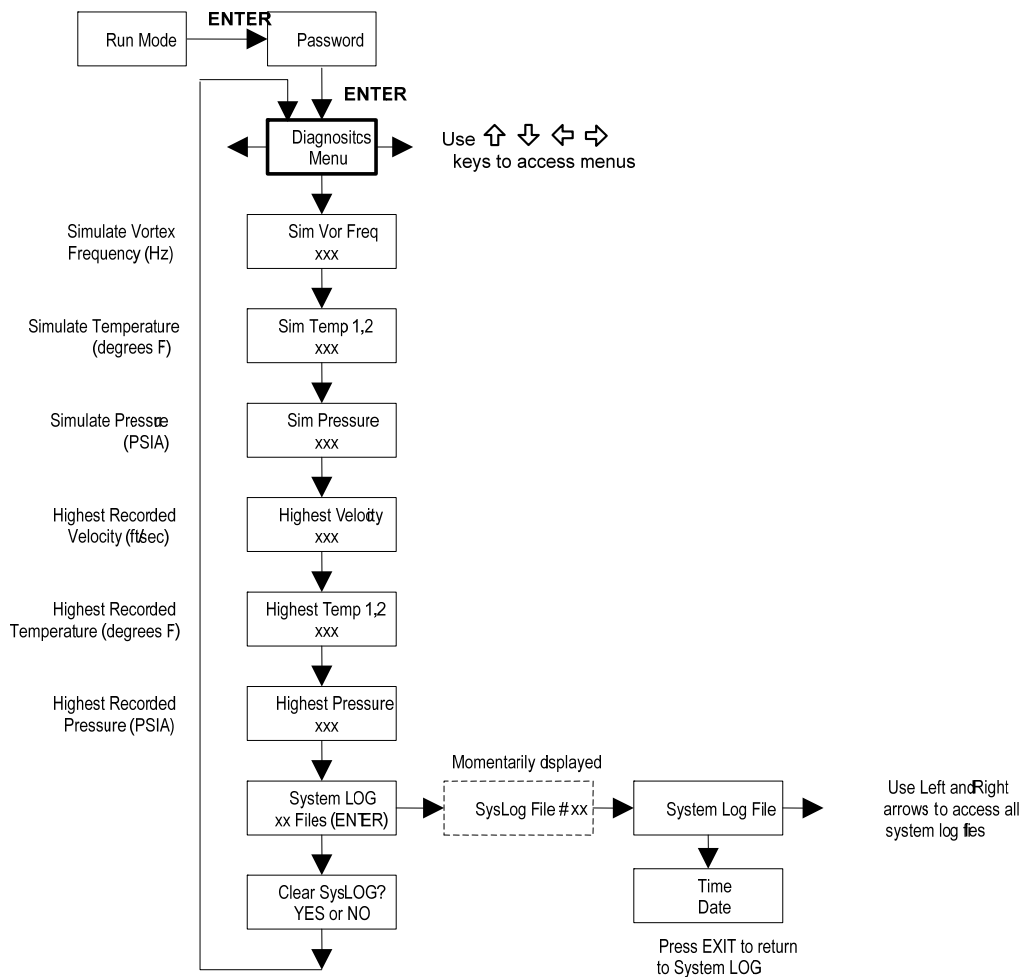

Use the Diagnostics Menu to simulate operation and review the system files. The system log files contain time/date stamped messages including: power on, power off, programming time outs, parameter faults, incorrect password entry and other various information relative to system operation and programming.

The simulated inputs are for testing the meter to verify that the programming is correct. Simulated vortex frequency allows you to enter any value for the sensor input in Hz. The meter will calculate a flow rate based on the corresponding value and update all analog outputs (**the totalizer display and output is not affected by a simulated frequency**). The simulated pressure and temperature settings work the same way. The meter will output these new values and will use them to calculate a new density for mass flow measurement. Note: when your diagnostic work is complete, make sure to return the values to zero to allow the electronics to use the actual transducer values.

If the meter display indicates a temperature or pressure fault, a substitute value can be entered to allow flow calculations to continue at a fixed value until the source of the fault is identified and corrected. **Use only the units listed above for simulated values.** If different units are displayed, the value must be converted into the units listed above, and the displayed value will be automatically converted into the display units.

Calibration Menu

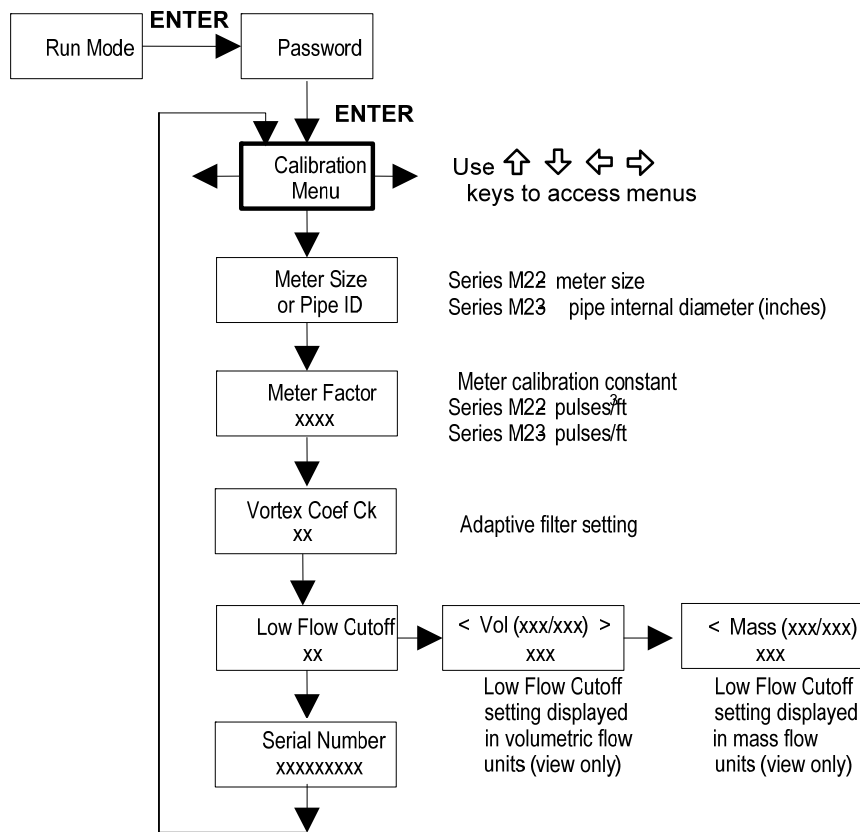

The Calibration Menu contains the calibration coefficients for the flow meter. These values should be changed only by properly trained personnel. The Vortex Coef Ck and Low Flow Cutoff are set at the factory. Consult the factory for help with these settings if the meter is showing erratic flow rate.

Password Menu

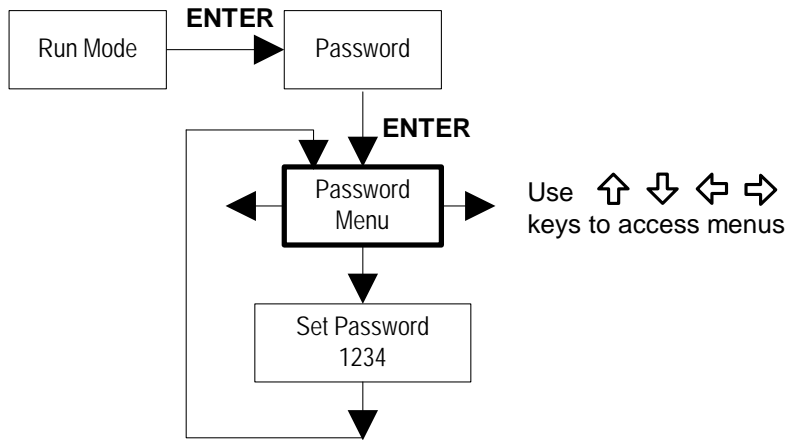

Use the Password Menu to set or change the system password. The factory-set password is 1234.

Chapter 4 Troubleshooting and Repair



Warning!

Before attempting any flow meter repair, verify that the line is not pressurized. Always remove main power before disassembling any part of the mass flow meter.

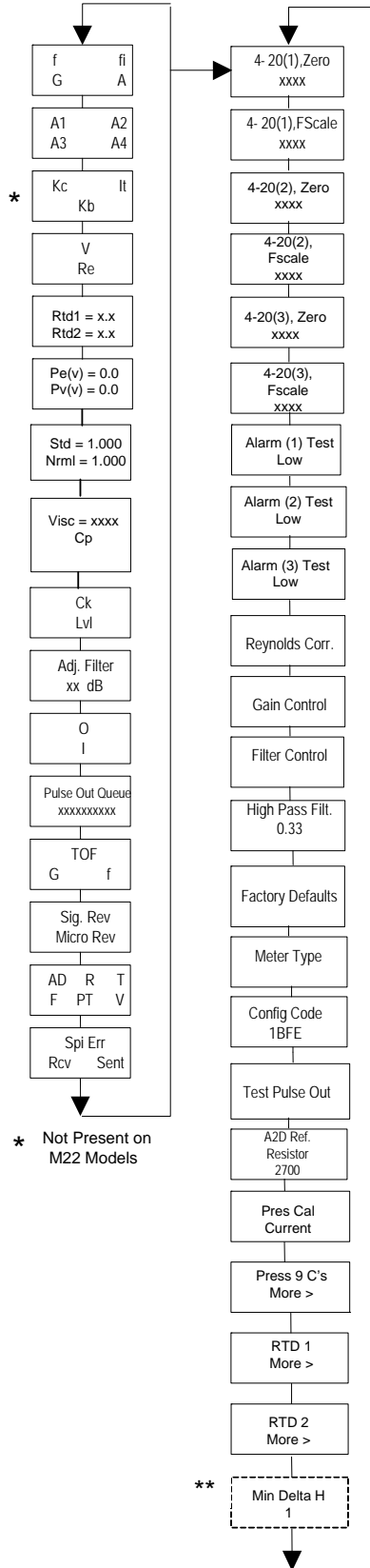

* Not Present on M22 Models

**

** Energy EMS Meters Only

Hidden Diagnostics Menus

The menus shown to the left can be accessed using the password 16363, then moving to the display that reads “Diagnostics Menu” and pressing ENTER (rather than one of the arrow keys).

Use the right arrow key to move to the second column. Press EXIT to move from the second column back to the first, press EXIT while in the first column to return to the setup menus.

Caution: password 16363 will allow full access to the configuration and should be used carefully to avoid changes that can adversely alter the function of the meter.

Each of the menus to the left will first be defined followed by specific troubleshooting steps.

Column One Hidden Diagnostics Values

- **f** = vortex shedding frequency (Hz).
- **fi** = adaptive filter – should be approximately 25% higher than the vortex shedding frequency, this is a low-pass filter. If the meter is using the Filter Control (see below) in the manual mode, **fi** will be displayed as **fm**.
- **G** = gain (applied to vortex signal amplitude). Gain defaults to 1.0 and can be changed using the Gain Control (see below).
- **A** = Amplitude of vortex signal in Volts rms.
- **A1, A2, A3, A4** = A/D counts representing the vortex signal amplitude. Each stage (A1-A4) cannot exceed 512. Beginning with stage A1, the A/D counts increase as the flow increases. When stage A1 reaches 512, it will shift to stage A2. This will continue as the flow rate increases until all 4 stages read 512 at high flow rates. Higher flow rates (stronger signal strength) will result in more stages reading 512.
- **Kc, It, Kb** = profile equation (factory use only). Model M23 only
- **V** = calculated average pipe velocity (ft/sec).
- **Re** = calculated Reynolds number.
- **RTD1** = resistance value of integral RTD in ohms.
- **RTD2** = optional RTD resistance value same as above
- **Pe(v)** = pressure transducer excitation voltage
- **Pv(v)** = pressure transducer sense voltage.
- **Stnd** = density of fluid at standard conditions
- **Nrml** = density of fluid at normal conditions
- **Viscosity** = calculated viscosity of flowing fluid
- **Ck** = calculated Ck at current operating conditions. Ck is a variable in the equation that relates signal strength, density, and velocity for a given application. It is used for noise rejection purposes. Ck directly controls the fi value (see above). If the Ck is set too low (in the calibration menu), then the fi value will be too low and the vortex signal will be rejected resulting in zero flow rate being displayed. The calculated Ck value in this menu can be compared to the actual Ck setting in the calibration menu to help determine if the Ck setting is correct.
- **Lvl** = threshold level. If the Low Flow Cutoff in the calibration menu is set above this value, the meter will read zero flow. The Lvl level can be checked at no flow. At no flow, the Lvl must be below the Low Flow Cutoff setting or the meter will have an output at no flow.

- **Adj. Filter** = adjustable filter. Displays the filtering in decibels. Normally reads zero. If this value is consistently -5 or -10, for example, the Ck or density setting may be wrong.
- **O,I** = factory use only.
- **Pulse Out Queue** = Pulse output queue. This value will accumulate if the totalizer is accumulating faster than the pulse output hardware can function. The queue will allow the pulses to “catch up” later if the flow rate decreases. A better practice is to slow down the totalizer pulse by increasing the value in the (unit)/pulse setting in the totalizer menu.
- **TOF, G, f** = factory use only.
- **Sig. Rev** = Signal board hardware and firmware revision.
- **Miro Rev** = Microprocessor board hardware and firmware revision.
- **AD, R, T, F, PT, V** = factory use only.
- **SPR Err, Rcv, Sent** = factory use only.

Column Two Hidden Diagnostics Values

- **4-20(1) Zero** = Analog counts to calibrate zero on analog output 1.
- **4-20(1) FScale** = Analog counts to cal. full scale on analog output 1.
- **4-20(2) Zero** = Analog counts to calibrate zero on analog output 2.
- **4-20(2) FScale** = Analog counts to cal. full scale on analog output 2.
- **4-20(3) Zero** = Analog counts to calibrate zero on analog output 3.
- **4-20(3) FScale** = Analog counts to cal. full scale on analog output 3.
- **Alarm (1) Test** = Used as a test to verify that the alarm circuit is functioning. When low is selected the alarm will initiate a low alarm on the output. When High is selected it will give a high alarm on the output.
- **Alarm (2) Test** = Used as a test to verify that the alarm circuit is functioning. When low is selected the alarm will initiate a low alarm on the output. When High is selected it will give a high alarm on the output.
- **Alarm (3) Test** = Used as a test to verify that the alarm circuit is functioning. When low is selected the alarm will initiate a

low alarm on the output. When High is selected it will give a high alarm on the output.

- **Reynolds Corr.** = Reynolds number correction for the flow profile. Set to Enable for M23 insertion and set to Disable for M22 inline.
- **Gain Control** = Manual gain control (factory use only). Leave set at 1.
- **Filter control** = Manual filter control. This value can be changed to any number to force the f_i value to a constant. A value of zero activates the automatic filter control which sets f_i at a level that floats above the f value.
- **High Pass Filter** = Filter setting – Factory use only
- **Factory Defaults** = Reset factory defaults. If you change this to Yes and press Enter, all the factory configuration is lost and you must reconfigure the entire program. Consult the factory before performing this process, it is required only in very rare cases.
- **Meter Type** = Insertion (M23) or Inline (M22) meter.
- **Config Code** = Factory Use Only
- **Test Pulse Out** = Force totalizer pulse. Set to Yes and press enter to send one pulse. Very useful to test totalizer counting equipment.
- **A2D Ref. Resistor** = Factory Use Only
- **Factory Defaults** = Reset to factory defaults. If you change this to YES and press ENTER, all factory configuration is lost and you must reconfigure the entire program. Consult the factory before performing this process, it is required only in very rare cases.
- **Force Tot Pulse** = Force totalizer pulse. Set to YES and press ENTER to send one pulse. Very useful to test totalizer counting equipment.
- **Pressure 9Cs** = Nine pressure coefficients unique to the pressure transducer. Use the RIGHT ARROW to access all nine coefficients.
- **Pressure Cal Current** = Calibration value for the electronics and pressure transducer combination. Consult Factory for value.
- **RTD1.** Press the RIGHT ARROW to access:
 - **Ro** = RTD resistance at 0°C (1000 ohms).
 - **A** = RTD coefficient A (.0039083).
 - **B** = RTD coefficient B (-5.775e-07).

- **Slope** = unique value for each set of electronics.
- **Int** = unique value for each set of electronics.
- **RTD2** = Second RTD configuration, for special applications only.
- **Min. Delta H** – Energy EMS meters only. Sets the deadband for totalization to begin. Must be greater than this number (1 default) to initiate the totalizer.

Analog Output Calibration

To check the 4–20 mA circuit, connect a DVM in series with the output loop. Select zero or full scale (from the second column of the hidden diagnostics) and then actuate the enter key twice. This action will cause the meter to output its 4 mA or 20 mA condition. If the DVM indicates a current greater than ± 0.006 mA from 4 or 20, adjust the setting up or down until the output is calibrated.

Note: these settings are not for adjusting the output zero and span to match a flow range, that function is located in the Output Menu.

Troubleshooting the Flow Meter

Symptom: Output at no Flow

1. The low flow cutoff is set too low. At no flow, go to the first column of the hidden diagnostics menu and record the Lvl value. The low flow cutoff must be set above this value.
2. Example: at no flow, Lvl = 25. Set the low flow cutoff in the Calibration Menu to approximately 28 and the meter will no longer read a flow rate at no flow.

Symptom: Erratic Output

1. The flow rate may be too low, just at the cutoff of the meter range, and the flow cycles above and below the cutoff making an erratic output. The meter range is stamped on the label on the outside of the electronics enclosure cover (based on application conditions when the meter was ordered). Consult the factory if necessary to confirm the meter range based on current operating conditions. It may be possible to lower the low flow cutoff to increase the meter range. See the example above for output at no flow, only this time the low flow cutoff is set too high. You can lower this value to increase the meter range as long as you do not create the output at no flow condition previously described.

2. Mechanical installation may be incorrect. Verify the straight run is adequate as described in Chapter 2. For in-line meters, make sure the meter is not installed backwards and there are no gaskets protruding into the flow stream. For insertion meters, verify the insertion depth and flow direction.
3. The meter may be reacting to actual changes in the flow stream. The output can be smoothed using a time constant. The displayed values can be smoothed using the time constant in the Display Menu. The analog outputs can be smoothed using the time constant in the Output Menu. A time constant of 1 will result in the change in value reaching 63% of its final value in one second. A time constant of 4 is 22%, 10 is 9.5% and 50 is 1.9% of the final value in one second. The time constant equation is shown below (TC = Time Constant).

$$\begin{array}{l} \text{\% change to final value} \\ \text{in one second} \end{array} = 100 (1 - e^{(-1/TC)})$$

4. The vortex coefficient Ck may be incorrectly set. The Ck is a value in the equation used to determine if a frequency represents a valid vortex signal given the fluid density and signal amplitude. In practice, the Ck value controls the adaptive filter, fi, setting. During flow, view the f and fi values in the first column of the hidden diagnostics. The fi value should be approximately 10-20 % higher than the f value. If you raise the Ck setting in the Calibration Menu, then the fi value will increase. The fi is a low pass filter, so by increasing it or lowering it, you can alter the range of frequencies that the meter will accept. If the vortex signal is strong, the fi value will increase to a large number – this is correct. Note: at high frequencies, the display may not be able to display all the digits of the fi value (for example, 114 may be displayed and the actual value is 1140).

Symptom: No Output

1. For remote mounted electronics, carefully check all the wiring connections in the remote mount junction box. There are 18 connections that must be correct, verify each color (black and red), shield, and wire number.
2. Turn on the pressure and temperature display in the Display Menu and verify that the pressure and temperature are correct.
3. Using ESD precautions and hazardous area precautions, remove the electronics enclosure window cover. Disconnect the

vortex sensor from the analog board (the analog board is the first board below the microprocessor (display) board. Measure the resistance from each outside pin to the meter ground - each should be open. Measure the resistance from the center pin to the meter ground – this should be grounded to the meter. With the sensor still disconnected, go to the first column of the hidden diagnostics and display the vortex shedding frequency, f. Hold a finger on the three exposed pins on the analog board. The meter should read electrical noise, 60 Hz for example. If all readings are correct, re-install vortex sensor wires.

4. Verify all meter configuration and troubleshooting steps previously described. There are many possible causes of this problem, consult factory if necessary.

Symptom: Meter Displays Temperature Fault

1. For remote mounted electronics, carefully check all the wiring connections in the remote mount junction box. There are 18 connections that must be correct, verify each color (black and red), shield, and wire number.
2. Go to the first column of the hidden diagnostics and check the resistance of the rtd1. It should be about 1080 ohms at room temperature.
3. Using ESD precautions and hazardous area precautions, remove the electronics enclosure window cover. Disconnect the temperature sensor (on the right) from the pressure / temperature board (the pressure / temperature board is the second board below the microprocessor (display) board. Measure the resistance across the outside pins of the temperature sensor connector. It should read approximately 1080 ohms at room temperature (higher resistance at higher temperatures). With the temperature sensor still disconnected, measure the current across the two outside pins of the exposed connector on the temperature / pressure board. The current should be approximately .0002 amps. Now reconnect the temperature sensor and measure the voltage across the two inside pins (insert probes into the connector where the wires enter it). This value should be approximately .2 volts (or .0002 amps times measured resistance, .216 volts at room temperature).
4. Consult factory with findings

Symptom: Meter Displays Pressure Fault

1. For remote mounted electronics, carefully check all the wiring connections in the remote mount junction box. There are 18 connections that must be correct, verify each color (black and red), shield, and wire number.
2. Using ESD precautions and hazardous area precautions, remove the electronics enclosure window cover. Disconnect the pressure sensor (on the left) from the pressure / temperature board (the pressure / temperature board is the second board below the microprocessor (display) board. Measure the resistance across the outside pins of the pressure sensor connector, then across the inside pins. Both readings should be approximately 4000 ohms. With the pressure sensor still disconnected, measure the current across the two outside pins of the exposed connector on the temperature / pressure board. The current should be approximately .0004 amps.
3. Go to the first column of the hidden diagnostics and record the Pe(V) and Pv(V) values and consult the factory with findings.

Electronics Assembly Replacement (All Meters)

The electronics boards are electrostatically sensitive. Wear a grounding wrist strap and make sure to observe proper handling precautions required for static-sensitive components.



Warning!
Before attempting any flow meter repair, verify that the line is not pressu-

1. Turn off power to the unit.
2. Locate and loosen the small set screw which locks the larger enclosure cover in place. Unscrew the cover to expose the electronics stack.
3. Locate the sensor harnesses which come up from the neck of the flow meter and attaches to the circuit boards. Use small pliers to pull the sensor wiring connectors off of the circuit boards.
4. Locate and loosen the small set screw which locks the smaller enclosure cover in place. Unscrew the cover to expose the field wiring strip. Tag and remove the field wires.
5. Remove the screws that hold the black wiring label in place, remove the label.
6. Locate the 4 Phillips head screws which are spaced at 90-degrees around the terminal board. These screws hold the elec-

tronics stack in the enclosure. Loosen these screws (Note: that these are captive screws, they will stay inside the enclosure).

7. Carefully remove the electronics stack from the opposite side of the enclosure. If the electronics stack will not come out, gently tap the terminal strip with the screw driver handle. This will loosen the rubber sealing gasket on the other side of the enclosure wall. Be careful that the stack does not hang up on the loose sensor harnesses.
8. Repeat steps 1 through 6 in reverse order to install the new electronics stack.

Pressure Sensor Replacement (Series M22 Only)

1. For local mounted electronics, remove the electronics stack as previously described. For remote mount electronics, remove all wires and sensor connectors from the remote feedthrough board in the junction box at the meter.
2. Loosen the three set screws at the center of the adapter between the meter and the enclosure.
3. Remove the top half of the adapter to expose the pressure transducer.
4. Remove the transducer and replace it with the new one using appropriate thread sealant.
5. Reassemble in reverse order.

Returning Equipment to the Factory

Before returning any Pro-V flow meter to the factory, you must request a Return Material Authorization (RMA) number. To obtain an RMA number and the correct shipping address, contact Customer Service at:

800-866-0200 or 831-373-0200 in the USA,

When contacting Customer Service, be sure to have the meter serial number and model code.

When requesting further troubleshooting guidance, record the following values first:

f, fi, G, and A at no flow and during flow if possible.
Pressure, temperature, and flow rate

Appendix A Product Specifications

Accuracy

Process Variables	240 Series In-Line Meters		241 Series Insertion Meters ⁽¹⁾	
	Liquids	Gas & Steam	Liquids	Gas & Steam
Mass Flow Rate	±1% of rate over a 30:1 range ⁽³⁾	±1.5% of rate ⁽²⁾ over a 30:1 range ⁽³⁾	±1.5% of rate over a 30:1 range ⁽³⁾	±2% of rate ⁽²⁾ over a 30:1 range ⁽³⁾
Volumetric Flow Rate	±0.7% of rate over a 30:1 range ⁽³⁾	±1% of rate over a 30:1 range ⁽³⁾	±1.2% of rate over a 30:1 range ⁽³⁾	±1.5% of rate over a 30:1 range ⁽³⁾
Temperature	± 2° F (± 1° C)	± 2° F (± 1° C)	± 2° F (± 1° C)	± 2° F (± 1° C)
Pressure	0.4% of transducer full scale	0.4% of transducer full scale	0.4% of transducer full scale	0.4% of transducer full scale
Density	0.3% of reading	0.5% of reading ⁽²⁾	0.3% of reading	0.5% of reading ⁽²⁾

- Notes: (1) Accuracies stated are for the total mass flow through the pipe.
 (2) Over 50 to 100% of the pressure transducer's full scale.
 (3) Nominal rangeability is stated. Precise rangeability depends on fluid and pipe size.

Repeatability

Mass Flow Rate: 0.2% of rate.
 Volumetric Flow Rate: 0.1% of rate.
 Temperature: ± 0.2° F (± 0.1° C).
 Pressure: 0.05% of full scale.
 Density: 0.1% of reading.

Stability Over 12 Months

Mass Flow Rate: 0.2% of rate maximum.
 Volumetric Flow Rate: Negligible error.
 Temperature: ± 0.1° F (± 0.5° C) maximum.
 Pressure: 0.1% of full scale maximum.
 Density: 0.1% of reading maximum.

Response Time

Adjustable from 1 to 100 seconds.

Material Capability

Series 240 In-Line Flow Meter:
 Any gas, liquid or steam compatible with 316L stainless steel, C276 hastelloy or A105 carbon steel. Not recommended for multi-phase fluids.

Series 241 Insertion Flow Meter:
 Any gas, liquid or steam compatible with 316L stainless steel. Not recommended for multi-phase fluids.

Flow Rates

Typical mass flow ranges are given in the following table. Precise flow depends on the fluid and pipe size. 241 insertion meters are applicable to pipe sizes from 2 inch and above. Consult factory for sizing program.

Water Minimum and Maximum Flow Rates									
	½-inch	¾-inch	1-inch	1.5-inch	2-inch	3-inch	4-inch	6-inch	8-inch
gpm	1	1.3	2.2	5.5	9.2	21	36	81	142
	22	40	67	166	276	618	1076	2437	4270
m ³ /hr	.23	.3	0.5	1.3	2.1	4.7	8.1	18	32
	5	9.1	15	38	63	140	244	554	970

Typical Air Minimum and Maximum Flow Rates (SCFM)									
Air at 70°F									
Nominal Pipe Size (in)									
Pressure	0.5	0.75	1	1.5	2	3	4	6	8
0 psig	1.8	3	5	13	22	50	87	198	347
	18	41	90	221	369	826	1437	3258	5708
100 psig	5	9	15	38	63	141	245	555	972
	138	325	704	1730	2890	6466	11254	25515	44698
200 psig	7	13	21	52	86	193	335	761	1332
	258	609	1322	3248	5427	12140	21131	47911	83931
300 psig	8	15	25	63	104	234	407	922	1615
	380	896	1944	4775	7978	17847	31064	70431	123375
400 psig	10	18	29	72	120	269	467	1060	1857
	502	1183	2568	6309	10542	23580	41043	93057	163000
500 psig	11	20	33	80	134	300	521	1182	2071
	624	1472	3195	7849	13115	28034	51063	115775	203000

Typical Air Minimum and Maximum Flow Rates (nm ³ /hr)									
Air at 20°C									
Nominal Pipe Size (mm)									
Pressure	15	20	25	40	50	80	100	150	200
0 barg	3	5	9	21	36	79	138	313	549
	28	66	142	350	584	1307	2275	5157	9034
5 barg	7	13	21	52	87	194	337	764	1339
	165	390	847	2080	3476	7775	13533	30682	53749
10 barg	9	17	29	70	117	262	457	1035	1814
	304	716	1554	3819	6381	14273	24844	56329	98676
15 barg	11	21	34	85	142	317	551	1250	2190
	442	1044	2265	5565	9299	20801	36205	82087	143801
20 barg	13	24	40	97	162	363	632	1434	2511
	582	1373	2979	7318	12229	27354	47612	107949	189105
30 barg	16	29	48	118	198	442	770	1745	3057
	862	2034	4414	10843	18119	40529	70544	159942	280187

Linear Range Smart electronics corrects for lower flow down to a Reynolds number of 5,000. The Reynolds number is calculated using the fluid's actual temperature and pressure monitored by the meter. Rangeability depends on the fluid, process connections and pipe size. Consult factory for your application. Velocity rangeability under ideal conditions is as follows:

Liquids 30:1 1 foot per second velocity minimum
 30 feet per second velocity maximum

Gases 30:1 10 feet per second velocity minimum
 300 feet per second velocity maximum

Typical Saturated Steam Minimum and Maximum Flow Rates (lb/hr)									
	Nominal Pipe Size (in)								
Pressure	0.5	0.75	1	1.5	2	3	4	6	8
5 psig	6.5	12	20	49	82	183	318	722	1264
	52	122	265	650	1087	2431	4231	9594	16806
100 psig	15	27	46	112	187	419	728	1652	2893
	271	639	1386	3405	5690	12729	22156	50233	87998
200 psig	20	37	62	151	253	565	983	2229	3905
	493	1163	2525	6203	10365	23184	40354	91494	160279
300 psig	24	45	74	182	304	680	1184	2685	4704
	716	1688	3664	9000	15040	33642	58556	132763	232575
400 psig	28	51	85	209	349	780	1358	3079	5393
	941	2220	4816	11831	19770	44222	76971	174516	305717
500 psig	31	57	95	233	389	870	1514	3433	6014
	1170	2760	5988	14711	24582	54987	95710	217001	380148

Typical Saturated Steam Minimum and Maximum Flow Rates (kg/hr)									
	Nominal Pipe Size (mm)								
Pressure	0.5	0.75	1	1.5	2	3	4	6	8
0 barg	3	5	8	19	32	72	126	286	500
	18	42	91	224	375	838	1459	3309	5797
5 barg	6	11	18	45	75	167	290	658	1153
	95	224	485	1192	1992	4455	7754	17581	30799
10 barg	8	15	24	59	99	222	387	877	1537
	168	397	862	2118	3539	7915	13777	31237	54720
15 barg	9	17	29	71	119	266	463	1050	1840
	241	569	1236	3036	5073	11347	19750	44779	78444
20 barg	11	20	33	81	136	304	529	1199	2100
	314	742	1610	3956	6611	14787	25738	58355	102226
30 barg	13	24	40	99	165	369	642	1455	2548
	463	1092	2370	5822	9729	21763	37880	85884	150451

Linear Range

Smart electronics corrects for lower flow down to a Reynolds number of 5,000. The Reynolds number is calculated using the fluid's actual temperature and pressure monitored by the meter. Rangeability depends on the fluid, process connections and pipe size. Consult factory for your application. Velocity rangeability under ideal conditions is as follows:

Liquids 30:1

1 foot per second velocity minimum
30 feet per second velocity maximum

Gases 30:1

10 feet per second velocity minimum
300 feet per second velocity maximum

Process Fluid Pressure

240 Pressure Ratings		
Process Connection	Material	Rating
Flanged	316L SS, A105 Carbon Steel, C276 Hastelloy	150, 300, 600 lb, PN16, PN40, PN64
Wafer	316L SS, A105 Carbon Steel, C276 Hastelloy	600 lb, PN64

241 Pressure Ratings				
Probe Seal	Process Connection	Material	Rating	Ordering Code
Compression Fitting	2-inch MNPT	316L SS	ANSI 600 lb	CNPT
	2-inch 150 lb flange, DN50 PN16	316L SS	ANSI 150 lb, PN16	C150, C16
	2-inch 300 lb flange, DN50 PN40	316L SS	ANSI 300 lb, PN40	C300, C40
	2-inch 600 lb flange, DN50 PN64	316L SS	ANSI 600 lb, PN64	C600, C64
Packing Gland	2-inch MNPT	316L SS	50 psig	PNPT
	2-inch 150 lb flange, DN50 PN16	316L SS	50 psig	P150, P16
	2-inch 300 lb flange, DN50 PN40	316L SS	50 psig	P300, P40
Packing Gland with Removable Retractor	2-inch MNPT	316L SS	ANSI 300 lb	PM, RR
	2-inch 150 lb flange, DN50, PN16	316L SS	ANSI 150 lb	P150, P16,RR
	2-inch 300 lb flange	316L SS	ANSI 300 lb	P300, P40, RR
Packing Gland with Permanent Retractor	2-inch MNPT	316L SS	ANSI 600 lb	PNPTR
	2-inch 150 lb flange, DN50 PN16	316L SS	ANSI 150 lb	P150R, P16R
	2-inch 300 lb flange, DN50, PN40	316L SS	ANSI 300 lb	P300R, P40R
	2-inch 600 lb flange, DN50 PN64	316L SS	ANSI 600 lb	P600R, P64R

Pressure Transducer Ranges

Pressure Sensor Ranges ⁽¹⁾ , psia (bara)			
Full Scale Operating Pressure		Maximum Over-Range Pressure	
psia	(bara)	psia	(bara)
30	2	60	4
100	7	200	14
300	20	600	40
500	35	1000	70
1500	100	2500	175

Note: (1) To maximize accuracy, specify the lowest full scale operating pressure range for the application. To avoid damage, the flow meter must never be subjected to pressure above the over-range pressure shown above.

Power Requirements

12 to 36 VDC, Loop Powered for the Volumetric option only
 12 to 36 VDC, 100 mA for the Multiparameter Mass options
 100 to 240 VAC, 50/60 Hz, 25 watts for the Multiparameter Mass options

Display

Alphanumeric 2 x 16 LCD digital display.
 Six push-button switches (up, down, right, left, enter, exit) operable through explosion-proof window using hand-held magnet. Viewing at 90-degree mounting intervals.

Process Fluid and Ambient Temperature	<p><u>Process Fluid:</u> Standard temperature sensor: -40° F to 500° F (-40° C to 260° C). High temperature sensor: to 750° F (to 400° C).</p> <p><u>Ambient:</u> Operating: -5° F to 140° F (-20° C to 60° C). Storage: -40° F to 150° F (-40° C to 65° C). 0-98% relative humidity, non-condensing conditions.</p>
Output Signals ⁽¹⁾	<p>Analog: Volumetric Meter: field rangeable linear 4-20 mA output signal (1000 Ohms maximum loop resistance) selected by user for mass flow rate or volumetric flow rate.</p> <p>Communications: HART, MODBUS, RS485</p> <p>Multiparameter Meter: up to three field rangeable linear 4-20 mA output signals (1000 Ohms maximum loop resistance) selected from the five parameters—mass flow rate, volumetric flow rate, temperature, pressure and density.</p> <p>Pulse:Pulse output for totalization is a 50-millisecond duration pulse operating a solid-state relay capable of switching 40 VDC, 40 mA maximum.</p> <p>Note: (1) All outputs are optically isolated and require external power for operation.</p>
Alarms	Up to three programmable solid-state relays for high, low or window alarms capable of switching 40 VDC, 40 mA maximum.
Totalizer	Based on user-determined flow units, six significant figures in scientific notation. Total stored in non-volatile memory.
Wetted Materials	<p>Series 240 In-Line Flow Meter: 316L stainless steel standard. C276 hastelloy or A105 carbon steel optional.</p> <p>Series 241 Insertion Flow Meter: 316L stainless steel standard. Teflon[®] packing gland below 500° F (260° C). Graphite packing gland above 500° F (260° C).</p>
Enclosure	NEMA 4X cast enclosure.
Electrical Ports	Two 3/4-inch female NPT ports.
Mounting Connections	<p>Series 240: Wafer, 150, 300, 600 lb ANSI flange, PN16, PN40, PN64 flange.</p> <p>Series 241 Permanent installation: 2-inch MNPT; 150, 300, 600 lb ANSI flange, PN16, PN40, PN64 flange with compression fitting probe seal.</p> <p>Series 241 Hot Tap⁽¹⁾ Installation: 2-inch MNPT; 150, 300, 600 lb ANSI flange, PN16, PN40, PN64 flange and optional retractor with packing gland probe seal.</p> <p>Note: (1) Removable under line pressure.</p>
Mounting Position	<p>Series 240 In-Line Flow Meter: No effect.</p> <p>Series 241 Insertion Flow Meter: Meter must be perpendicular within $\pm 5^\circ$ of the pipe centerline.</p>
Certifications	<p>Construction Inspection (ANSI/ASME B31.3). Materials (NACE MR-01-75[90]). CE and FM approved. CSA, CENELEC approval pending.</p> <p>FM approvals: Class I, Division 1, Groups B, C, & D, T6 at Tamb = 60°C Class II/III, Division 1, Groups E, F, & G IP66, NEMA 4X</p>

Er Appendix B Glossary

A B C D

A	Cross sectional area.
ACFM	Actual Cubic Feet Per Minute (volumetric flow rate).
ASME	American Society of Mechanical Engineers.
Bluff Body	A non-streamlined body placed into a flow stream to create vortices. Also called a Shedder Bar.
BTU	British Thermal Unit, an energy measurement.
Cenelec	European Electrical Code.
Compressibility Factor	A factor used to correct for the non-ideal changes in a fluid's density due to changes in temperature and/or pressure.
CSA	Canadian Standards Association.
d	Width of a bluff body or shedder bar.
D	Diameter of a flow channel.

E F G H

f	Frequency of vortices generated in a vortex flow meter, usually in Hz.
Flow Channel	A pipe, duct, stack, or channel containing flowing fluid.
Flow Profile	A map of the fluid velocity vector (usually non-uniform) in a cross-sectional plane of a flow channel (usually along a diameter).
FM	Factory Mutual.
Ft	Foot, 12 inches, a measure of length.
Ft ²	Square feet, measure of area.
Ft ³	Cubic feet, measure of volume.
GPM	Gallons Per Minute.
Hz	Hertz, cycles per second.

I J K L

In-Line Flow Meter	A flow meter which includes a short section of piping which is put in-line with the user's piping.
Insertion Flow Meter	A flow meter which is inserted into a hole in the user's pipeline.
Joule	A unit of energy equal to one watt for one second. Also equal to a Newton-meter.
LCD	Liquid crystal display.

M N O P

\dot{m}	Mass flow rate.
mA	Milli-amp, one thousandth of an ampere of current.
μ	Viscosity, a measure of a fluid's resistance to shear stress. Honey has high viscosity, alcohol has low viscosity.
ΔP	Permanent pressure loss.
P	Line pressure (psia or bar absolute).
ρ_{act}	The density of a fluid at the <u>actual</u> temperature and pressure operating conditions.
ρ_{std}	The density of a fluid at <u>standard</u> conditions (usually 14.7 psia and 20° C).
Permanent Pressure Loss	Unrecoverable drop in pressure.
Piezoelectric Crystal	A material which generates an electrical charge when the material is put under stress.
PRTD	An resistance temperature detector (RTD) with platinum as its element. Used because of high stability.
psia	Pounds per square inch absolute (equals psig + atmospheric pressure). Atmospheric pressure is typically 14.696 psi at sea level.
psig	Pounds per square inch gauge.
P_V	Liquid vapor pressure at flowing conditions (psia or bar absolute).

Q R S T

Q	Flow rate, usually volumetric.
Rangeability	Highest measurable flow rate divided by the lowest measurable flow rate.
Reynolds Number or Re	A dimensionless number equal to the density of a fluid times the velocity of the fluid times the diameter of the fluid channel, divided by the fluid viscosity (i.e., $Re = \rho VD/\mu$). The Reynolds number is an important number for vortex flow meters because it is used to determine the minimum measurable flow rate. It is the ratio of the inertial forces to the viscous forces in a flowing fluid.
RTD	Resistance temperature detector, a sensor whose resistance increases as the temperature rises.
scfm	Standard cubic feet per minute (flow rate converted to standard conditions, usually 14.7 psia and 20° C).
Shedder Bar	A non-streamlined body placed into a flow stream to create vortices. Also called a Bluff Body.
Strouhal Number or St	A dimensionless number equal to the frequency of vortices created by a bluff body times the width of the bluff body divided by the velocity of the flowing fluid (i.e., $St = fd/V$). This is an important number for vortex flow meters because it relates the vortex frequency to the fluid velocity.
Totalizer	An electronic counter which records the total accumulated flow over a certain range of time.
Traverse	The act of moving a measuring point across the width of a flow channel.

U V W X Y Z

Uncertainty	The closeness of agreement between the result of a measurement and the true value of the measurement.
V	Velocity or voltage.
VAC	Volts, alternating current.
VDC	Volts, direct current.
VORTEX	An eddy of fluid.

Appendix C Fluid Calculations

Calculations for Steam T & P

When “Steam T & P” is selected in the “Real Gas” selection of the Fluid Menu, the calculations are based on the equations below.

Density

The density of steam is calculated from the formula given by Keenan and Keys. The given equation is for the volume of the steam.

$$v = \frac{4.555.04 \cdot T}{p} + B$$

$$B = B_0 + B_0^2 g_1(\tau) \tau \cdot p + B_0^4 g_2(\tau) \tau^3 \cdot p^3 - B_0^{13} g_3(\tau) \tau^{12} \cdot p^{12}$$

$$B_0 = 1.89 - 2641.62 \cdot \tau \cdot 10^{80870\tau^2}$$

$$g_1(\tau) = 82.546 \cdot \tau - 1.6246 \cdot 10^5 \cdot \tau^2$$

$$g_2(\tau) = 0.21828 - 1.2697 \cdot 10^5 \cdot \tau^2$$

$$g_3(\tau) = 3.635 \cdot 10^{-4} - 6.768 \cdot 10^{64} \cdot \tau^{24}$$

Where tau is 1/ temperature in Kelvin.

The density can be found from 1/(v/ standard density of water).

Viscosity

The viscosity is based on an equation given by Keenan and Keys.

$$\eta(\text{poise}) = \frac{1.501 \cdot 10^{-5} \sqrt{T}}{1 + 446.8/T}$$

Where T is the temperature in Kelvin

Calculations for Gas ("Real Gas" and "Other Gas")

Use this formula to determine the settings for "Real Gas; Gas" selections and "Other Gas" selections entered in the Fluid Menu. The calculations for gas were taken from Richard W. Miller, *Flow Measurement Engineering Handbook (Second Edition, 1989)*.

Density

The density for real gases is calculated from the equation:

$$\rho = \frac{GM_{w,Air}P_f}{Z_f R_0 T_f}$$

Where G is the specific gravity, M_w is the molecular weight of air, p_f is the flowing pressure, Z is flowing compressibility, R_0 is the universal gas constant, and T is the flowing temperature.

The specific gravity, and R_0 are known and are stored in a table used by the Vortex meter.

The hard coefficient to find is the compressibility, Z. Z is found using the Redlich-Kwong Equation (Miller page 2-18).

The Redlich-Kwong Equation uses the reduced temperature and pressure to calculate the compressibility factor. The equations are non linear and an iterative solution is used. The Vortex program uses Newton's Method on the Redlich-Kwong equations to iteratively find the compressibility factor. The critical temperature and pressure used in the Redlich-Kwong equation are stored in the fluid data table with the other coefficients.

Viscosity

The viscosity for real gases is calculated using the exponential equation for two known viscosities. The equation is:

$$\mu_{cP} = aT_K^n$$

Where a and n are found from two known viscosities at two temperatures.

$$n = \frac{\ln[(\mu_{cP})_2 / (\mu_{cP})_1]}{\ln(T_{K2} / T_{K1})}$$

and

$$a = \frac{(\mu_{cP})_1}{T_{K1}^n}$$

Calculations for Liquid

Use this formula to determine the settings for “Goyal-Dorais” selections and “Other Liquid” selections entered in the Fluid Menu. The liquid calculations were taken from Richard W. Miller, *Flow Measurement Engineering Handbook (Second Edition, 1989)*.

Density

The liquid density is found using the Goyal-Doraiswamy Equation. Goyal-Doraiswamy uses the critical compressibility, critical pressure and critical temperature, along with the molecular weight to find the density. The equation for specific gravity is:

$$G_F = \frac{p_c Mw}{T_c} \left(\frac{0.008}{Z_c^{0.773}} - 0.01102 \frac{T_f}{T_c} \right)$$

The specific gravity can then be converted into density.

Viscosity

The liquid viscosity is found by Andrade's equation. This uses two viscosities at different temperatures to extrapolate the viscosity.

Andrade's equation:

$$\mu = A_L \exp \frac{B_L}{T_{\text{deg}R}}$$

To find A and B

$$B_L = \frac{T_{\text{deg}R1} T_{\text{deg}R2} \ln(\mu_1 / \mu_2)}{T_{\text{deg}R2} - T_{\text{deg}R1}}$$

$$A_L = \frac{\mu_1}{\exp(B_L / T_{\text{deg}R1})}$$

The temperatures are all in degrees Rankin. Do not believe the subscript R means they are reduced temperatures.

Appendix D HART Commands with DD Menu

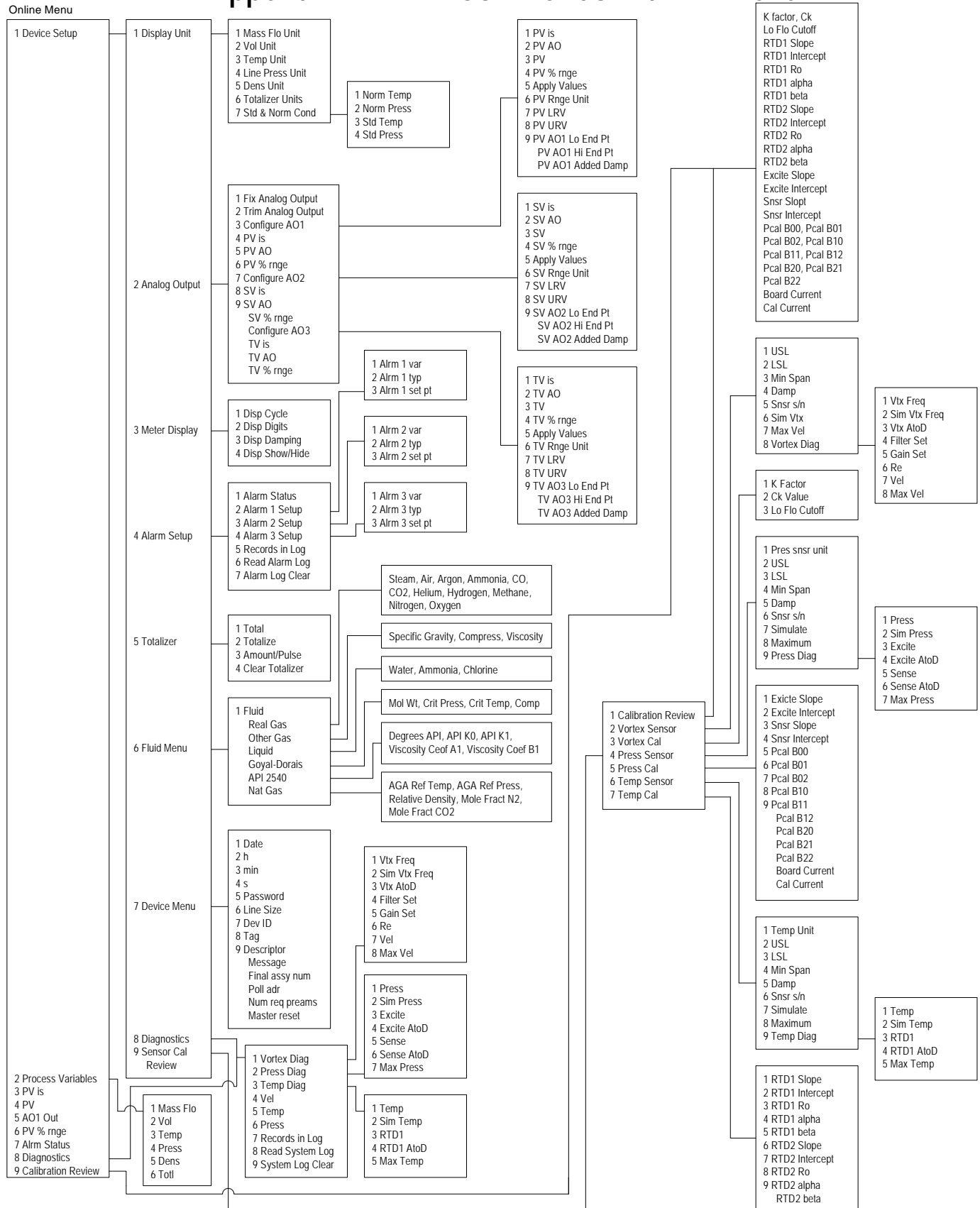

Appendix D HART Commands without DD Menu

