

# Appendix for ATEX and IECEx Certified EX Units Instruction Manual



QuadraTherm® 640i and 780i Mass Flow  
Meters Certified ATEX and IECEx

Part Number: IM-QuadraTherm-ATEX and IECEx Rev G  
October 2024

## **GLOBAL SUPPORT LOCATIONS: WE ARE HERE TO HELP!**

**For Global Service Centers, go to <http://www.sierrainstruments.com/facilities.html>**

### **CORPORATE HEADQUARTERS**

20 Ryan Ranch Road, Suite 109  
Monterey, CA 93940  
Phone (831) 373-0200  
[info@sierrainstruments.com](mailto:info@sierrainstruments.com)  
[www.sierrainstruments.com](http://www.sierrainstruments.com)

### **EMEA HEADQUARTERS**

Bijlmansweid 2 1934RE Egmond aan den Hoef  
The Netherlands  
Phone +31 72 5071400  
[sales@sierrainstruments.nl](mailto:sales@sierrainstruments.nl)

### **ASIA HEADQUARTERS**

Second Floor Building 5, Senpu Industrial Park  
25 Hangdu Road Hangtou Town  
Pu Dong New District, Shanghai, P.R. China  
Postal Code 201316  
Phone: + 8621 5879 8521

### **IMPORTANT CUSTOMER NOTICE- OXYGEN SERVICE**

Sierra Instruments, Inc. is not liable for any damage or personal injury, whatsoever, resulting from the use of Sierra Instruments standard mass flow meters for oxygen gas. You are responsible for determining if this mass flow meter is appropriate for your oxygen application. You are responsible for cleaning the mass flow meter to the degree required for your oxygen flow application.

### **© COPYRIGHT SIERRA INSTRUMENTS 2024**

No part of this publication may be copied or distributed, transmitted, transcribed, stored in a retrieval system, or translated into any human or computer language, in any form or by any means, electronic, mechanical, manual, or otherwise, or disclosed to third parties without the express written permission of Sierra Instruments. The information contained in this manual is subject to change without notice.

### **TRADEMARKS**

QuadraTherm® is a trademark of Sierra Instruments, Inc. Other product and company names listed in this manual are trademarks or trade names of their respective manufacturers.

**Initial Release:** clarify instructions for ATEX and IEC-Ex on 640i/780i Quadratherm product line

## Contents

<b>1. Labeling</b> .....	4
<b>2. Type Approval Standards</b> .....	5
<b>3. Zone, Gas Group, Category and Temperature class</b> .....	5
3.1. Area Classification.....	5
3.2. Gas Grouping.....	6
3.3. Equipment Category.....	6
3.4. Temperature Classification.....	6
3.5. Ambient Temperature Range .....	6
<b>4. Safe Use of ATEX and IECEx Approved Equipment</b> .....	6
4.1. Notes on Safe Use of the ATEX Approved Equipment.....	6
4.2. Mounting, Commissioning, and Operation .....	6
4.3. Explosive Hazardous Area .....	7
4.4. Special Conditions for a Safe Use.....	7
4.5. Particular Recommendations: Closing the Cover .....	7
<b>5. Remote Electronics</b> .....	8
<b>6. Maintenance</b> .....	9
6.1. External Maintenance.....	9
6.2. Sensor Maintenance .....	9
6.3. Internal Maintenance.....	9
<b>7. Earthing</b> .....	9
7.1. External Earthing.....	10
7.2. Internal Earthing.....	10
<b>8. Warning</b> .....	10
<b>9. Returning Equipment to Factory</b> .....	10
 Addendum A: Installation Instructions Cable Gland.....	 12
 Addendum B: Agency Approvals .....	 16

This is a certified ATEX document. Changes must be approved by the  
Sierra ATEX Authorized Personnel

# 1. Labeling

Sierra Instruments Model 640i and 780i ATEX and IECEx Flow Transmitters that have the following label attached have been certified in compliance with  
 ATEX: EN/IEC 60079-0:2018, EN 60079-1:2014, EN 60079-31: 2014  
 IECEx: IEC 60079-0:2017, IEC 60079-1: 2014, IEC 60079-31: 2022



## ATEX and IECEx label, Enclosure Back, 640i/780i

The following information is provided as part of the labeling of the transmitter:

- Name and website of the manufacturer: Sierra Instruments, [www.sierrainstruments.com](http://www.sierrainstruments.com)
- The Model number, serial number and order number of the device
- Input power and maximum temperature and pressure
- Manufacturing date
- CE Mark
- ATEX/IECEx marking:

II 2 G Ex db IIC T3 Gb  
 II 2 D Ex tb IIIC T200°C Db

- ATEX/IECEX Ambient temperature range  $T_a = -20^{\circ}\text{C}$  to  $+60^{\circ}\text{C}$
- ATEX certificate number: FM13ATEX0082X; IECEx certificate number: IECEx FMG 13.0031X
- Process temperature range:  $-40^{\circ}\text{C}$  to  $+200^{\circ}\text{C}$
- IP 66 housing rating
- The following warnings should be obeyed:

WARNING: DO NOT OPEN WHEN AN EXPLOSIVE ATMOSPHERE IS PRESENT

WARNING: DO NOT OPEN WHEN ENERGIZED

WARNING: POTENTIAL ELECTROSTATIC CHARGING HAZARD—SEE INSTRUCTIONS

## 2. Type Approval Standards

The Sierra Instruments ATEX/IECEX approved flow meters have an EC Type examination certificate issued by FM Approvals and have been approved to the following standards:

ATEX: EN/IEC 60079-0:2018, EN 60079-1: 2014, EN 60079-31: 2014

IECEX: IEC 60079-0:2017, IEC 60079-1: 2014, IEC 60079-31: 2022

## 3. Zone, Gas Group, Category and Temperature class

The Sierra Instruments 640i/780i ATEX and IECEx units have been certified ATEX/IECEX marking:

II 2 G Ex db IIC T3 Gb

II 2 D Ex tb IIIC T200°C Db

This means that the units can be installed in locations with the following conditions.

### 3.1. Area Classification

Zone 1	Area in which an explosive gas atmosphere is likely to occur in normal operation occasionally
Zone 2	Area in which an explosive gas atmosphere is not likely to occur in normal operation and if it does occur, is likely to do so only infrequently and will exist for a short period only
Zone 21	Place in which an explosive atmosphere in the form of a cloud of combustible dust in air is likely to occur in normal operation occasionally
Zone 22	Place in which an explosive atmosphere in the form of a cloud of combustible dust in air is not likely to occur in normal operation but, if it does, will persist for a short period only

### 3.2. Gas Grouping

Group IIA	Propane
Group IIB	Ethylene
Group IIC	Hydrogen and Acetylene

### 3.3. Equipment Category

2GD (Zone 2 suitable for Gasses and Dust explosive environments)

### 3.4. Temperature Classification for ATEX

Temperature Class	Maximum Process temperature (°C)	Maximum Surface Temperature (°C)
T6	40	70
T5	50	80
T4	85	115
T3	150	180
T2	250	280

### 3.5. Ambient Temperature Range

Ambient temperature range -20°C to +60°C

## 4. Safe Use of ATEX Approved Equipment

### 4.1. Notes on Safe Use of the ATEX Approved Equipment

Approved usage of the meter is restricted to fluids compatible with the wetted materials of the flow meter and within the restrictions on temperature and pressure as defined in the product manual.

### 4.2. Mounting, Commissioning, and Operation

The device has been designed to operate safely in accordance with the current technical and safety regulations of the EU. If installed incorrectly or used for applications for which it is not intended, it is possible that application related changes may arise. For this reason, the instrument must be installed, connected, operated, and maintained according to the instructions in this and the specific product operating manual.

Persons handling/installing or commissioning this equipment must be authorized and suitably qualified. The manual must be read, understood, and the instructions must be followed. Modifications and repairs to the device are only permissible when they are expressly approved in this manual.

### 4.3. **Explosive Hazardous Area**

If the device is to be installed in an explosive hazardous area, then the specifications in the certificate as well as all national and local regulations must be observed.

The instrument will be delivered with the certified ATEX/IECEx marking :

II 2 G Ex db IIC T3 Gb

II 2 D Ex tb IIIC T200°C Db

The certificate type can be identified from the second group of numbers (Feature 2: Approvals) on the model code stamped on the nameplate. For example:

1= NAA : Not suitable for hazardous areas, Non-Agency Approved.

2= cFMus : Explosion proof for Class I, Division 1, Groups B, C, D

3= ATEX/IECEx: II 2 G Ex db IIC T3 Gb/II 2 D Ex tb IIIC T200°C Db

This manual addition only applies to ATEX/IECEx units: II 2 G Ex db IIC T3 Gb or IECEx II 2 D Ex tb IIIC T200°C Db

The unit is supplied without cable glands for the power and signal. It is the user's responsibility to select suitable cable glands that meet or exceed the required ATEX/IECEx approval and that are suitable for the signal and power cable used. The connections on the electronics housing for the input power and signal cable glands is 3/4"-14 female NPT threads according to the NPT requirements of ANSI B1.20.1 plus +0.5 to +2.0 turns deeper.

**WARNING:** UNUSED WIRING ENTRIES ARE TO BE CLOSED USING SUITABLY CERTIFIED PLUGS TO MAINTAIN THE ENCLOSURE TYPE OF PROTECTION

**NOTE:** Please insure that when you mount these cable glands they are made-up wrench tight. At least 3-1/2 turns of the thread must be engaged inside of the electronics enclosure.

### 4.4. **Special Conditions for a Safe Use**

The ambient temperature must never overrun the following limits: -20...+60°C. The surface temperature of the device (indicated on the device) must never exceed this temperature and must take into account both ambient and fluid temperatures.

The flame proof joints are not intended to be repaired. Consult the manufacturer for additional information.

A suitably certified conduit sealing device is required within 13 inches of the enclosure for probes longer than 13 inches.

### 4.5. **Particular Recommendations: Closing the Cover**

The safety is guaranteed as long as the covers are correctly screwed and locked.

The lid locking screws are #10-24 Socket Head Cap Screws (SHC Screw) that use a 5/32-inch hex head wrench/driver to adjust. To lock the lids firmly tighten down/secure the lid and then back out the associated SHC screw firmly so that the lid is secured and locked in place. If one of the ribs/bumps on the lid happens to line up so it is blocking access to the SHC screw then

either slightly tighten the lid more or loosen the lid slightly, just enough to gain access to the lid locking SHC screw. *Note that this very minor adjustment, if necessary, does not affect the leak integrity of the enclosure.* To un-lock the lid allowing for removal, just turn in the associated SHC screw so that it is no longer in contact with the lid, then the lid can be removed. There are two lids to be locked on the main (or remote E4 VTP if feature was ordered) enclosure and one lid to be locked on the remote enclosure (If E4VT feature was ordered) in order to maintain the safety ratings.”

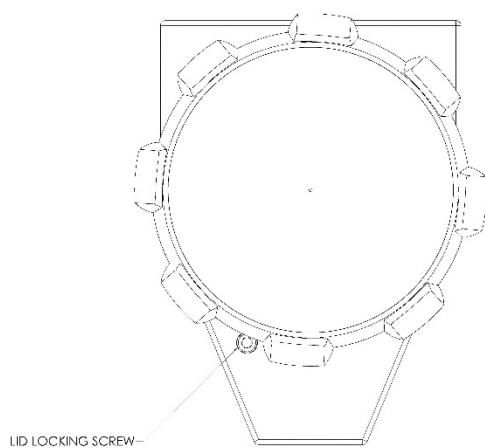

QuadraTherm Main and Remote E4 VTP Enclosure Shown With Lid Locking Screw

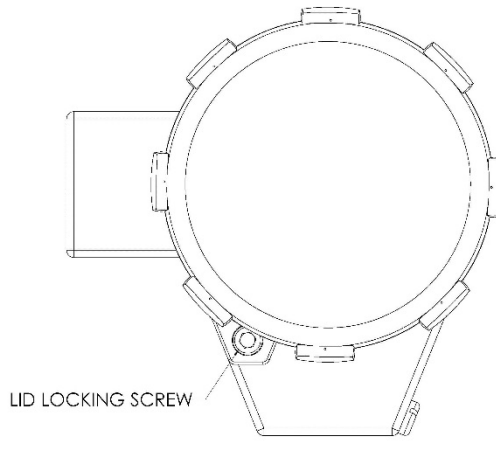

QuadraTherm E4 VT Remote Enclosure Shown with Lid Locking Screw

The following warnings should be obeyed:

WARNING: DO NOT OPEN WHEN AN EXPLOSIVE ATMOSPHERE IS PRESENT

WARNING: DO NOT OPEN WHEN ENERGIZED

WARNING: POTENTIAL ELECTROSTATIC CHARGING HAZARD—SEE INSTRUCTIONS

To minimize an electrostatic charging hazard on the exterior of the enclosures both the main and remote (if ordered) enclosures should be connected to earth ground, see section 7 below for more details.

## 5. Remote Electronics

Sierra Thermal flow transmitters with E4 in the model code have remote electronics. They have a cable with glands between the sensor and the electronics. These VT units are marked as follows (or the same as the main enclosure for E4 VTP):



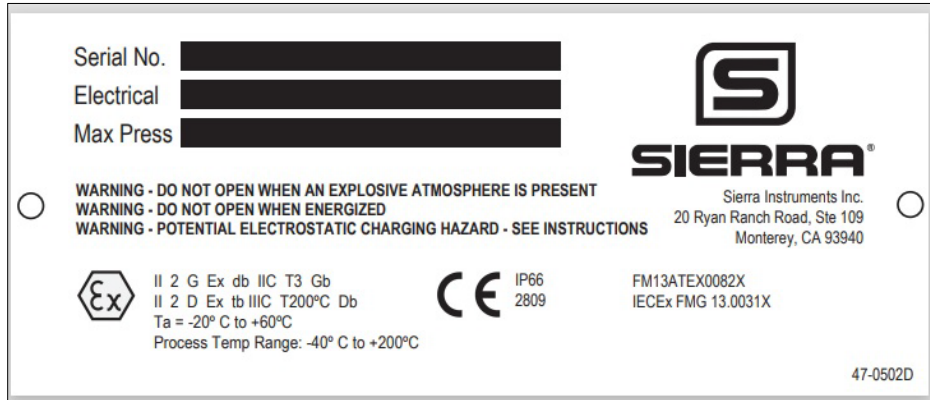

Sierra 640i/780i Remote Label

**Please see the previous sections for explanations of all labeling requirements**

If the remote wires need to be disconnected refer to the remote sensor wiring section of the instruction manual.

## 6. Maintenance

### 6.1. External Maintenance

The Sierra flow meters can be externally maintained with a dry clean cloth.

### 6.2. Sensor Maintenance

The sensor can be maintained by switching off the power, removing the probe from the process and cleaning the probe with a solvent compatible with 316SS. After cleaning the probe clean and dry the sensor with compressed air before you insert it back it the process. It is not recommended to use any Ultrasonic Bath cleaning.

### 6.3. Internal Maintenance

Please make sure that the internals of the unit always stay dry and clean. There are no user maintainable components inside the electronic compartment.

## 7. Earthing

The Sierra Instruments units must be connected to a good quality earth. The units are provided with internal and external earthing terminals.

### **7.1. External Earthing**

The external earthing connections are located on the boss on the outside of both the main housing and remote housing (E4 option if ordered) and consist of an 18-8SS pan head Phillips screw (10-24 UNC-2B thread) and a serrated tooth #10 ring terminal for 16-14 AWG wire.

### **7.2. Internal Earthing**

The internal earthing connection is located in the main housing terminal side and consist of an 18-8SS pan head Phillips screw (10-24 UNC-2B thread) and a serrated tooth #10 ring terminal for 16-14 AWG wire.

## **8. Warning**

The electronics for ATEX and IECEx units contain special dedicated electronics. No customer modifications are available and are strictly forbidden. Any modification or adjustment to the electronics can be performed at the factory only.

## **9. Returning Equipment to Factory**

### ***Factory Calibration—All Models***

Sierra Instruments maintains a fully-equipped calibration laboratory. All measuring and test equipment used in the calibration of Sierra transducers are traceable to NIST Standards. Sierra is ISO-9001 registered and conforms to the requirements of ANSI/NCSL-Z540 and ISO/IEC Guide 25.

### ***Instructions for Returning Your Instrument for Service***

The following information will help you return your instrument to Sierra Instruments' Factory Service Center and will ensure that your order is processed promptly. Prices may vary depending on the flow range, type of gas and operating pressure of your unit. To request detailed pricing, contact your local Sierra Instruments distributor or contact one of our offices directly.

### ***Please follow these easy steps to return your instrument for factory service:***

1. To obtain a Return Materials Authorization (RMA) number from the Sierra Instruments to <http://www.sierrainstruments.com/rma/new.php> to create a Sierra Account.
2. Once you have created an account, click on the *Submit New RMA* tab and fill in the RMA form and follow the instructions. You will receive an email confirmation once you have submitted your RMA.
3. Print a copy of the RMA (that now includes RMA #) and send a copy of the RMA form along with your meter back to the factory.
4. If you require service beyond calibration, but do not know which service(s) will be required, describe the symptoms as accurately as possible on the RMA form.

5. Pack your instrument carefully. Use the original packaging and foam or bubble wrap (packing peanuts NOT recommended) and include a copy of the RMA form (complete with Sierra supplied RMA number) with the unit(s).

Ship the unit(s) to the following address:

**Sierra Instruments, Inc.  
Attention: Factory Service Center  
20 Ryan Ranch Road, Suite 109  
Monterey, CA 93940 USA  
RE: RMA# (your number)**

## **Addendum A: Installation Instructions Cable Gland**

### **Manufacturer:**

Sealcon (Hummel)  
7374 S. Eagle Street  
Centennial, CO 80112-4221  
USA

Cable Glands used on Sierra E4 units:

Sealcon: CD13NR-BE-N-ASMBLD PK=10 (Sierra Reference 30-0647)

### **Brief Description:**

The Sealcon (Hummel) type cable gland is for use in the appropriate Hazardous Areas with braided shield cable. It gives environmental protection to IP66. This cable gland is an EMI/RFI proof Nickel Plated Brass type. A termination suitable for EMI/RFI protection is made using braided shield cables with these glands. These glands are non-corrosive and are resistant to salt water, weak acids, weak alkalis, alcohol, esters, ketones, ether, gasoline, mineral, animal & vegetable oil. RoHS and Deca BDE compliant.

### **Warning:**

**PLEASE STUDY CAREFULLY ALL PAGES OF THESE INSTRUCTIONS BEFORE INSTALLATION.**

These glands should not be used in any application other than those mentioned here or in our Data Sheets, unless Sealcon (Hummel) states in writing that the product is suitable for such application. Sealcon (Hummel) can take no responsibility for any damage, injury or other consequential loss caused where the glands are not installed or used according to these instructions. This leaflet is not intended to advice on the selection of cable glands.

PART NUMBERS	DIMENSIONS INCHES (MM)								
	Standard		Cable Range Inches (mm)	A Cable Range Inches (mm)	B Body Length Inches (mm)	C Body Length Inches (mm)	D Inlet Length Inches (mm)	E/E Welding Size Inches (mm)	
	Dome Fittings	Flex Fittings							U.S. Fittings
CD27AA-3L CD27AE-E	C 07AA-E C 07AE-E	CD27AA-L	1.1 - 26.15-26 08 - 2312-25	30.7 NPT-PT	18.12	75.0	31.24	2.64(65)	20.56 85.14
CD28AA-3L CD28AE-E	C 08AA-E C 08AE-E	CD28AA-L	16 - 31.6 - 25 08 - 2112-23	70 P	30.15	82.24	1.12(28)	2.69(68)	21.56 87.17
CD29AA-3L CD29AE-E	C 09AA-E C 09AE-E	CD29AA-L	16 - 31.6 - 25 08 - 2112-23	38 NPT	30.17	82.24	1.12(28)	2.69(68)	21.56 87.17
CD 1AA-3L CD 1AE-E	C 1 AA-E C 1 AE-E	CD 1AA-L	20 - 29.15-16 11 - 2212-15	PG-11	75.18	87.22	1.12(28)	3.03(77)	24.06 76.20
CD 3AA-3E CD 3AE-E	C 3AA-E C 3AE-E	CD 3AA-L	24 - 47.6 - 12 20 - 3312-15	PG 15.5	30.22	94.24	1.22(31)	3.16(80)	25.56 87.22
CD 3NA-3L CD 3NE-E	C 3NA-E C 3NE-E	CD 3NA-L	24 - 47.6 - 12 20 - 3312-15	1/2" NPT	35.21	94.27	1.22(31)	3.16(80)	26.12 667.86 667.86
CD 6AA-3L CD 6AE-E	C 6AA-E C 6AE-E	CD 6AA-L	29 - 55.15-14 27 - 2712-15	70-6	38.22	97.22	1.22(31)	3.36(85)	28.56 84.21
CD21AA-3L CD21AE-E	C 2 1AA-E C 2 1AE-E	CD21AA-L	11 - 7 - 13-78 25 - 3312-14	70-21	1.12(28)	94.27	1.62(41)	4.27(111)	27.71 1.18(30)
CD22NA-3L CD22NE-E	C 2 2NA-E C 2 2NE-E	CD22NA-L	11 - 7 - 13-78 25 - 3312-14	3/4" NPT	1.08(27)	95.25	1.62(41)	4.27(111)	27.71 1.18(30)
CD29AA-3L CD29AE-E		CD29AA-L	71 - 28 - 18-26 31 - 3112-20	PG-28	1.47(37)	1.14(29)	1.69(43)	-	37.36 1.37(35)
CD36AA-3L CD36AE-E		CD36AA-L	97 - 42 - 22-22 70 - 1212-15	PG-36	1.81(47)	1.38(35)	1.69(43)	-	37.36 1.37(35)
CD42AA-3L CD42AE-E		CD42AA-L	1.26 - 1.80 - 22-22 8 - 1212-15	70-42	2.13(54)	1.63(41)	1.77(45)	-	38.26 2.24(57)
CD48AA-3L CD48AE-E		CD48AA-L	1.66 - 1.93 - 21-21 1.14 - 1.38 - 1212-32	70-48	2.51(63)	1.56(39)	1.81(46)	-	39.12 2.52(64)

**SPECIFICATIONS:**  
**Pressure rating:**  
 150 PSIG (10 BAR) NEMA 4x and 6  
 (Submersible) IP68  
**Materials:**  
 Body & Nut: Nickel Plated Brass  
 Spined Bushing: Nickel Plated Nylon (-FE)  
 Nylon (-BE)  
 Form Seal & O-Ring: Buna-N  
**Operating Temperature:**  
 -40°F to 212°F (-40°C to 100°C)

Dome Fittings

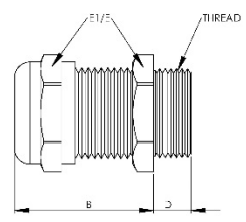

Flex Fittings

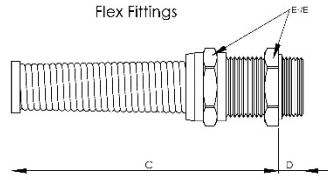

- NOTES:  
 1) GENERAL DIMENSIONS DRAWINGS.  
 2) DIMENSIONS [ ] ARE IN INCHES.  
 3) DIMENSIONS NOTED ARE FOR REFERENCE ONLY.

Third angle projection

14853 HINDSDALE AVE, SUITE D  
 CENTENNIAL, CO 80112-4240, USA  
 TEL: 1-303-699-1135  
 TOLL FREE: 1-800-456-9012  
 E-MAIL: info@scalconusa.com  
 WEB SITE: www.scalconusa.com

Liquid Tight Strain Relief Fittings, Elongated, Nickel Plated Brass, NPT Thread - Sealcon



LIQUID TIGHT STRAIN RELIEF FITTINGS / CORD GRIPS / CABLE GLANDS  
EMI/RFI PROOF - NICKEL PLATED BRASS - NPT THREADS

CONTACT US SITE MAP  
FOLLOW US:



[▶ 1/4" NPT](#)
[▶ 3/8" NPT](#)
[▶ 1/2" NPT](#)
[▶ 3/4" NPT](#)

**Easy Quote**  
Expand

**Request Catalogs / Samples**  
 (303) 699-1135  
 1-800-456-9012

**Strain Relief Fittings**

- ▶ Nylon Fittings
- ▼ Nickel Plated Brass Fittings
  - ▶ Standard Thread
  - ▶ Elongated Thread
  - ▶ Snap Elbow
  - ▶ Multi-Hole
  - ▶ Mini Wadi - Smallest Cable O.D.
  - ▶ Wadi XL - Largest Cable O.D.
  - ▶ High Performance - Clamp
  - ▶ High Performance - Clamp, Elongated Thread
- ▼ EMI/RFI (Standard)
  - ▶ PG Threads
  - ▼ NPT Threads
    - ▶ 1/4" NPT
    - ▶ 3/8" NPT
    - ▶ 1/2" NPT
    - ▶ 3/4" NPT
  - ▶ Metric Threads
- ▶ EMI/RFI (Standard), Elongated
- ▶ EMI/RFI (Standard), w/ Clamp
- ▶ EMI/RFI (Feed-Through)
- ▶ EMI/RFI (Feed-Through), Elongated Thread
- ▶ PVDF
- ▶ Stainless Steel
- ▶ Accessories

**Sealcon Closeout Stock Sale**

**Resources**

- Catalogs
- Flyers
- Industry Flyers
- Press Releases
- Product Videos

[Sealcon Home](#) | [Strain Relief Index](#) | [Nickel Plated Brass Fittings - EMI/RFI Proof \(Standard\) - NPT Threads](#)

**Strain Relief Fittings, Cord Grips, Cable Glands**  
EMI/RFI Proof Dome and Flex Fittings - 1/2" NPT Thread

[Strain Relief](#)
[Corresponding Accessories](#)
[Features](#)
[Technical Data](#)
[Other Accessories](#)

- Features:**
- Liquid Tight - Submersible to 300 ft. - NEMA 4x & 6 (IP68 / IP 69 K)
  - Highest Pressure Rating - Patented form seal guarantees 150 psig (10 bar)
  - Flame protected - V0 Rated according to UL 94
  - Halogen- and Phosphorous free materials
  - Large Selection - Cable Range from .08" (2mm) to 1.38" (35mm)
  - Non-Corrosive - Resistant to salt water, weak acids, weak alkalis, alcohol, esters, ketones, ether, gasoline, mineral, animal & vegetable oil.
  - Durable - Rugged Construction
  - Environmentally compliant - RoHS & Deca BDE

This EMI/RFI Proof Nickel Plated Brass Strain Relief with 1/2" NPT Thread will provide your application with a product made of exceptional quality.

Modularity: The Strain Relief allows you to increase and decrease the cable opening by just swapping out the standard and reduced inserts.

The self locking ACME thread on the dome and flex top ensures that the overlapping splines apply a concentric seal, thereby preventing the form seal from being pulled out of the fitting & ensuring pull-out protection of your cable without damaging it.

Kinking and chafing of the cable is eliminated with use of the Flex Nut.

**Assembly Instructions**



**Step 1**

- Strip cable
- Expose braided shield



**Step 2**

- Feed cable through dome nut and clamping insert
- Fold braided shield over clamping insert and O-ring
- Make sure that braided shield overlaps the O-ring by 3/32" (2 mm)



**Step 3**

- Push clamping insert into body and tighten dome nut
- Assemble into housing
- Finished



**WE PROVIDE CUSTOMERS WITH CABLE MANAGEMENT SOLUTIONS!**

-Quantity Discounts!      -No Minimum Orders!      -Same Day Shipping!  
 -Blanket Orders!          -Quick and Friendly Service!      -All Major Credit Cards!

Search

**2D/3D CAD DOWNLOAD**



Click the button below to view download options.  
Click again to close the section.

[CD13NR-BE](#)  
[CD13NR-BE](#)  
[CF13NR-BE](#)  
[CF13NR-BE](#)

[Data Sheet](#)

**Dimensions and Specifications may change without prior notice**

Questions?

[Click To Chat!](#)

Liquid Tight Strain Relief Fittings, Elongated, Nickel Plated Brass, NPT Thread - Sealcon

<b>Advertisements</b>
<b>Product News</b>
<b>Product Applications</b>
<b>Technical Info</b>
<b>Strain Relief Fittings, Conduit &amp; Accessories</b>
<b>Circular Connectors</b>
<b>Enclosures</b>
<b>Products By Industry</b>
<b>Certificates / Approvals</b>
<b>FAQ</b>
<b>Benefits &amp; Features</b>
<b>Why Choose Sealcon</b>
<b>Ex Hazardous Glands</b>
<b>EXIOS Armored</b>
<b>EXIOS Armored + Barrier</b>
<b>Nylon Cable Glands</b>
<b>Nickel Plated Brass</b>
<b>INOX Stainless Steel</b>
<b>Circular Connectors</b>
<b>Accessories</b>

THE EXCLUSIVE IMPORTER OF



**HI-TECH CONTROLS, INC.** provides cable products at competitive prices with exemplary customer service. Inventory in Excess of \$25 Million allows the immediate shipment of almost all standard cable types and sizes.

**Cables, Wires & Accessories: Domestic & Imported**  
 Importer of **HELLUKABEL®**. Approvals: RoHS, UL, CSA, Harmonized & CE. We offer cables for Power, Control, High/Low Temp., Hi-Flex, Robotic, Track, Servo, VFD, Composite, Ribbon, Data(CAT), Single Conductor, etc!

**Plastic Enclosures: Indoor / Outdoor NEMA 4x**  
 Exclusive importer of **HENSEL ENCLOSURES**. Industrial Strength, UV & Impact Resistant, Modular Expandable.  
**Materials:** Polycarbonate, Polystyrene, Powder-coated Steel  
**Types:** Gray or Transparent Lids, available with Hinges & Latches, Opaque/ Transparent covers, Plain Walls or Knockouts, Hazardous Location, Fire Proof / Functional Integrity, Offshore Applications (Saltwater-proof)  
**Accessories:** DIN rails, Mounting plates, Terminal blocks, Hole plugs, etc.

**Aluminum Enclosures: Custom**  
 Custom Customize your own Control Solution Device with the following Cord Grips, Momentary Push Buttons, etc.  
 NEMA Enclosure Rating: 4, 4x (IP66). We offer 1, 2 and 3 Button Solutions. Industrial Enclosures are made of Powder Coated Gray Die Cast Aluminum alloy. We do the assembly at one low price.

**Pneumatic Components: Fittings, Tubing, Valves & Gauges**  
**Fittings:** Nickel Plated Brass, Composite, Brass & Compression Fittings, the patented & longstanding Pro-Fit® system, High Pressure Dual Seal fittings, etc.  
**Valves:** Flow Control, Manual, Air Piloted, Solenoid, Brass  
 We also offer **Tubing, FRL Units (Filters, Regulators & Lubricators), Gauges, Timers and Relays**. Manufacturers include **CAMOZZI, COUPLINGS COMPANY, PNEUMADYNE, INFITEC**, etc.

7374 S. Eagle Street  
 Centennial, CO 80112-4221 USA  
 Toll Free: 800-456-9012 / 303-699-1135 Fax: 303-680-5344

WCC CERTIFIED 2.0

Top of Page

Copyright © 2012 Sealcon LLC All Rights Reserved

[|Strain Relief Fittings|](#)[Strain Relief for Hazardous Areas|](#)[Circular Connectors|](#)[Enclosures|](#)[Conduit System|](#)[Adapter, Enlarger, Reducer|](#)[Accessories|](#)  
[|Product Index|](#)[Media|](#)[Online Catalog|](#)[Company Overview|](#)[Contact|](#)[Privacy Policy|](#)[Email Us|](#)  
[|Copyright Notice|](#)[Site Map|](#)[Search|](#)[Quote Request|](#)



## **Addendum B: Agency Approvals**

[cFMus Certificate](#)

[ATEX Certificate](#)

[IECEx Certificate](#)

[cFMus Canadian Certificate](#)

[CE Certificate](#)